

Applied Biosystems 2720 Thermal Cycler

For Amplification of Nucleic Acids

User Guide

For Research Use Only. Not intended for any animal or human therapeutic or diagnostic use.

© Copyright 2010 Applied Biosystems. All rights reserved.

NOTICE TO PURCHASER: Label License

The Applied Biosystems 2720 Thermal Cycler is covered by US patent claims, and corresponding claims in their non-US counterparts. No right is conveyed expressly, by implication, or by estoppel under any other patent claim, such as claims to apparatus, reagents, kits, or methods such as 5' nuclease methods. Further information on purchasing licenses may be obtained by contacting the Director of Licensing, Applied Biosystems, 850 Lincoln Centre Drive, Foster City, California 94404, USA.

The trademarks mentioned herein are the property of Applied Biosystems or their respective owners.

AmpErase, AmpliTaq, AmpliTaq Gold, EnviroAmp, GeneAmp, and TaqMan are registered trademarks of Roche Molecular Systems, Inc.

Microsoft, Windows, and Windows NT are registered trademarks of Microsoft Corporation.

The information contained in this document is subject to change without notice.

Produced 11/2010

Part Number 4359453, Rev. F

Contents

Preface

How to Use This Guide	vii
How to Obtain More Information.	viii
How to Obtain Support.	viii

Safety and EMC Compliance Information

Safety Conventions Used in This Document	x
Symbols on Instruments	xi
Safety Labels on Instruments	xii
Instrument Warnings Diagram	xiv
General Instrument Safety	xv
Chemical Safety	xv
Chemical Waste Safety.	xvii
Electrical Safety	xviii
Laboratory Environmental Requirements	xx
Physical Hazard Safety.	xx
Safety and Electromagnetic Compatibility (EMC) Standards	xxi

1 System Overview

Overview	1-1
Introducing the Applied Biosystems 2720 Thermal Cycler.	1-2
About the Control Panel	1-4
Overview of Functions	1-5
Introducing an Important Screen	1-6

2 Getting Started

Overview	2-1
Powering On.	2-2
Adding Yourself as a User	2-3
Creating a Method	2-5
Editing Your Method	2-7
Starting and Stopping a Run.	2-8
More Features.	2-10

3	<i>Runs</i>	
	Overview	3-1
	Using Disposables	3-2
	Loading Samples	3-5
	Starting a Run	3-7
	Pausing or Stopping a Run	3-9
	Reviewing the History of a Run	3-11
	When a Run Completes	3-13
4	<i>Methods and Users</i>	
	Overview	4-1
	Adding, Changing, or Deleting a User Name	4-2
	Creating a Method	4-6
	Changing a Method Using Advanced Features	4-9
	Handling Methods	4-18
5	<i>Utilities</i>	
	Overview	5-1
	Configuring the Instrument	5-2
	Upgrading System Firmware	5-4
	Connecting to a Printer	5-5
	Calculating the Melting Temperature	5-6
	Running Hardware Diagnostics	5-7
	Running the Calibration Verification Test	5-9
	Running the Temperature Non-Uniformity Test	5-9
	Running System Performance Diagnostics	5-10
6	<i>Maintenance</i>	
	Overview	6-1
	Cleaning the Instrument	6-2
	Replacing Fuses	6-4
7	<i>Troubleshooting</i>	
	Overview	7-1
	If There's a Power Failure	7-2
	Display Screen Error Messages	7-3
	Troubleshooting Information	7-6

A Specifications

Overview	A-1
System Specifications	A-2
Control Panel Specifications	A-2
Sample Temperature Information	A-3
Printer Specifications	A-3

B Supplied Methods

Overview	B-1
About the Methods	B-2

C Screen Flowcharts

Overview	C-1
Run	C-2
Stop or End of Run	C-3
Create/Edit	C-4
User	C-5
Utilities	C-6
Diagnostics	C-7
Upgrade	C-8

D Instrument Warranty Information

Overview	D-1
Computer Configuration	D-2
Limited Product Warranty	D-2
Damages, Claims, and Returns	D-4

Index

Preface

How to Use This Guide

Purpose of This Guide The *Applied Biosystems 2720 Thermal Cycler User Manual* describes how to use the Applied Biosystems 2720 Thermal Cycler. The user manual provides information about performing runs and diagnostic tests as well as maintenance and troubleshooting.

Text Conventions This guide uses the following conventions:

- **Bold** indicates user action. For example:
Type **0**, then press **Enter** for each of the remaining fields.
- *Italic* text indicates new or important words and is also used for emphasis. For example:
Before analyzing, *always* prepare fresh matrix.
- A right arrow bracket (>) separates successive commands you select from a drop-down or shortcut menu. For example:
Select **File > Open > Spot Set**.
Right-click the sample row, then select **View Filter > View All Runs**.

User Attention Words Two user attention words appear in Applied Biosystems user documentation. Each word implies a particular level of observation or action as described below:

Note: Provides information that may be of interest or help but is not critical to the use of the product.

IMPORTANT! Provides information that is necessary for proper instrument operation, accurate chemistry kit use, or safe use of a chemical.

Examples of the user attention words appear below:

Note: The size of the column affects the run time.

Note: The Calibrate function is also available in the Control Console.

IMPORTANT! To verify your client connection to the database, you need a valid Oracle user ID and password.

IMPORTANT! You must create a separate Sample Entry Spreadsheet for each 96-well plate.

Safety Alert Words Safety alert words also appear in user documentation. For more information, see “[Safety Alert Words](#)” on [page x](#).

How to Obtain More Information

Related Documentation

The following related document is shipped with the system:

Applied Biosystems 2720 Thermal Cycler Quick Reference Card – Provides brief, step-by-step procedures for using the 2720 Thermal Cycler. It is designed to help you quickly learn to use the 2720 Thermal Cycler.

Portable document format (PDF) versions of this guide and the *Applied Biosystems 2720 Thermal Cycler Quick Reference Card* are also available on the *Applied Biosystems 2720 Thermal Cycler* software installation CD.

Note: For additional documentation, see “[How to Obtain Support](#)” below.

Send Us Your Comments

Applied Biosystems welcomes your comments and suggestions for improving its user documents. You can e-mail your comments to:

techpubs@appliedbiosystems.com

How to Obtain Support

For the latest services and support information for all locations, go to <http://www.appliedbiosystems.com>, then click the link for **Support**.

At the Support page, you can:

- Search through frequently asked questions (FAQs)
- Submit a question directly to Technical Support
- Order Applied Biosystems user documents, MSDSs, certificates of analysis, and other related documents
- Download PDF documents
- Obtain information about customer training
- Download software updates and patches

In addition, the Support page provides access to worldwide telephone and fax numbers to contact Applied Biosystems Technical Support and Sales facilities.

Safety and EMC Compliance Information

This section includes the following topics:

Safety Conventions Used in This Document.	x
Symbols on Instruments	xi
Safety Labels on Instruments	xii
Instrument Warnings Diagram	xiv
General Instrument Safety.	xv
Chemical Safety	xv
Chemical Waste Safety	xvii
Electrical Safety	xviii
Laboratory Environmental Requirements	xx
Physical Hazard Safety	xx
Safety and Electromagnetic Compatibility (EMC) Standards	xxi

Safety Conventions Used in This Document

Safety Alert Words

Four safety alert words appear in Applied Biosystems user documentation at points in the document where you need to be aware of relevant hazards. Each alert word—**IMPORTANT**, **CAUTION**, **WARNING**, **DANGER**—implies a particular level of observation or action, as defined below:

Definitions

IMPORTANT! – Indicates information that is necessary for proper instrument operation, accurate chemistry kit use, or safe use of a chemical.

 **CAUTION** – Indicates a potentially hazardous situation that, if not avoided, may result in minor or moderate injury. It may also be used to alert against unsafe practices.

 **WARNING** – Indicates a potentially hazardous situation that, if not avoided, could result in death or serious injury.

 **DANGER** – Indicates an imminently hazardous situation that, if not avoided, will result in death or serious injury. This signal word is to be limited to the most extreme situations.

Except for **IMPORTANT**s, each safety alert word in an Applied Biosystems document appears with an open triangle figure that contains a hazard symbol. *These hazard symbols are identical to the hazard icons that are affixed to Applied Biosystems instruments (see “[Safety Symbols](#)” on [page xi](#)).*

Examples

The following examples show the use of safety alert words:

IMPORTANT! You must create a separate a Sample Entry Spreadsheet for each 96-well plate.

 **CAUTION** The lamp is extremely hot. Do not touch the lamp until it has cooled to room temperature.







 **WARNING** **CHEMICAL HAZARD. Formamide.** Exposure causes eye, skin, and respiratory tract irritation. It is a possible developmental and birth defect hazard. Read the MSDS, and follow the handling instructions. Wear appropriate protective eyewear, clothing, and gloves.

 **DANGER** **ELECTRICAL HAZARD.** Failure to ground the instrument properly can lead to an electrical shock. Ground the instrument according to the provided instructions.

Symbols on Instruments



Electrical Symbols on Instruments



The following table describes the electrical symbols that may be displayed on Applied Biosystems instruments.

Symbol	Description
	Indicates the On position of the main power switch.
	Indicates the Off position of the main power switch.
	Indicates the On/Off position of a push-push main power switch.
	Indicates a terminal that may be connected to the signal ground reference of another instrument. This is not a protected ground terminal.
	Indicates a protective grounding terminal that must be connected to earth ground before any other electrical connections are made to the instrument.
	Indicates a terminal that can receive or supply alternating current or voltage.
	Indicates a terminal that can receive or supply alternating or direct current or voltage.

Safety Symbols

The following table describes the safety symbols that may be displayed on Applied Biosystems instruments. Each symbol may appear by itself or in combination with text that explains the relevant hazard (see [“Safety Labels on Instruments”](#) on page xii). These safety symbols may also appear next to DANGERS, WARNINGS, and CAUTIONS that occur in the text of this and other product-support documents.

Symbol	Description
	Indicates that you should consult the manual for further information and to proceed with appropriate caution.
	Indicates the presence of an electrical shock hazard and to proceed with appropriate caution.
	Indicates the presence of a hot surface or other high-temperature hazard and to proceed with appropriate caution.

Symbol	Description
	Indicates the presence of a laser inside the instrument and to proceed with appropriate caution.
	Indicates the presence of moving parts and to proceed with appropriate caution.

Safety Labels on Instruments

The following CAUTION, WARNING, and DANGER statements may be displayed on Applied Biosystems instruments in combination with the safety symbols described in the preceding section.





English	Francais
CAUTION Hazardous chemicals. Read the Material Safety Data Sheets (MSDSs) before handling.	ATTENTION Produits chimiques dangereux. Lire les fiches techniques de sûreté de matériels avant la manipulation des produits.
CAUTION Hazardous waste. Read the waste profile (if any) in the site preparation guide for this instrument before handling or disposal.	ATTENTION Déchets dangereux. Lire les renseignements sur les déchets avant de les manipuler ou de les éliminer.
CAUTION Hazardous waste. Refer to MSDS(s) and local regulations for handling and disposal.	ATTENTION Déchets dangereux. Lire les fiches techniques de sûreté de matériels et la réglementation locale associées à la manipulation et l'élimination des déchets.
WARNING Hot lamp.	AVERTISSEMENT Lampe brûlante.
WARNING Hot. Replace lamp with an Applied Biosystems lamp.	AVERTISSEMENT Composants brûlants. Remplacer la lampe par une lampe Applied Biosystems.
CAUTION Hot surface.	ATTENTION Surface brûlante.
DANGER High voltage.	DANGER Haute tension.
WARNING To reduce the chance of electrical shock, do not remove covers that require tool access. No user-serviceable parts are inside. Refer servicing to Applied Biosystems qualified service personnel.	AVERTISSEMENT Pour éviter les risques d'électrocution, ne pas retirer les capots dont l'ouverture nécessite l'utilisation d'outils. L'instrument ne contient aucune pièce réparable par l'utilisateur. Toute intervention doit être effectuée par le personnel de service qualifié de Applied Biosystems.

English	Français
<p>DANGER Class <<3B, 3R, or 4>> laser radiation present when open and interlock defeated. Avoid direct exposure to laser beam.</p>	<p>DANGER Class <<3B, 3R, or 4>> rayonnement laser en cas d'ouverture et d'une neutralisation des dispositifs de sécurité. Eviter toute exposition directe avec le faisceau.</p>
<p>DANGER Class <<3B, 3R, or 4>> laser radiation when open. Avoid direct exposure to laser beam.</p>	<p>DANGER Class <<3B, 3R, or 4>> rayonnement laser en cas d'ouverture. Eviter toute exposition directe avec le faisceau.</p>
<p>DANGER Class <<2 (II), 3B, 3R, or 4>> laser radiation present when open and interlock defeated. Do not stare directly into the beam</p>	<p>DANGER de Class <<2 (II), 3B, 3R, or 4>> rayonnement laser en cas d'ouverture et d'une neutralisation des dispositifs de sécurité. Eviter toute exposition directe avec le faisceau.</p>
<p>DANGER Class <<2 (II), 3B, 3R, or 4>> laser radiation present when open. Do not stare directly into the beam.</p>	<p>DANGER de Class <<2 (II), 3B, 3R, or 4>> rayonnement laser en cas d'ouverture. Eviter toute exposition directe avec le faisceau.</p>
<p>DANGER Class <<2 (II), 3B, 3R, or 4>> LED when open and interlock defeated. Do not stare directly into the beam.</p>	<p>DANGER de Class <<2 (II), 3B, 3R, or 4>> LED en cas d'ouverture et d'une neutralisation des dispositifs de sécurité. Eviter toute exposition directe avec le faisceau.</p>
<p>DANGER Class <<2 (II), 3B, 3R, or 4>> LED when open. Do not stare directly into the beam.</p>	<p>DANGER de Class <<2 (II), 3B, 3R, or 4>> LED en cas d'ouverture. Eviter toute exposition directe avec le faisceau.</p>
<p>CAUTION Moving parts.</p>	<p>ATTENTION Parties mobiles.</p>

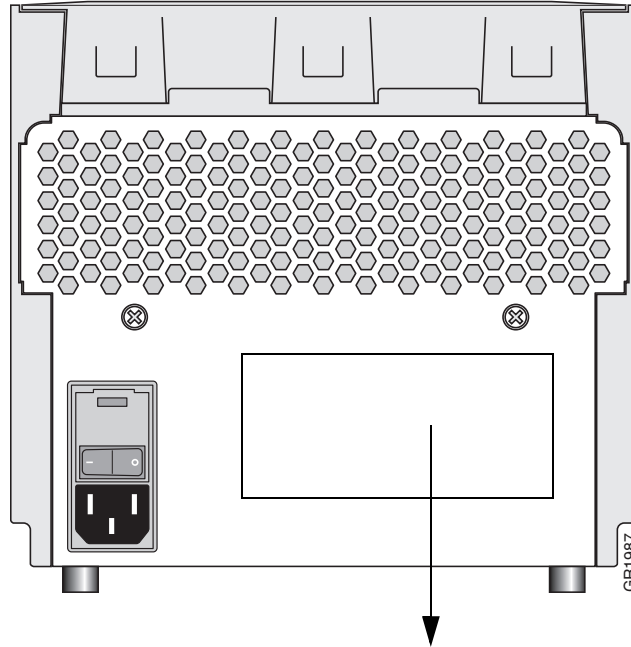
Instrument Warnings Diagram

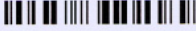
The following diagram shows where the hazards and warnings labels are located on rear of the 2720 Thermal Cycler.



<p>Electrical Rating: <u>100 - 240 VAC ~</u> 50/60 Hz; Max. Power 420 VA</p> <p>Fuse Rating: <u>8 A, 250 VAC, SB(T)</u> Replace only with same TYPE and RATING FUSE</p> <p>DO NOT OPEN PANELS OR COVERS</p> <p style="text-align: right; font-size: small;">4359660</p>	<p>AB Applied Biosystems Applied Biosystems 2720 Thermal Cycler</p> <p>Part No: 4359659 </p> <p>Serial No: 272SYMMDD00 </p> <p>MFG: XXXXXXXXXXXX XXXX</p> <p>LISTED Laboratory Use Electrical Equipment 3Z77; EN61326, Group 1, Class B</p> <hr/> <p>  </p> <p>Made in Singapore</p> <p style="text-align: right; font-size: small;">4359660</p>
---	---

General Instrument Safety

Moving and Lifting the Instrument

**CAUTION****PHYSICAL INJURY HAZARD.**

The instrument is to be moved and positioned only by the personnel or vendor specified in the applicable site preparation guide. If you decide to lift or move the instrument after it has been installed, do not attempt to lift or move the instrument without the assistance of others, the use of appropriate moving equipment, and proper lifting techniques. Improper lifting can cause painful and permanent back injury. Depending on the weight, moving or lifting an instrument may require two or more persons.

Operating the Instrument

Ensure that anyone who operates the instrument has:

- Received instructions in both general safety practices for laboratories and specific safety practices for the instrument.
- Read and understood all applicable Material Safety Data Sheets (MSDSs). See “About MSDSs” on [page xvi](#).

**WARNING****PHYSICAL INJURY HAZARD.**

Use this instrument as specified by Applied Biosystems. Using this instrument in a manner not specified by Applied Biosystems may result in personal injury or damage to the instrument.

Chemical Safety

Chemical Hazard Warning

**WARNING****CHEMICAL HAZARD.**

Before handling any chemicals, refer to the Material Safety Data Sheet (MSDS) provided by the manufacturer, and observe all relevant precautions.

**WARNING****CHEMICAL HAZARD.**

All chemicals in the instrument, including liquid in the lines, are potentially hazardous. Always determine what chemicals have been used in the instrument before changing reagents or instrument components. Wear appropriate eyewear, protective clothing, and gloves when working on the instrument.

**WARNING****CHEMICAL HAZARD.**

Four-liter reagent and waste bottles can crack and leak. Each 4-liter bottle should be secured in a low-density polyethylene safety container with the cover fastened and the handles locked in the upright position. Wear appropriate eyewear, clothing, and gloves when handling reagent and waste bottles.

**WARNING****CHEMICAL STORAGE HAZARD.**

Never collect or store waste in a glass container because of the risk of breaking or shattering. Reagent and waste bottles can crack and leak. Each waste bottle should be secured in a low-density polyethylene safety container with the cover fastened and the handles locked in the upright position. Wear appropriate eyewear, clothing, and gloves when handling reagent and waste bottles.

About MSDSs

Chemical manufacturers supply current Material Safety Data Sheets (MSDSs) with shipments of hazardous chemicals to *new* customers. They also provide MSDSs with the first shipment of a hazardous chemical to a customer after an MSDS has been updated. MSDSs provide the safety information you need to store, handle, transport, and dispose of the chemicals safely.

Each time you receive a new MSDS packaged with a hazardous chemical, be sure to replace the appropriate MSDS in your files.

Obtaining MSDSs

You can obtain from Applied Biosystems the MSDS for any chemical supplied by Applied Biosystems. This service is free and available 24 hours a day.

To obtain MSDSs:

1. Go to <https://docs.appliedbiosystems.com/msdssearch.html>
2. In the Search field, type in the chemical name, part number, or other information that appears in the MSDS of interest. Select the language of your choice, then click **Search**.
3. Find the document of interest, right-click the document title, then select any of the following:
 - **Open** – To view the document
 - **Print Target** – To print the document
 - **Save Target As** – To download a PDF version of the document to a destination that you choose
4. To have a copy of a document sent by fax or e-mail, select **Fax** or **Email** to the left of the document title in the Search Results page, then click **RETRIEVE DOCUMENTS** at the end of the document list.
5. After you enter the required information, click **View/Deliver Selected Documents Now**.

Chemical Safety Guidelines

To minimize the hazards of chemicals:

- Read and understand the Material Safety Data Sheets (MSDS) provided by the chemical manufacturer before you store, handle, or work with any chemicals or hazardous materials. (See “About MSDSs” on page xvi.)
- Minimize contact with chemicals. Wear appropriate personal protective equipment when handling chemicals (for example, safety glasses, gloves, or protective clothing). For additional safety guidelines, consult the MSDS.
- Minimize the inhalation of chemicals. Do not leave chemical containers open. Use only with adequate ventilation (for example, fume hood). For additional safety guidelines, consult the MSDS.
- Check regularly for chemical leaks or spills. If a leak or spill occurs, follow the manufacturer’s cleanup procedures as recommended on the MSDS.
- Comply with all local, state/provincial, or national laws and regulations related to chemical storage, handling, and disposal.

Chemical Waste Safety

Chemical Waste Hazard



CAUTION HAZARDOUS WASTE. Refer to Material Safety Data Sheets and local regulations for handling and disposal.



WARNING CHEMICAL WASTE HAZARD. Wastes produced by Applied Biosystems instruments are potentially hazardous and can cause injury, illness, or death.



WARNING CHEMICAL STORAGE HAZARD. Never collect or store waste in a glass container because of the risk of breaking or shattering. Reagent and waste bottles can crack and leak. Each waste bottle should be secured in a low-density polyethylene safety container with the cover fastened and the handles locked in the upright position. Wear appropriate eyewear, clothing, and gloves when handling reagent and waste bottles.

Chemical Waste Safety Guidelines

To minimize the hazards of chemical waste:

- Read and understand the Material Safety Data Sheets (MSDSs) provided by the manufacturers of the chemicals in the waste container before you store, handle, or dispose of chemical waste.
- Provide primary and secondary waste containers. (A primary waste container holds the immediate waste. A secondary container contains spills or leaks from the primary container. Both containers must be compatible with the waste material and meet federal, state, and local requirements for container storage.)
- Minimize contact with chemicals. Wear appropriate personal protective equipment when handling chemicals (for example, safety glasses, gloves, or protective clothing). For additional safety guidelines, consult the MSDS.
- Minimize the inhalation of chemicals. Do not leave chemical containers open. Use only with adequate ventilation (for example, fume hood). For additional safety guidelines, consult the MSDS.
- Handle chemical wastes in a fume hood.
- After emptying the waste container, seal it with the cap provided.
- Dispose of the contents of the waste tray and waste bottle in accordance with good laboratory practices and local, state/provincial, or national environmental and health regulations.

Waste Disposal

If potentially hazardous waste is generated when you operate the instrument, you must:

- Characterize (by analysis if necessary) the waste generated by the particular applications, reagents, and substrates used in your laboratory.
- Ensure the health and safety of all personnel in your laboratory.
- Ensure that the instrument waste is stored, transferred, transported, and disposed of according to all local, state/provincial, and/or national regulations.

IMPORTANT! Radioactive or biohazardous materials may require special handling, and disposal limitations may apply.

Electrical Safety

Grounding  **DANGER ELECTRICAL SHOCK HAZARD.** Grounding circuit continuity is vital for the safe operation of equipment. Never operate equipment with the grounding conductor disconnected

 **DANGER ELECTRICAL SHOCK HAZARD.** Do not use an adapter to a two-terminal outlet since this does not provide positive ground protection.

Fuses  **DANGER ELECTRICAL SHOCK HAZARD.** Improper fuses or line voltage supply can damage the instrument wiring system and cause a fire. Before turning on the instrument, verify that the fuses are properly installed and that the instrument voltage matches the power supply in your laboratory.

 **WARNING FIRE HAZARD.** For continued protection against the risk of fire, replace fuses only with fuses of the type and rating specified for the instrument.

Power  **DANGER ELECTRICAL HAZARD.** Use properly configured and approved line cords for the voltage supply in your facility.

 **DANGER ELECTRICAL HAZARD.** Plug the system into a properly grounded receptacle with adequate current capacity.

Overvoltage Rating The Applied Biosystems 2720 Thermal Cycler has an installation (overvoltage) category of II, and is classified as portable equipment

Electrical Shock Hazard  **WARNING ELECTRICAL SHOCK HAZARD.** To reduce the chance of electrical shock, do not remove covers that require tool access. No user-serviceable parts are inside. Refer servicing to Applied Biosystems qualified service personnel.

AVERTISSEMENT: Pour réduire le risque de chocs électriques, ne pas ouvrir les couvercles si un outil est nécessaire. Ne contient aucune pièce pouvant être réparée par l'utilisateur. Confier le dépannage au personnel qualifié de Applied Biosystems.

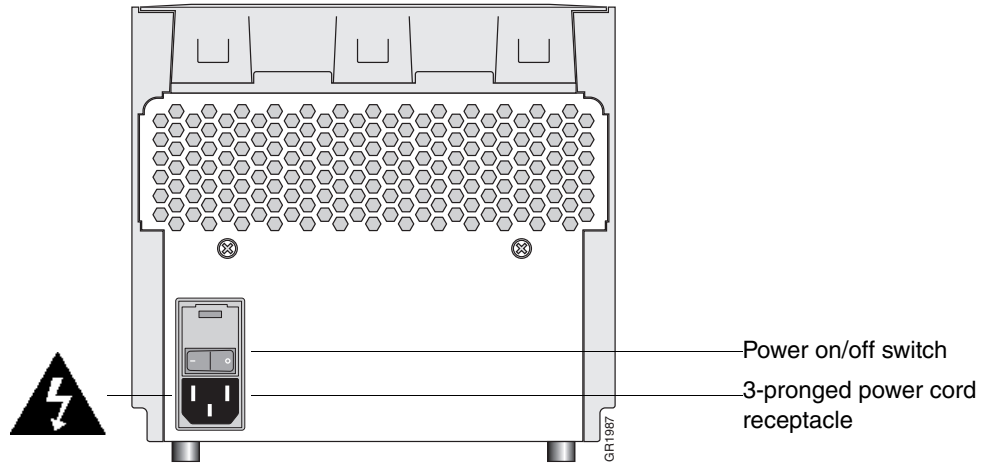

The 3-pronged power cord and receptacle at the instrument rear contain the grounding connector.

 **WARNING ELECTRICAL SHOCK HAZARD.** Severe electrical shock, which could cause physical injury or death, can result from working on an instrument when the high voltage power supply is operating. To avoid electrical shock, disconnect the power supply to the instrument, unplug the power cord, and wait at least 1 minute before working on the instrument.

AVERTISSEMENT: Pour éviter les chocs électriques, débrancher le cordon d'alimentation avant le dépannage.

Fire Hazard

 **WARNING FIRE HAZARD.** For continued protection against the risk of fire, replace fuses only with Listed and Certified fuses of the same type and rating as those currently in the instrument.

AVERTISSEMENT: Afin d'assurer la protection contre les risques d'incendie, remplacer uniquement par un fusible de même type et de même courant nominal.

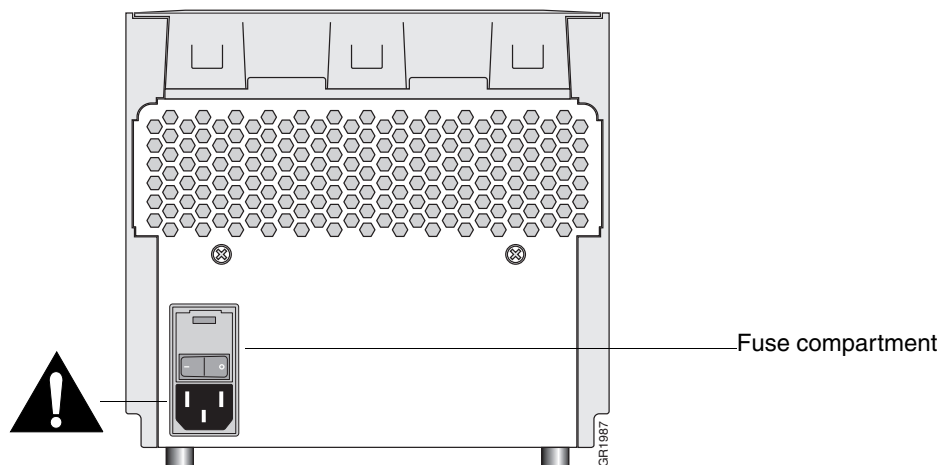

Laboratory Environmental Requirements

Temperature, Humidity, and Environment

IMPORTANT This instrument is designed for indoor use.

IMPORTANT Do not operate in a Cold Room or a refrigerated area. The 2720 Thermal Cycler will operate safely when the ambient temperature is 5 °C to 40 °C (41 °F to 104 °F) and will meet performance specifications when the ambient temperature is 15 °C to 30 °C and the ambient relative humidity is 20 to 80%. These specifications have been calculated for altitudes between 0 and 2,000 meters.



WARNING FIRE HAZARD. This instrument is not designed for operation in an explosive environment. Do not place the instrument close to potentially explosive materials or objects.

IMPORTANT The instrument should be stored between –20 °C and 60 °C (–4 °F and 140 °F) at altitudes between 0 and 12,000 meters.

Note This instrument is able to withstand transient overvoltage according to Installation Category II as defined in IEC 1010-1.

Physical Hazard Safety

Moving Parts



WARNING PHYSICAL INJURY HAZARD. Moving parts can crush and cut. Keep hands clear of moving parts while operating the instrument. Disconnect power before servicing the instrument.

Danger of Burns



WARNING PHYSICAL INJURY HAZARD. Hot Surface. Use care when working around this area to avoid being burned by hot components.

AVERTISSEMENT: Surface chaude.

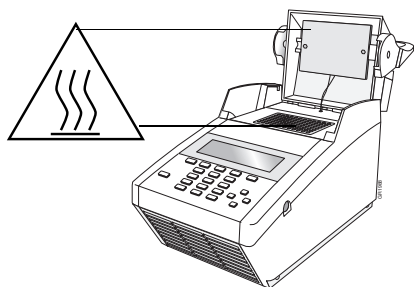

Safety and Electromagnetic Compatibility (EMC) Standards

This section provides information on:

- [U.S. and Canadian Safety Standards](#)
- Canadian EMC Standard
- [European Safety and EMC Standards](#)
- [Australian EMC Standards](#)

U.S. and Canadian Safety Standards

This instrument has been tested to and complies with standard UL 3101-1, “Safety Requirements for Electrical Equipment for Laboratory Use, Part 1: General Requirements.”



This instrument has been tested to and complies with standard CSA 1010.1, “Safety Requirements for Electrical Equipment for Measurement, Control, and Laboratory Use, Part 1: General Requirements.”

Canadian EMC Standard

This instrument has been tested to and complies with ICES-001, Issue 3: Industrial, Scientific, and Medical Radio Frequency Generators.

European Safety and EMC Standards

Safety

This instrument meets European requirements for safety (Low Voltage Directive 73/23/EEC). This instrument has been tested to and complies with standards EN 61010-1:2001, “Safety Requirements for Electrical Equipment for Measurement, Control and Laboratory Use, Part 1: General Requirements” and EN 61010-2-010, “Particular Requirements for Laboratory Equipment for the Heating of Materials.”



EMC

This instrument meets European requirements for emission and immunity (EMC Directive 89/336/EEC). This instrument has been tested to and complies with standard EN 61326 (Group 1, Class B), “Electrical Equipment for Measurement, Control and Laboratory Use – EMC Requirements.”

Australian EMC Standards



This instrument has been tested to and complies with standard AS/NZS 2064, “Limits and Methods Measurement of Electromagnetic Disturbance Characteristics of Industrial, Scientific, and Medical (ISM) Radio-frequency Equipment.”

System Overview

1

Overview

About This Chapter This chapter provides an introductory overview to the Applied Biosystems 2720 Thermal Cycler.

In This Chapter This chapter contains the following topics:

Topic	See Page
Introducing the Applied Biosystems 2720 Thermal Cycler	1-2
About the Control Panel	1-4
Overview of Functions	1-5
Introducing an Important Screen	1-6

Introducing the Applied Biosystems 2720 Thermal Cycler

About the Instrument The Applied Biosystems 2720 Thermal Cycler is an automated instrument, specifically designed for the amplification of nucleic acids using the GeneAmp Polymerase Chain Reaction (PCR) process.

The instrument has an integrated 96-well sample block, which houses an internal Peltier heating/cooling unit. The sample block is made of aluminum to provide optimal thermal transfer rate.

Platinum sensors provide:

- ◆ Wide temperature range: 4 °C to 99.9 °C
- ◆ Accuracy: ± 0.25 °C from 35 °C to 99.9 °C
- ◆ Long term stability and high reliability

The sample block accommodates several different types of MicroAmp® disposable tubes and plates, which must be used in order to create a sealed chamber.

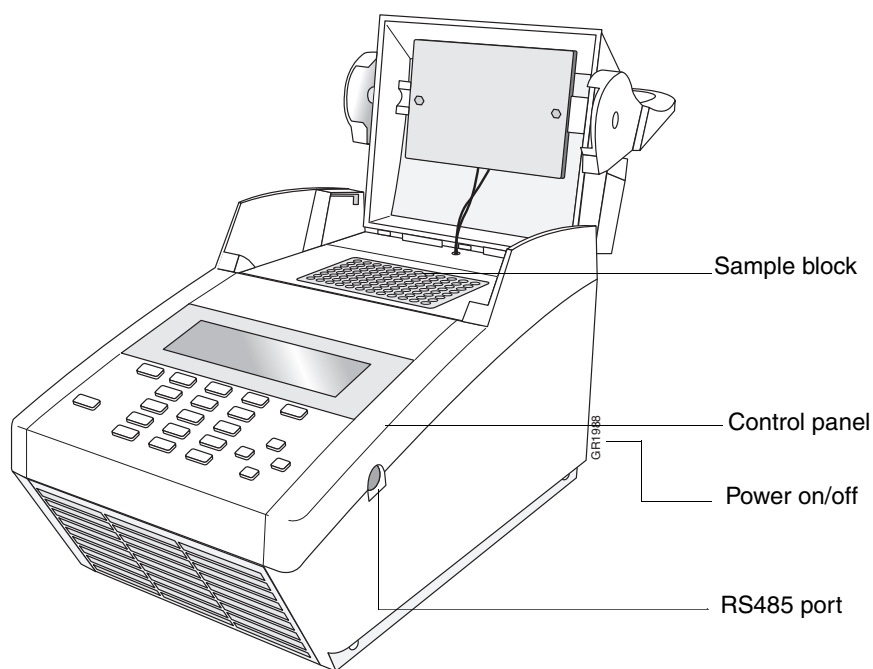

The 2720 Thermal Cycler has an easy-to-use, intuitive user interface, which is described in “About the Control Panel” on page 1-4.

**Comparing the
2720 Thermal Cycler
to Previous
Instruments**

The 2720 Thermal Cycler can be compared to the GeneAmp® PCR System 9700, as shown below:

2720 Thermal Cycler	System 9700
<ul style="list-style-type: none">◆ Almost the same user interface as previous instruments◆ Integrated sample block◆ Uses same disposables as 96-well sample block on system 9700◆ Small footprint◆ Instruments can be “packed” side-by-side on a bench because the air flows out the back, rather than the sides.	<ul style="list-style-type: none">◆ Interchangeable sample blocks with 60, 96, or dual-384 wells◆ Networking capabilities◆ High “instrument diagnostics” capabilities◆ Variable ramp rates and cycling speeds◆ PCMCIA slot for software upgrade and Methods Transportability card

About the Control Panel

Overview The control panel for the 2720 Thermal Cycler consists of a display screen and keys, including function keys (F1–F5), numeric keys, arrow keys, and the Enter, CE, and Stop keys, as shown in the figure below.

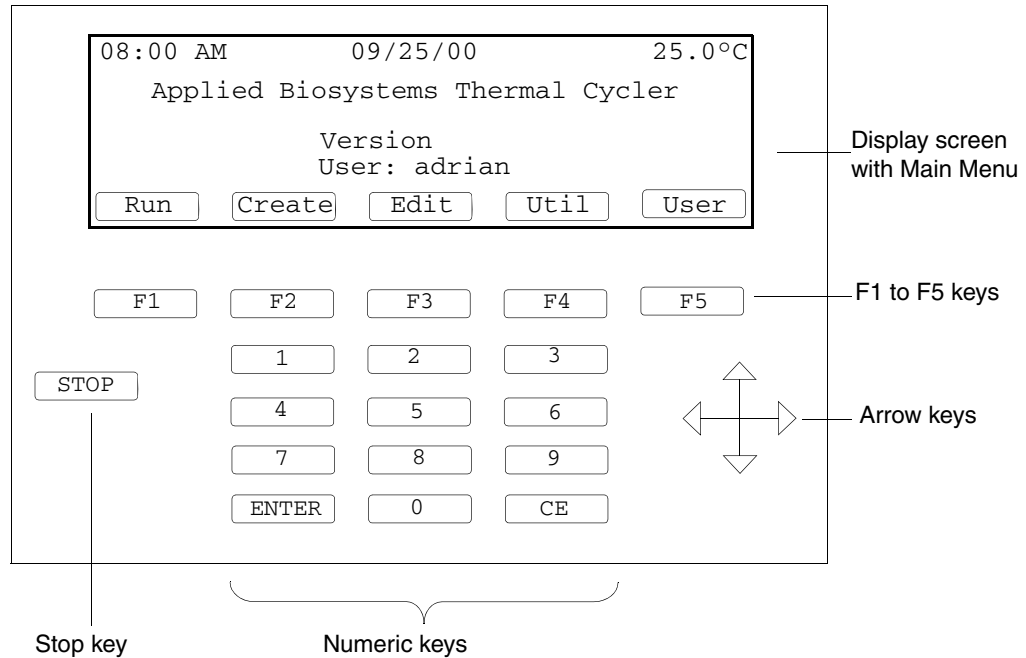

Display The display screen is a window that you use for communicating with the instrument's software.

F1 to F5 Keys Use the function keys (F1 to F5) to activate the “button” on the screen above the key; for example, F1 for Run. The display is not a touch screen. Throughout this manual you will find instructions to press F1 (Run) or press F2 (Create). The function keys permit you to navigate from screen to screen and perform other actions.

Selecting a Field Most screens have a highlighter that you use to select a field. To move the highlighter, use the arrow keys or the Enter key.

Entering Numbers Use the numeric keys (0–9) to enter numeric values, then press Enter or an arrow key. When you type temperatures and times (minutes:seconds), the system takes care of the decimal point and colon, respectively. If necessary, you can use the CE key to clear a field and then reenter values.

Overview of Functions

Main Menu as Base The Main Menu is the base from which you start all instrument functions. From it you can choose five different paths: Run, Create, Edit, Util (Utilities), and User. The functions available from each of these paths are summarized in the chart below. Procedures for performing these functions are given in subsequent chapters. Charts showing screen flows from each path on the Main Menu are provided in Appendix C, "Screen Flowcharts."

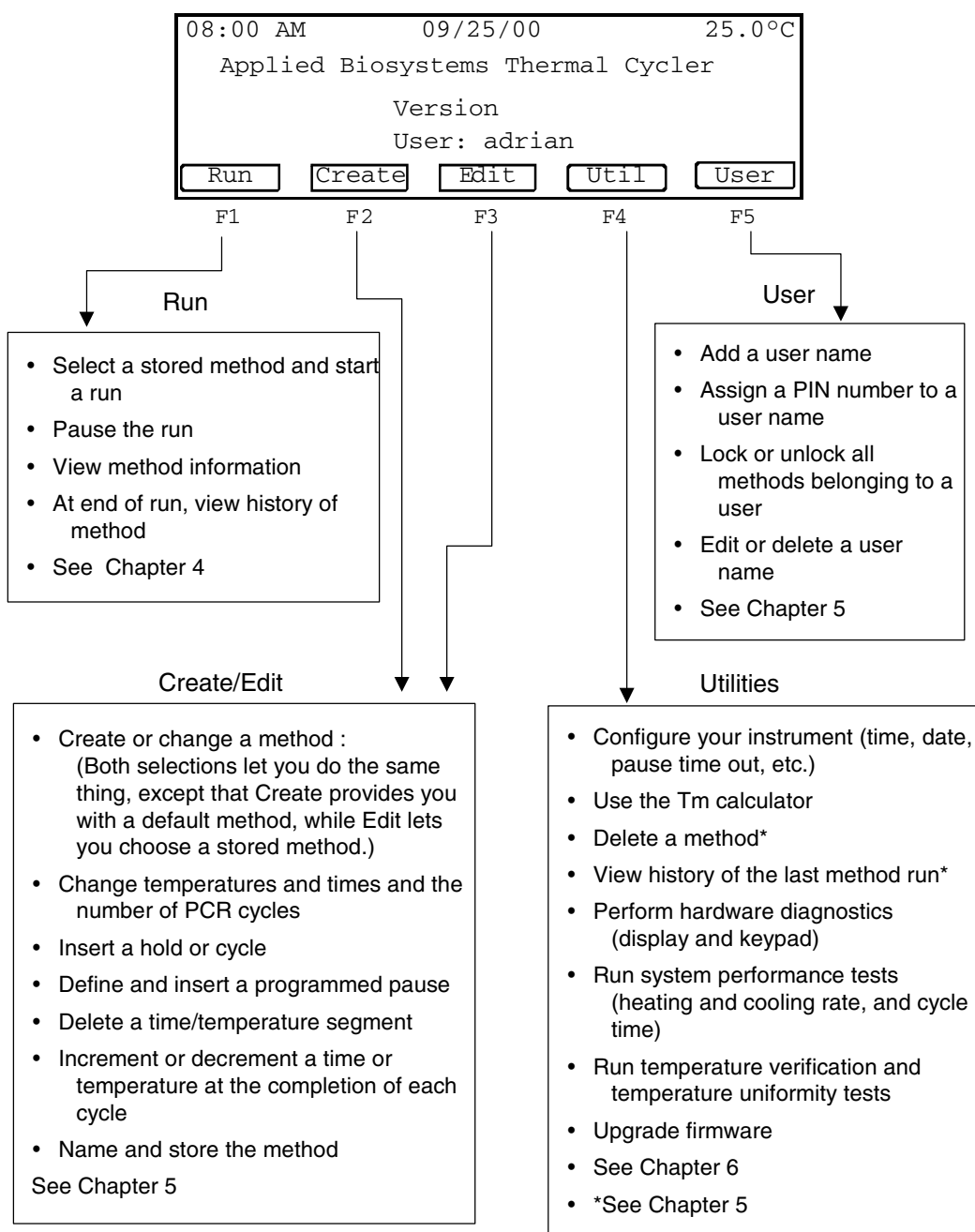

Introducing an Important Screen

Create/Edit Screen One of the features that makes the 2720 Thermal Cycler easy to use is its graphical representation of a method, as shown below on the Create/Edit screen. The graph is the wavy line.

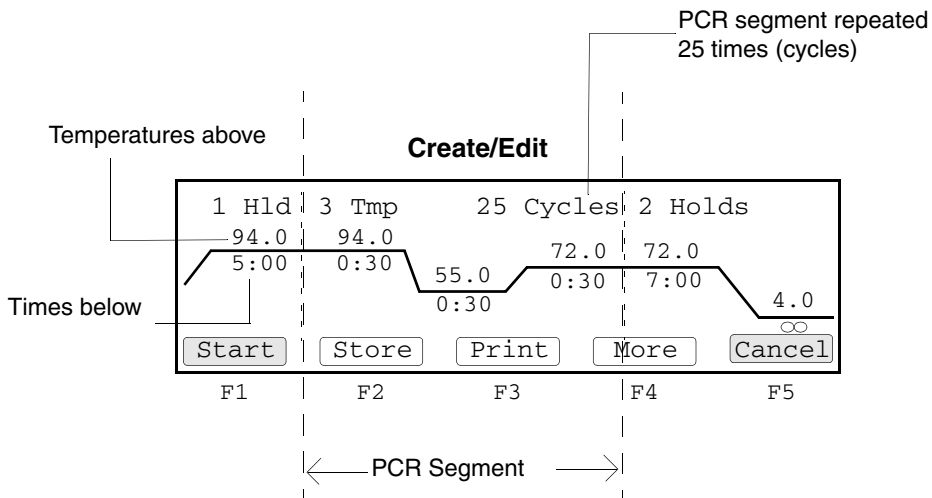

A *method* is a set of instructions in which you specify how the instrument should heat and cool your samples in a PCR thermal profile.

On the Create/Edit screen, temperatures are shown above the graph in degrees Celsius. Hold times in minutes and seconds are shown below the graph. The central portion of the screen, delineated by dashed lines, is the PCR segment. In this example, the PCR segment repeats 25 times. After PCR (in the post-PCR segment), the instrument holds the samples at 72 °C for 7 minutes, then cools to 4 °C and holds the samples at this temperature until you stop the run.

Getting Started

2

Overview

About This Chapter This chapter walks you through some basic procedures to help you learn to use the Applied Biosystems 2720 Thermal Cycler.

The 2720 Thermal Cycler is intuitive and easy to use. We'll start by using the instrument without samples and experiment with the user interface. The following pages describe how to set yourself up as a user and create a method. Other features are introduced later in the chapter.

In This Chapter This chapter contains the following topics:

Topic	See Page
Powering On	2-2
Adding Yourself as a User	2-3
Creating a Method	2-5
Editing Your Method	2-7
Starting and Stopping a Run	2-8
More Features	2-10

Powering On

Procedure To turn on the instrument power:

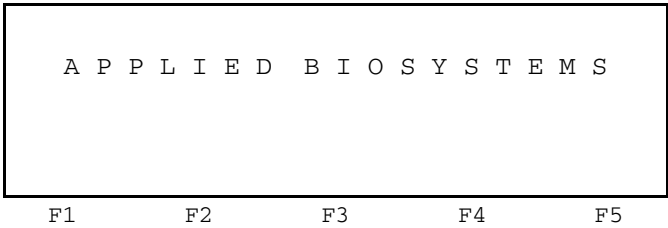
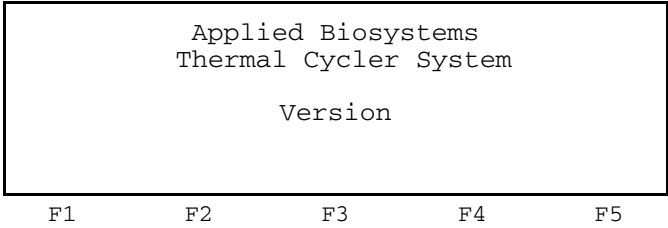
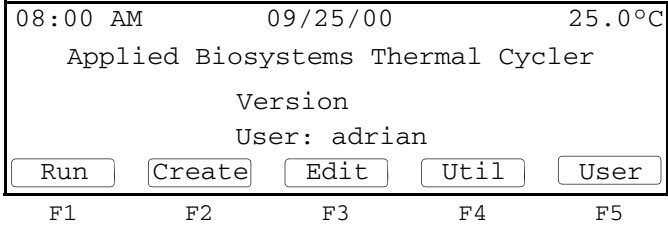
Step	Action
1	<p>Press the power on/off switch at the rear of the instrument. A whirring fan sounds, and the Splash screen appears briefly.</p>  <p>The Startup screen appears.</p> 
2	<p>Wait several seconds for the Main Menu to appear, then you can use any of the functions displayed above the function keys.</p>  <p>Note The Main Menu should appear within a few seconds. If any permanent patterns of lines or bars display on the screen, refer to our Web site.^a</p>

a. <http://www.appliedbiosystems.com/support/contact/>

Adding Yourself as a User

Purpose It's important to add yourself as a user because you will want to keep your methods separate from those belonging to others. Also, the system requires a user name when you store a method.

Procedure To add yourself as a user:

Step	Action																						
1	<p>From the Main Menu press F5 (User). The Select User Name screen appears.</p> <div style="border: 1px solid black; padding: 5px; text-align: center;"> <p>Select User Name</p> <table style="margin: auto;"> <tr> <td style="border: 1px solid gray; padding: 2px;"><<ab>></td> <td>dave</td> <td>jenife</td> <td>murray</td> </tr> <tr> <td>adrian</td> <td>doug</td> <td>mamood</td> <td>nayana</td> </tr> <tr> <td>anna</td> <td>faye</td> <td>mike</td> <td>ngui</td> </tr> </table> <table style="margin: auto; width: 100%;"> <tr> <td style="border: 1px solid gray; padding: 2px;">Accept</td> <td style="border: 1px solid gray; padding: 2px;">New</td> <td style="border: 1px solid gray; padding: 2px;">Edit</td> <td style="border: 1px solid gray; padding: 2px;">Delete</td> <td style="border: 1px solid gray; padding: 2px;">Cancel</td> </tr> <tr> <td style="text-align: center;">F1</td> <td style="text-align: center;">F2</td> <td style="text-align: center;">F3</td> <td style="text-align: center;">F4</td> <td style="text-align: center;">F5</td> </tr> </table> </div>	<<ab>>	dave	jenife	murray	adrian	doug	mamood	nayana	anna	faye	mike	ngui	Accept	New	Edit	Delete	Cancel	F1	F2	F3	F4	F5
<<ab>>	dave	jenife	murray																				
adrian	doug	mamood	nayana																				
anna	faye	mike	ngui																				
Accept	New	Edit	Delete	Cancel																			
F1	F2	F3	F4	F5																			
2	<p>Press F2 (New). The User Name screen appears.</p> <p>Note The blank space after the z is used to insert blank spaces.</p> <div style="border: 1px solid black; padding: 5px;"> <table style="width: 100%;"> <tr> <td style="width: 60%;">User Name</td> <td style="width: 40%; text-align: right;"> abcdefghi jklmnopqrj stuvwxyz . , - + / () := </td> </tr> <tr> <td colspan="2">Use ENTER key to select a character.</td> </tr> <tr> <td style="border: 1px solid gray; padding: 2px;">Accept</td> <td style="border: 1px solid gray; padding: 2px;">Backsp</td> <td style="border: 1px solid gray; padding: 2px;">Cancel</td> </tr> <tr> <td style="text-align: center;">F1</td> <td style="text-align: center;">F2</td> <td style="text-align: center;">F3</td> <td style="text-align: center;">F4</td> <td style="text-align: center;">F5</td> </tr> </table> </div>	User Name	abcdefghi jklmnopqrj stuvwxyz . , - + / () :=	Use ENTER key to select a character.		Accept	Backsp	Cancel	F1	F2	F3	F4	F5										
User Name	abcdefghi jklmnopqrj stuvwxyz . , - + / () :=																						
Use ENTER key to select a character.																							
Accept	Backsp	Cancel																					
F1	F2	F3	F4	F5																			
3	<p>Spell out your name by using the arrow keys to move the highlighter at the right of the screen to the first letter of your name, then press Enter, then highlight the second letter and press Enter, etc. When you have finished entering your name (up to six characters), press F1 (Accept) to save it.</p> <p>The Security Code screen appears.</p> <div style="border: 1px solid black; padding: 5px;"> <p>User Name: adrian PIN number: None Protection: Unlocked</p> <p>Press PIN # to create a #. Then you set protection to Locked to prevent methods from being overwritten or deleted.</p> <table style="width: 100%;"> <tr> <td style="border: 1px solid gray; padding: 2px;">Accept</td> <td style="border: 1px solid gray; padding: 2px;">Name</td> <td style="border: 1px solid gray; padding: 2px;">PIN#</td> <td style="border: 1px solid gray; padding: 2px;">Cancel</td> </tr> <tr> <td style="text-align: center;">F1</td> <td style="text-align: center;">F2</td> <td style="text-align: center;">F3</td> <td style="text-align: center;">F4</td> <td style="text-align: center;">F5</td> </tr> </table> </div>	Accept	Name	PIN#	Cancel	F1	F2	F3	F4	F5													
Accept	Name	PIN#	Cancel																				
F1	F2	F3	F4	F5																			

To add yourself as a user: *(continued)*

Step	Action												
4	<p>Press F5 (Cancel). You can learn about security later.</p> <p>The Select User Name screen appears.</p> <div data-bbox="544 367 1203 562" style="border: 1px solid black; padding: 10px; margin: 10px auto; width: fit-content;"><p style="text-align: center;">Select User Name</p><table data-bbox="625 415 1161 499"><tr><td data-bbox="625 415 730 443"><<ab>></td><td data-bbox="771 415 844 443">dave</td><td data-bbox="893 415 982 443">jenife</td><td data-bbox="1055 415 1161 443">murray</td></tr><tr><td data-bbox="625 443 730 470">adrian</td><td data-bbox="771 443 844 470">doug</td><td data-bbox="893 443 982 470">mamood</td><td data-bbox="1055 443 1161 470">nayana</td></tr><tr><td data-bbox="625 470 730 497">anna</td><td data-bbox="771 470 844 497">faye</td><td data-bbox="893 470 982 497">mike</td><td data-bbox="1055 470 1161 497">ngui</td></tr></table><p data-bbox="548 527 1198 554" style="text-align: center;"><input data-bbox="548 527 657 554" type="button" value="Accept"/> <input data-bbox="683 527 792 554" type="button" value="New"/> <input data-bbox="834 527 927 554" type="button" value="Edit"/> <input data-bbox="954 527 1063 554" type="button" value="Delete"/> <input data-bbox="1089 527 1198 554" type="button" value="Cancel"/></p></div> <p data-bbox="586 569 1161 596" style="text-align: center;">F1 F2 F3 F4 F5</p>	<<ab>>	dave	jenife	murray	adrian	doug	mamood	nayana	anna	faye	mike	ngui
<<ab>>	dave	jenife	murray										
adrian	doug	mamood	nayana										
anna	faye	mike	ngui										
5	With your name highlighted, press F1 (Accept) to return to the Main Menu.												

Creating a Method

Procedure To create a method :

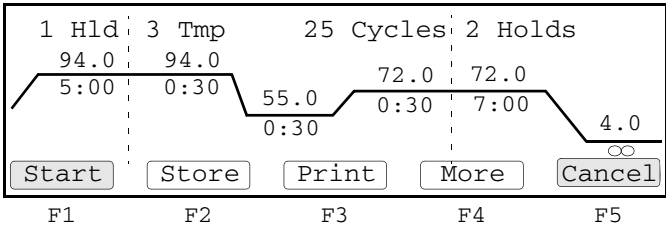
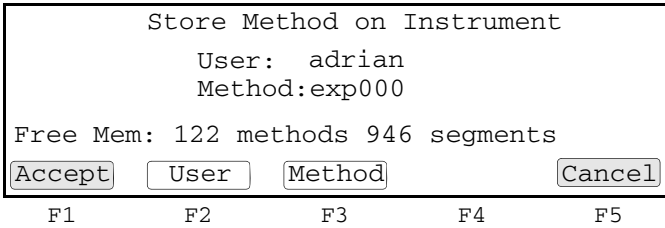
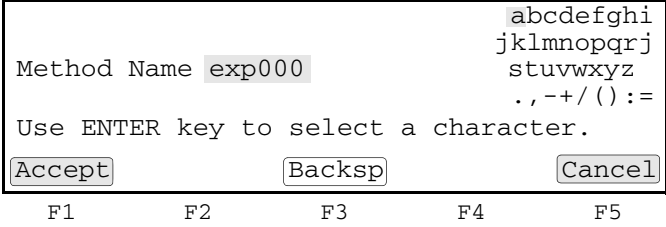
Step	Action
1	<p>From the Main Menu press F2 (Create).</p> <p>The Create/Edit screen appears with a default method displayed.</p> 
2	<p>Use the arrow keys to move the highlighter to a temperature or time on the graph and change the parameter.</p> <p>For example, move the highlighter to the 5:00 time at the left of the screen in the pre-PCR portion. Press 5 3 0 then press Enter, for 5:30.</p>
3	<p>Make a change to the top line.</p> <p>For example, use the arrow keys to move the highlighter to the 1 in the upper left corner of the screen. Press 2, then Enter. Notice that you've added a hold (another time and temperature segment) to the graph.</p>
4	<p>Press F2 (Store) to save the method.</p> <p>The Store Method on Instrument screen appears.</p>  <p>The system has given the method a default name of "exp000". We will use a different name.</p>
5	<p>Press F3 (Method).</p> <p>The Method Name screen appears.</p> 
6	<p>Press the CE key to clear the field. Then spell out test01 by highlighting each letter and pressing Enter after each one.</p>

To create a method *(continued)*:

Step	Action
7	Press F1 (Accept). The Store Method on Instrument screen appears again with "test01" as the method name. On the 2720 Thermal Cycler, a method has a method name, and it is associated with a particular user.
8	Press F1 (Accept). The system saves your method and returns to the Main Menu.

Editing Your Method

Procedure To edit the method :

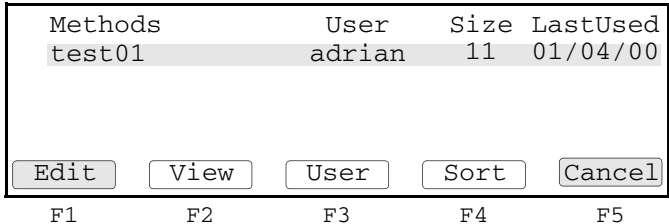
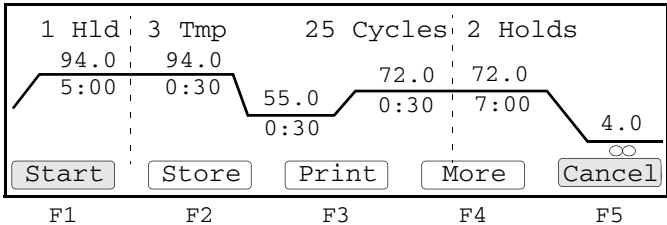
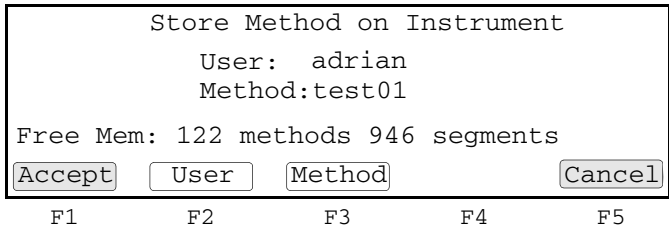
Step	Action
1	<p>From the Main Menu press F2 (Edit).</p> <p>The Stored Methods screen appears. You have only one method, so it's already highlighted. If there were more than one method listed, you would highlight it to select it.</p> 
2	<p>Press F1 (Edit).</p> <p>The Create/Edit screen appears. This is the same screen you accessed from the Create path from the Main Menu. The Create and Edit paths allow you to do the same things once you reach this screen.</p> 
3	<p>Move the highlighter to any parameter and change it.</p> <p>For example, move the highlighter to 94.0 in the Pre-PCR segment and press 9 0 0 then Enter for 90.0 °C.</p>
4	<p>Press F2 (Store).</p> <p>The Store Method on Instrument screen appears.</p> 
5	<p>Press F1 (Accept) to save the method under the same name ("test01").</p> <p>The Main Menu is displayed.</p>

Starting and Stopping a Run

Before You Begin Let's assume that we've loaded our samples properly and we're ready to start a run.

Procedure To start, then stop a run :

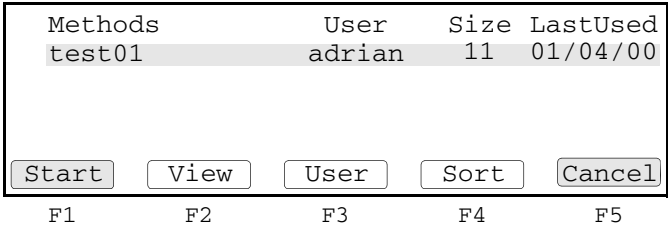
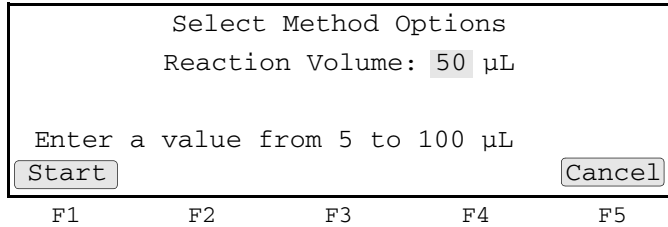
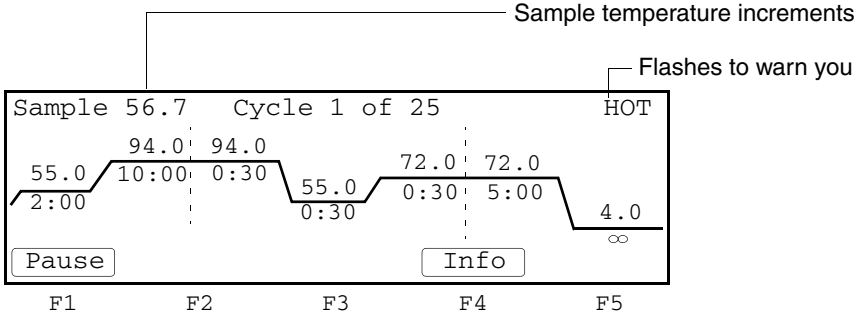
Step	Action
1	<p>From the Main menu press F1 (Run). The Stored Methods screen appears.</p>  <p>Since we have only one method ("test01"), it's already highlighted (selected).</p>
2	<p>Press F1 (Start). The Select Method Options screen appears.</p> 
3	<p>Change the reaction volume to 40, then press F1 (Start). The Run Time screen appears.</p> 

To start, then stop a run (continued):

Step	Action
4	<p>Press the Stop key.</p> <p>The Confirm Stop screen appears.</p> <div data-bbox="597 365 1256 590" style="border: 1px solid black; padding: 5px;"> <pre> Sample 50.1 Confirm Stop HOT Press STOP to abort. Press Resume to continue. Resume F1 F2 F3 F4 F5 </pre> </div>
5	<p>Press the Stop key again to abort the run.</p> <p>The End of Run screen appears.</p> <div data-bbox="597 709 1256 905" style="border: 1px solid black; padding: 5px;"> <pre> 11:30 AM End of Run 25.1°C Method: test01 Run aborted at 11:30:05 AM 01/04/00. Length of run is 01:34:25. Hist Exit F1 F2 F3 F4 F5 </pre> </div>
6	<p>Press F5 (Exit) to return to the Main Menu.</p>

More Features

Overview Now you know the basics of operating the 2720 Thermal Cycler. The system provides additional features. Some things you might try are discussed below.

Navigating from the Main Menu Explore paths from the Main Menu to find out what's available on the system. Refer to the charts in Appendix C, "Screen Flowcharts."

Looking at Methods Look at a list of all methods, sort the list, and view individual methods:

- ◆ List all methods on the instrument. Access the Stored Methods screen by pressing F1 (Run) or F5 (Edit) on the Main Menu. Then press F3 (User) to reach the Select User Name screen. Press F2 (All) to display the Stored Methods screen listing all methods on the system. Use the down and up arrow keys to scroll through the list.
- ◆ Sort the methods by pressing F4 (Sort).
- ◆ View any method by pressing F2 (View).
- ◆ Select yourself as the user again by pressing F3 (User), highlighting your name, then pressing F1 (Accept).

Creating Your Method Create your most commonly used method. If your method is more complex than the one we edited earlier, you can change it using one of the following:

- ◆ Insert a hold or cycle
- ◆ Define and insert a programmed pause
- ◆ Automatically increment or decrement a time or temperature at the completion of each cycle
- ◆ Delete a segment

These functions can be accessed from the Modify screen, which is reached by pressing F4 (More) on the Create/Edit screen. See the Create/Edit chart on page C-4.

Accessing More Run Screens Start a run to see what else is available from the Run path from the Main Menu. After you start a run, the Run Time screen, which shows a graph of your method, appears. From there you can do the following:

- ◆ View the Method Information screen by pressing F4 (Info)
 - ◆ Briefly pause, then resume a run by pressing F1 (Pause)
 - ◆ Stop the run by pressing the Stop key twice. From the End of Run screen, press F1 (Hist) to view the History File.
-

Protecting Your Methods Consider using a PIN number and locking your methods.

Each user of the 2720 Thermal Cycler should have his/her own user name. That way, each person's methods can be kept separate. When you add a user name, the system prompts you to create a PIN number. If you have a PIN number, no one can change your user name. Once you have created a PIN number for yourself and confirmed it, the system allows you to lock your methods. By default they are unlocked. Locking

safeguards **all** your methods. Only someone who knows your PIN number can overwrite or delete any of your methods.

When you attempt to change and store one of your methods after locking them, the system protects you by prompting you to enter your PIN number before it will allow you to store the method. This is a small inconvenience for the benefit it provides. When you are creating a new method, the system does not prompt you for your PIN number.

If you decide you don't want your methods locked, you can easily change them back to unlocked.

To learn how to protect your methods, see the User chart on page C-5.

Runs

3

Overview

About This Chapter This chapter tells what you need to know to run your samples: the MicroAmp® disposables you use to hold your samples, how to load samples, and how to start and stop a run.

In This Chapter This chapter contains the following topics:

Topic	See Page
Using Disposables	3-2
Loading Samples	3-5
Starting a Run	3-7
Pausing or Stopping a Run	3-9
Reviewing the History of a Run	3-11
When a Run Completes	3-13

Using Disposables

Introduction The following section describes the possible tube configurations, choosing a tube configuration, and sample tray and plate configurations.

IMPORTANT The Tray or the Tray/Retainer are essential for the operation of the Applied Biosystems 2720 Thermal Cycler.

Tube Configurations The MicroAmp® disposables you can use to hold your PCR samples include four different types of tube configurations, as shown in the figure below.

MicroAmp® Reaction
Tubes with Caps



MicroAmp® Reaction
Tubes with
MicroAmp® Cap
(8-Strip)

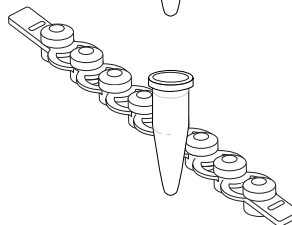

MicroAmp® Reaction
Tubes with Full Plate
Cover

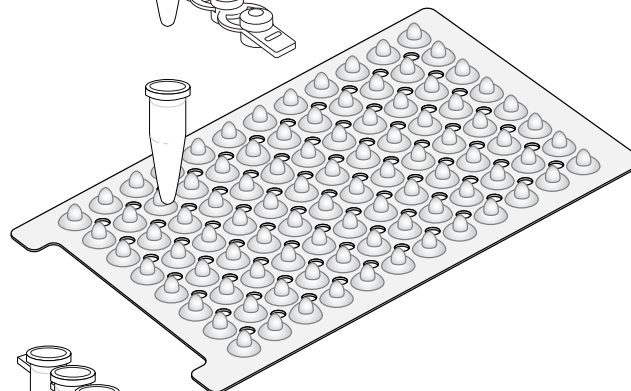

MicroAmp® 8-Strip
Reaction Tubes



Choosing a Tube Configuration

Use the table below to help you choose a tube configuration.

You can prepare samples for the instrument using any of the four tube configurations. All the tube configurations, except the MicroAmp® Reaction Tubes with Caps use the MicroAmp® 96-Well Tray/Retainer.

If you want to use...	Choose a tube configuration that uses the...
eight or more samples	MicroAmp® 96-Well Tray/Retainer.
<ul style="list-style-type: none"> ◆ Only a few samples, or ◆ Want to remove single tubes from the sample block without removing the caps from all the tubes 	MicroAmp® Tray for tubes with attached caps.

Sample Tray and Plate Configurations

The following table lists the possible sample tray and plate configurations. The MicroAmp® Splash-Free Support Base shown below is used when loading samples but should not be placed in the sample block.

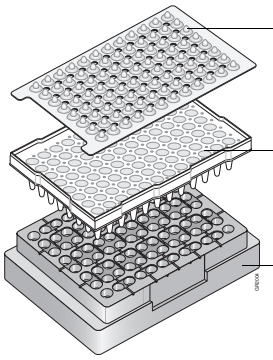
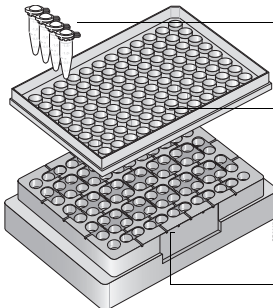
With this vessel...	Use...	As Shown
MicroAmp® Optical 96-Well Reaction Plate	MicroAmp 96-Well Full Plate Cover	 <ul style="list-style-type: none"> MicroAmp 96-Well Full Plate Cover MicroAmp Optical 96-Well Reaction Plate MicroAmp Splash-Free Support Base
	MicroAmp Caps, 8 Caps/Strip	 <ul style="list-style-type: none"> MicroAmp Caps, 8-Strip MicroAmp Optical 96-Well Reaction Plate MicroAmp Splash-Free Support Base
MicroAmp Reaction Tubes with Caps	MicroAmp® 96-Well Tray for Tubes with Caps	 <ul style="list-style-type: none"> MicroAmp Reaction Tubes with Caps MicroAmp 96-Well Tray for Tubes with Caps MicroAmp Splash-Free Support Base

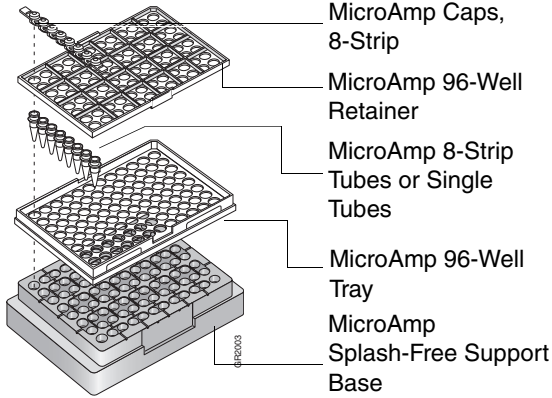
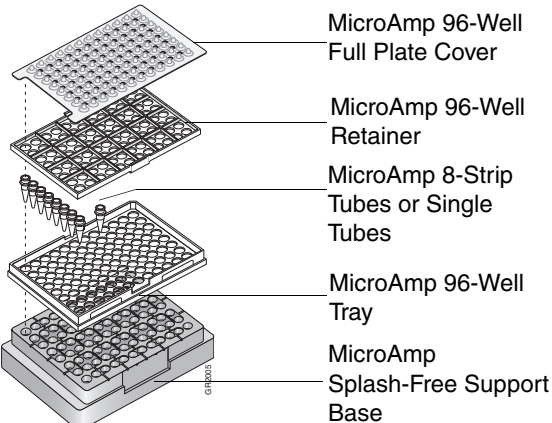
With this vessel...	Use...	As Shown
MicroAmp 8 Strip Tubes or Single Tubes	MicroAmp 96-Well Tray/Retainer	
	MicroAmp 96-Well Full Plate Cover	

Part Numbers You can order disposables for the system 2720 from Applied Biosystems by part number.

Disposable	Part Number
MicroAmp 96-Well Tray/Retainer Sets	403081
MicroAmp Multipurpose Tool	413950
MicroAmp Splash-Free Support Base	4312063
MicroAmp Reaction Tubes	N801-0533
MicroAmp Caps, 12 Caps/Strip	N801-0534
MicroAmp Caps, 8 Caps/Strip	N801-0535
MicroAmp Reaction Tubes with Caps	N801-0540
MicroAmp 96-Well Tray for Tubes with Caps	N801-0541
MicroAmp 96-Well Full Plate Cover	N801-0550
MicroAmp Optical 96-Well Reaction Plate	N801-0560
MicroAmp 8-Strip Reaction Tubes	N801-0580
MicroAmp Centrifuge Adapter	N801-3822

Loading Samples

Procedures for Loading Samples

The following procedures describe how to load samples for:

- ◆ Tubes with attached caps.
- ◆ 96-well reaction plate.
- ◆ 96-well tray/retainer assembly.

Note Do not use mineral oil or glycerine in the sample block or as a vapor barrier over the PCR reaction mixture in the tubes. The MicroAmp Reaction Tubes fit tightly in the wells and a heated cover exerts an even pressure on all tubes and eliminates condensation on the tubes.

Loading Tubes with Attached Caps

To load tubes with attached caps:

Step	Action
1	Set the 96-well tray on a splash-free support base.
2	Place the reaction tubes in the tray.
3	Pipette the samples into the reaction tubes.
4	Cap the tubes. See "Placing the Sample Tray or Plate onto the Sample Block" on page 3-6.

Loading the 96-Well Reaction Plate

To load the 96-well reaction plate:

Step	Action
1	Place the reaction plate on the splash-free support base.
2	Pipette the samples into the sample wells.
3	Cap the tubes using either the MicroAmp 96-Well Full Plate Cover or the MicroAmp Caps, 8 Caps/Strip. See "Placing the Sample Tray or Plate onto the Sample Block" on page 3-6.

Loading the 96-Well Tray/Retainer

To load the 96-well tray/retainer:

Step	Action
1	Place the tray on the splash-free support base.
2	Load tubes onto the tray, either using single tubes or using the 8-strip tubes.
3	Place retainer over the tubes.
4	Pipette the sample into the tubes.
5	Cap the tubes using either the MicroAmp 96-Well Full Plate Cover or the MicroAmp Caps, 8 Caps/Strip. See "Placing the Sample Tray or Plate onto the Sample Block" on page 3-6.

Placing the Sample Tray or Plate onto the Sample Block

The steps for placing the sample tray in the block are the same for a sample tray/retainer, a sample tray without a retainer, for tubes with attached caps, or for the 96-well plate.

To place the sample tray in the block:

Step	Action
1	<p>Lift the sample tray from the splash-free support base and place it in the sample block.</p> <p>Place the MicroAmp Tray or Plate onto the sample block so that the well numbered A1 is located at the upper left corner of the tray, as shown below. This orients the tray for proper fit.</p> <div data-bbox="544 619 933 913" style="text-align: center;"> <p>A1</p> </div> <p>IMPORTANT Do not place the base in the sample block.</p>
2	Pull the lever down to engage the heated cover and the sample tray.

Removing the Samples

Sample caps may pop off if the cover is opened when the block temperature is above 27 °C.

Starting a Run

Procedure To start a run:

Step	Action																				
1	Load your samples, as described in "Loading Samples" on page 3-5. Note Disposables must be used.																				
2	If the instrument power is not on, press the power-on button at the back of the instrument.																				
3	From the Main Menu press F1 (Run). The Stored Methods screen appears. <div style="border: 1px solid black; padding: 5px; margin: 10px 0;"> <table style="width: 100%; border-collapse: collapse;"> <thead> <tr> <th style="text-align: left;">Methods</th> <th style="text-align: left;">User</th> <th style="text-align: left;">Size</th> <th style="text-align: left;">LastUsed</th> </tr> </thead> <tbody> <tr> <td>appl01</td> <td>adrian</td> <td>11</td> <td>03/04/00</td> </tr> <tr> <td>exp000</td> <td>adrian</td> <td>10</td> <td>02/22/00</td> </tr> <tr> <td>exp001</td> <td>adrian</td> <td>12</td> <td>02/10/00</td> </tr> <tr> <td>exp002</td> <td>adrian</td> <td>13</td> <td>02/02/00</td> </tr> </tbody> </table> <div style="display: flex; justify-content: space-around; margin-top: 5px;"> Start View User Sort Cancel </div> </div> <p style="text-align: center; margin-top: 5px;"> F1 F2 F3 F4 F5 </p>	Methods	User	Size	LastUsed	appl01	adrian	11	03/04/00	exp000	adrian	10	02/22/00	exp001	adrian	12	02/10/00	exp002	adrian	13	02/02/00
Methods	User	Size	LastUsed																		
appl01	adrian	11	03/04/00																		
exp000	adrian	10	02/22/00																		
exp001	adrian	12	02/10/00																		
exp002	adrian	13	02/02/00																		
4	Select a method by highlighting one of the displayed methods. If the method you want is not displayed, see "Handling Methods" on page 4-18.																				
5	Press F1 (Start). The Select Method Options screen appears. <div style="border: 1px solid black; padding: 10px; margin: 10px 0;"> <p style="text-align: center;">Select Method Options</p> <p style="text-align: center;">Reaction Volume: 50 µL</p> <p style="text-align: center;">Enter a value from 5 to 100 µL</p> <div style="display: flex; justify-content: space-between; margin-top: 10px;"> Start Cancel </div> </div> <p style="text-align: center; margin-top: 5px;"> F1 F2 F3 F4 F5 </p>																				
6	Enter the reaction volume, then press F1 (Start). If the temperature of the heated cover is less than 103 °C, the screen shown below appears. <div style="border: 1px solid black; padding: 10px; margin: 10px 0;"> <p style="text-align: center;">Please wait. Cover is heating</p> <p style="text-align: center;">Current temperature: 65°C</p> <p style="text-align: center;">The run will begin when the heated cover reaches 103°C.</p> <div style="text-align: right; margin-top: 10px;"> Cancel </div> </div> <p style="text-align: center; margin-top: 5px;"> F1 F2 F3 F4 F5 </p>																				

To start a run: (continued)

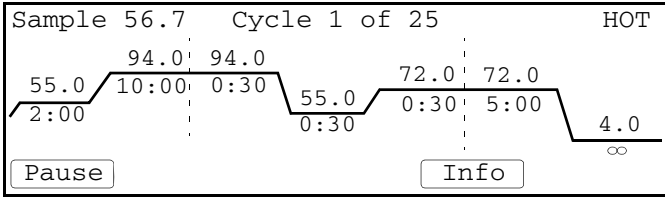
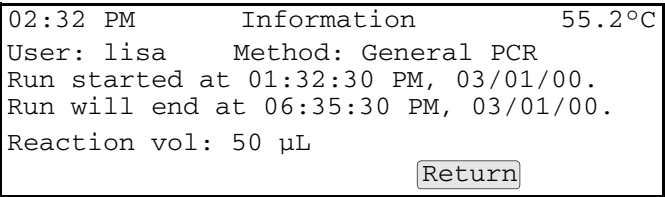
Step	Action
7	<p>Wait for the heated cover to reach 103 °C.</p> <p>The Run Time screen displays and the method you selected starts running.</p>  <p>Sample 56.7 Cycle 1 of 25 HOT</p> <p>55.0 94.0 94.0 72.0 72.0</p> <p>2:00 10:00 0:30 0:30 5:00</p> <p>55.0 4.0</p> <p>∞</p> <p>Pause Info</p> <p>F1 F2 F3 F4 F5</p>
8	<p><i>Optional.</i> To find out when the run will end, press F4 (Info).</p> <p>The Method Information screen appears.</p>  <p>02:32 PM Information 55.2°C</p> <p>User: lisa Method: General PCR</p> <p>Run started at 01:32:30 PM, 03/01/00.</p> <p>Run will end at 06:35:30 PM, 03/01/00.</p> <p>Reaction vol: 50 µL</p> <p>Return</p> <p>F1 F2 F3 F4 F5</p> <p>When you are through viewing this screen, press F4 (Return) to redisplay the Run Time screen.</p>

Pausing or Stopping a Run

Overview This section describes how you can pause a run or stop it completely.

Pausing a Run During a run, the Run Time screen is displayed.

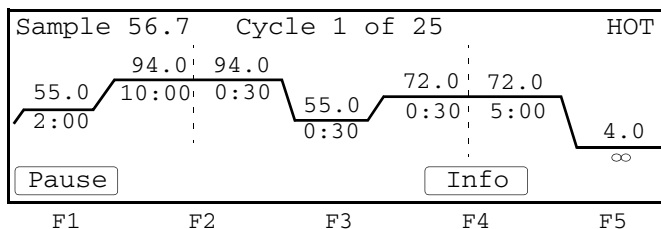

From this screen you can pause a run for a prespecified length of time and then resume it. For example, you might pause a run in order to add a reagent.

Note Do not touch the sample block or the bottom of the heated cover during a pause.

To pause a run:

Step	Action
1	<p>With the Run Time screen displayed, press F1 (Pause).</p> <p>The Pause screen appears.</p> <p>Buttons: Resume</p> <p>Text: Paused. Will resume in mm:ss</p> <p>Function Keys: F1, F2, F3, F4, F5</p>
2	To resume the run, press F1 (Resume) to return to the Run Time screen.

During a pause, the samples remain at the temperature they were paused at. The instrument resumes the run automatically if the pause time out expires before you press F1 to resume the run.

By default the pause time out period is 10 minutes. To specify a different time, see “Configuring the Instrument” on page 5-2.

Stopping a Run The Stop key can be used to stop a run.

To stop a run before it completes:

Step	Action
1	<p>Press the Stop key.</p> <p>The Confirm Stop screen appears.</p> <div data-bbox="540 464 1203 657" style="border: 1px solid black; padding: 5px;"><pre>Sample 50.1 Confirm Stop HOT Press STOP to abort. Press Resume to continue. Resume</pre></div> <p style="text-align: center;">F1 F2 F3 F4 F5</p>
2	<p>Press the Stop key again to stop the run.</p> <p>The run stops and the End of Run screen appears.</p> <div data-bbox="540 789 1203 982" style="border: 1px solid black; padding: 5px;"><pre>11:30 AM End of Run 25.1°C Method:exp001 Run aborted at 11:30:05 AM 02/01/00. Length of run is 01:34:25. Hist</pre></div> <p style="text-align: center;">F1 F2 F3 F4 F5</p> <p>If any errors occur during a run, the following message appears: "Exception occurred, check history file." Press F1 (Hist) to review the history file. For more information, see the following section.</p>
3	<p>Press F5 (Exit) to return to the Main Menu.</p>

In the above procedure, after the Stop key was pressed the first time, the run could have been resumed within the prespecified time (default is 10 minutes). This time is the same pause time out discussed in "Pausing a Run" on page 3-9. The instrument aborts the run automatically if the pause time out expires before you press F1 to resume the run.

Reviewing the History of a Run

Reviewing the History

From the End of Run screen or the Utilities path, you can display the History File screen, which provides information about the run that just ended. This information includes the events and errors that occurred during the run. The instrument stores this information until it is overwritten by the next method used.

To review the history:

Step	Action
1	Access the History File screen by: <ul style="list-style-type: none"> ◆ Pressing F1 (Hist) from the End of Run screen, or ◆ Pressing F4 (Util) from the Main Menu, then F4 (More) from the Utilities 1 screen, then F3 (Hist) from the Utilities 2 screen. <div style="border: 1px solid black; padding: 5px; margin: 10px 0;"> <pre>History of method exp002 User: adrian Reaction volume: 50 µL Run started at 02:30:45 PM, 02/01/00. Run aborted at 02:50:42 PM, 02/01/00. Length of run 00:19:57 No exceptions [PageDn] [Print] [Return]</pre> </div> <p style="text-align: center;">F1 F2 F3 F4 F5</p>
2	Press F3 (Page Dn) or F2 (Page Up) to scroll through the file.
3	<i>Optional.</i> Press F4 (Print) to print the record.

History Formats

The following table lists the history line formats.

Pre-PCR hold	<Exception> in Pre-PCR xx Setpt xx
PCR segment	<Exception> in Cycle xx Setpt xx Repxx
Any other hold	<Exception> in Hold xx Setpt xx

History File Records The following table lists the history file record, a description of the record, and the type of record.

Record	Description	Type
History of method xxxxxxxxxxxxxxxx User xxxxxx Reaction volume xxx µL Run started at hh:mm:ss am mm/dd/yy Run ended at hh:mm:ss am mm/dd/yy Length of run hh:mm:ss RampSpeed: 9600	This header record is always created.	Report
Power failure in Cycle xx at Setpt xx. Power failed at hh:mm:ss am for hh:mm:ss. Run resumed at hh:mm:ss am	There was a power failure during a specified point in a cycle. The message, for >18, indicates that the power was off for more than 18 hours.	Report
Drift error in Cycle xx Setpt xx Repxx. Temperature drifted x.x°C from setpt	Block drift error. The block has drifted ± 2 °C from set point during the hold segment of a run.	Report
Cover error in Cycle xx Setpt xx Repxx. Heated cover at xx.x°C	Heated cover drift error. The cover has drifted ± 5 °C from 105 °C anytime during the run.	Report
Sensor error in Cycle xx Setpt xx Repxx. Block sensor failure.	Block sensor failure.	Fatal error. Access our Web site. ^a
Sensor error in Cycle xx Setpt xx Repxx. Cover sensor failure.	Heated cover sensor failure.	Fatal error. Access our Web site. ^a
Setpt error in Cycle xx Setpt xx Repxx. Could not reach xx.x in hh:mm:ss	This setpoint error is only logged for setpoints above 15 °C. The limit is 5 times the normal ramping time.	Fatal error. Access our Web site. ^a
Program pause in Cycle xx Setpt xx Rep xxx Method paused at xx °C for hh:mm:ss	A programmed pause was encountered.	Report
Manual pause in Cycle xx Setpt xx Rep xxx Method paused at xx °C for hh:mm:ss	You paused the run.	Report

a. <http://www.appliedbiosystems.com/support/contact>

When a Run Completes

End of Run Screen When a run ends, the End of Run screen appears. However, if your method has an indefinite hold of 4 °C (for example), you must first press the Stop key to display the screen shown below.

```
11:30 AM      End of Run      25.1°C
Method: General PCR
Run completed at 11:30:05 AM, 02/01/00.
Length of run is 01:34:25.

Hist          Exit

F1           F2           F3           F4           F5
```

If you created a new method but have not stored it, when F5 (Exit) is pressed, the Method Not Stored screen displays to give you the opportunity to save the method before returning to the Main Menu.

Method Not Stored Screen If you attempt to exit the End of Run screen before storing a new method, the Method Not Stored screen appears.

```
Method Not Stored

Press Store to save the method.
Press Exit to delete the method.

Store        Exit

F1           F2           F3           F4           F5
```

If you want to store the method, press F2 (Store). For more information about naming and storing a method, see “Creating a Method” on page 4-6.

4

Methods and Users

Overview

About This Chapter This chapter provides procedures for creating and editing a method whether it is simple or more complex. Procedures for adding and handling user names are also included.

In This Chapter This chapter contains the following topics:

Topic	See Page
Adding, Changing, or Deleting a User Name	4-2
Creating a Method	4-6
Changing a Method Using Advanced Features	4-9
Handling Methods	4-18

Adding, Changing, or Deleting a User Name

Introduction On the Applied Biosystems 2720 Thermal Cycler, methods are stored by both method name and user name. It's important to have your own user name to keep your methods separate from those belonging to other users. Even if you are the only user of the system, you still need a user name.

A user name can be added, as well as changed or deleted. You can protect your user name by having a PIN number. When a PIN number has been created, only the person who knows the PIN number can change the user name. Additionally, once you have PIN, the system allows you to lock your methods. When your methods are locked, only the person who knows the PIN number can overwrite or delete them. Having a PIN number is optional, as is locking your methods.

Adding a User Name To add a user:

Step	Action												
1	<p>From the Main Menu, press F5 (User).</p> <p>The Select User Name screen appears.</p> <div style="border: 1px solid black; padding: 10px; text-align: center;"> <p>Select User Name</p> <table style="margin: auto;"> <tr> <td><<ab>></td> <td>dave</td> <td>jenife</td> <td>murray</td> </tr> <tr> <td>adrian</td> <td>doug</td> <td>mamood</td> <td>nayana</td> </tr> <tr> <td>anna</td> <td>faye</td> <td>mike</td> <td>ngui</td> </tr> </table> <p> <input type="button" value="Accept"/> <input type="button" value="New"/> <input type="button" value="Edit"/> <input type="button" value="Delete"/> <input type="button" value="Cancel"/> </p> <p style="font-size: small;">F1 F2 F3 F4 F5</p> </div>	<<ab>>	dave	jenife	murray	adrian	doug	mamood	nayana	anna	faye	mike	ngui
<<ab>>	dave	jenife	murray										
adrian	doug	mamood	nayana										
anna	faye	mike	ngui										
2	<p>Press F2 (New).</p> <p>The User Name screen appears.</p> <p>Note The blank space after the z is used to insert blank spaces.</p> <div style="border: 1px solid black; padding: 10px;"> <table style="width: 100%; border-collapse: collapse;"> <tr> <td style="width: 60%;"></td> <td style="width: 40%; text-align: right;"> abcdefghi jklmnopqrj stuvwxyz ., -+ / () := </td> </tr> <tr> <td>User Name <input style="width: 100px;" type="text"/></td> <td></td> </tr> <tr> <td colspan="2">Use ENTER key to select a character.</td> </tr> <tr> <td> <input type="button" value="Accept"/> </td> <td> <input type="button" value="Backsp"/> </td> </tr> <tr> <td></td> <td style="text-align: right;"> <input type="button" value="Cancel"/> </td> </tr> <tr> <td style="font-size: small;">F1</td> <td style="font-size: small;">F2 F3 F4 F5</td> </tr> </table> </div>		abcdefghi jklmnopqrj stuvwxyz ., -+ / () :=	User Name <input style="width: 100px;" type="text"/>		Use ENTER key to select a character.		<input type="button" value="Accept"/>	<input type="button" value="Backsp"/>		<input type="button" value="Cancel"/>	F1	F2 F3 F4 F5
	abcdefghi jklmnopqrj stuvwxyz ., -+ / () :=												
User Name <input style="width: 100px;" type="text"/>													
Use ENTER key to select a character.													
<input type="button" value="Accept"/>	<input type="button" value="Backsp"/>												
	<input type="button" value="Cancel"/>												
F1	F2 F3 F4 F5												

To add a user: (continued)

Step	Action
3	<p>Spell the name by using the arrow keys to highlight the first letter of the name, then press Enter, then highlight the second letter, then press Enter, etc.</p> <p>When you have finished spelling the name (up to six characters), press F1 (Accept). The Security Code screen appears.</p> <div data-bbox="591 453 1252 646" style="border: 1px solid black; padding: 5px;"> <pre>User Name: hank PIN number: None Protection: Unlocked Press PIN # to create a #. Then you set protection to Locked to prevent methods from being overwritten or deleted.</pre> <p style="text-align: center;"> <input type="button" value="Accept"/> <input type="button" value="Name"/> <input type="button" value="PIN#"/> <input type="button" value="Cancel"/> </p> </div> <p style="text-align: center;"> F1 F2 F3 F4 F5 </p> <p>If you want to add a PIN number, continue with the next step. If not, press F5 (Cancel) to return to the Select User Name screen, which now shows your newly added user name.</p>
4	<p>Press F3 (PIN#).</p> <p>The Create a PIN Number screen appears.</p> <div data-bbox="596 884 1256 1077" style="border: 1px solid black; padding: 5px;"> <pre style="text-align: center;">Create a PIN Number Your PIN number protects the access to your user name and protection level Enter a PIN number. New PIN #: XXXX</pre> <p style="text-align: center;"> <input type="button" value="Accept"/> <input type="button" value="Cancel"/> </p> </div> <p style="text-align: center;"> F1 F2 F3 F4 F5 </p>
5	<p>Use the numeric keys to type a 4-digit PIN number, then press F1 (Accept).</p> <p>The Confirm PIN Number screen appears.</p> <div data-bbox="596 1218 1256 1411" style="border: 1px solid black; padding: 5px;"> <pre style="text-align: center;">Confirm PIN Number Your PIN number protects the access to your user name and protection level Enter a PIN number again. PIN #: XXXX Press Accept to confirm your PIN #.</pre> <p style="text-align: center;"> <input type="button" value="Accept"/> <input type="button" value="Cancel"/> </p> </div> <p style="text-align: center;"> F1 F2 F3 F4 F5 </p>
6	<p>Retype the same 4-digit PIN number, then press F1 (Accept).</p> <p>The Protection Status screen appears.</p> <div data-bbox="596 1560 1256 1753" style="border: 1px solid black; padding: 5px;"> <pre>Username: hank PIN number: XXXX Protection: Unlocked Press PIN # to create a #. Then you set protection to Locked to prevent methods from being overwritten or deleted.</pre> <p style="text-align: center;"> <input type="button" value="Accept"/> <input type="button" value="Name"/> <input type="button" value="PIN#"/> <input type="button" value="Lock"/> <input type="button" value="Cancel"/> </p> </div> <p style="text-align: center;"> F1 F2 F3 F4 F5 </p>

To add a user: (continued)

Step	Action
7	<p><i>Optional.</i> Notice that the Protection field is set to Unlocked.</p> <p>Press F4 (Lock) to lock your methods. This toggles between a Locked and Unlocked state.</p> <p>Press F1 (Accept) to accept the protection status displayed and return to the Select User Name screen.</p>
8	Press F1 (Accept) to return to the Main Menu.

Changing a User Name

A user name can be changed. However, if a PIN number was assigned to the name, only the person who knows the PIN number can change the name.

To change a user name:

Step	Action															
1	<p>From the Main Menu, press F5 (User).</p> <p>The Select User Name screen appears.</p> <div style="border: 1px solid black; padding: 10px; margin: 10px 0;"> <p style="text-align: center;">Select User Name</p> <table style="width: 100%; border-collapse: collapse;"> <tr> <td style="width: 15%;"><code><<ab>></code></td> <td style="width: 20%;">dave</td> <td style="width: 20%;">jenife</td> <td style="width: 20%;">murray</td> <td style="width: 25%;"></td> </tr> <tr> <td>adrian</td> <td>doug</td> <td>mamood</td> <td>nayana</td> <td></td> </tr> <tr> <td>anna</td> <td>faye</td> <td>mike</td> <td>ngui</td> <td></td> </tr> </table> <p style="text-align: center;"> <input type="button" value="Accept"/> <input type="button" value="New"/> <input type="button" value="Edit"/> <input type="button" value="Delete"/> <input type="button" value="Cancel"/> </p> <p style="text-align: center;"> F1 F2 F3 F4 F5 </p> </div>	<code><<ab>></code>	dave	jenife	murray		adrian	doug	mamood	nayana		anna	faye	mike	ngui	
<code><<ab>></code>	dave	jenife	murray													
adrian	doug	mamood	nayana													
anna	faye	mike	ngui													
2	Highlight the user name you want, then press F3 (Edit).															
3	<p><i>Optional.</i> If the system has a PIN number for this user, the Security Check screen appears.</p> <div style="border: 1px solid black; padding: 10px; margin: 10px 0;"> <p style="text-align: center;">Security Check</p> <p>To perform this action, you must enter your PIN #:</p> <p>Your PIN #: <input style="width: 50px;" type="text"/></p> <p style="text-align: center;"> <input type="button" value="Accept"/> <input type="button" value="Cancel"/> </p> <p style="text-align: center;"> F1 F2 F3 F4 F5 </p> </div> <p>Type the PIN number, then press F1 (Accept).</p>															

To change a user name: *(continued)*

Step	Action
4	<p>When the following screen appears, function key F4 may or may not be active, depending on whether this user has a PIN number.</p> <pre> Username: hank PIN number: XXXX Protection: Unlocked Press PIN # to create a #. Then you set protection to Locked to prevent methods from being overwritten or deleted. Accept Name PIN# Lock Cancel F1 F2 F3 F4 F5 </pre> <p>Press F2 (Name).</p> <p>The User Name screen appears.</p> <pre> User Name [] abcdefghi jklmnopqrj stuvwxyz ., -+ / () := Use ENTER key to select a character. Accept Backsp Cancel F1 F2 F3 F4 F5 </pre>
5	<p>Press the CE key to clear the previous name, then enter a new user name, as follows:</p> <p>Spell the name by using the arrow keys to highlight the first letter, then press Enter, then highlight the second letter, then press Enter, etc. When you have finished spelling the name (up to six characters), press F1 (Accept).</p> <p>The Security Code screen appears again.</p>
6	<p>If you want to create a new PIN number, continue with step 4 of “Adding a User Name” on page 4-2. If not, press F5 (Cancel) to return to the Select User Name screen, which shows the changed user name.</p>

Deleting a User Name

You can delete a user name if there are no methods stored for that name.

To delete a user name:

Step	Action
1	<p>From the Main Menu, press F5 (User).</p> <p>The Select User Name screen appears.</p> <pre> Select User Name <<ab>> dave jenife murray adrian doug mamood nayana anna faye mike ngui Accept New Edit Delete Cancel F1 F2 F3 F4 F5 </pre>
2	<p>Use the arrow keys to highlight the user name you want to delete, then press F4 (Delete).</p> <p>The Select User Name screen is redisplayed minus the name you deleted.</p>

Creating a Method

Introduction A *method* is a set of instructions in which you specify how the instrument should heat and cool your samples in a PCR thermal profile. On the 2720 Thermal Cycler a method is represented graphically, as shown below on the Create/Edit screen. The graph is the wavy line in the middle.

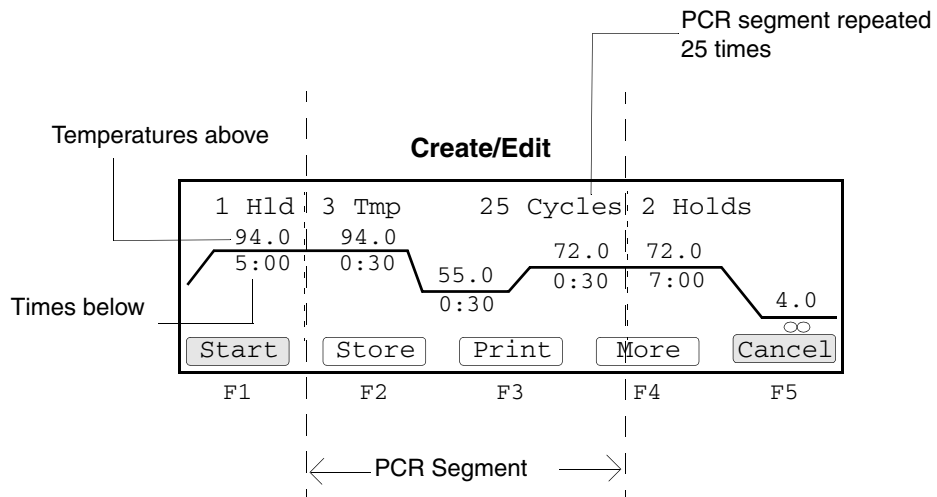

On the Create/Edit screen, temperatures are shown above the graph in degrees Celsius. Hold times in minutes and seconds are shown below the graph. The central portion of the screen, delineated by dashed lines, is the PCR segment. In this example, the PCR segment repeats 25 times. After PCR (in the post-PCR segment), the instrument holds the samples at 72 °C for 7 minutes, then cools to 4 °C and holds the samples at this temperature until you stop the run.

We call this the “Create/Edit screen” because it is the same screen with the same functions, whether you are creating a new method or editing an existing one. When you create a new method, the system provides a default method (shown above).

For an overview of the Create/Edit screen flow, see the chart on page C-4.

Before creating a method, you need to have added yourself as a user. You will be prompted for your user name when you attempt to store the method. For more information, see “Adding, Changing, or Deleting a User Name” on page 4-2.

Procedure To create a method:

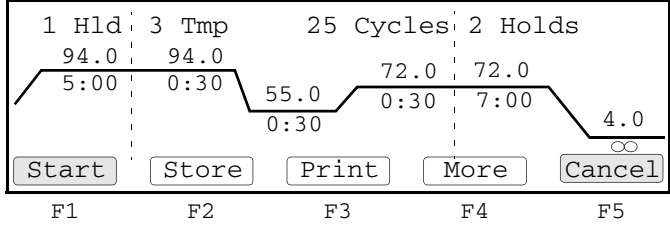
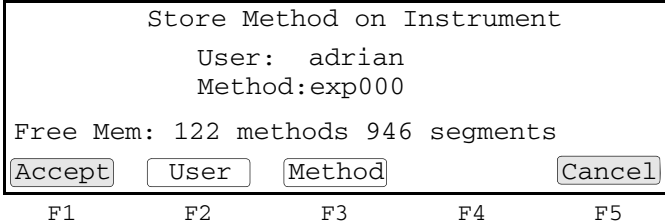
Step	Action										
1	<p>From the Main Menu, press F2 (Create).</p> <p>The Create/Edit screen appears.</p> 										
2	<p>Change times or temperatures or number of cycles by highlighting each parameter you want to change, typing in a new value with the numeric keys, then pressing Enter.</p> <table border="1" data-bbox="581 730 1464 1308"> <thead> <tr> <th>Parameter</th> <th>Explanation</th> </tr> </thead> <tbody> <tr> <td>Temperature</td> <td>The number above the graph in °C. Valid range is 4.0 °C to 99.9 °C.</td> </tr> <tr> <td>Time</td> <td>The number below the graph in <i>min:sec</i> format. Valid range is 00:00 to 99:59; however, a value of 99:00 or greater creates a hold time of ∞ that lasts indefinitely. A hold time of ∞ can be used only as the final hold time on the graph (in the post-PCR portion). For more information, see “About Post-PCR Parameters” on page 4-8.</td> </tr> <tr> <td>Hold</td> <td>Called Hld, Tmp, or Holds in the top line of the screen. This parameter determines the number of time/temperature segments in each portion of the graph delineated by dashed lines. In the pre-PCR portion, this value is usually 1. In the PCR portion (middle), 3 is typical for many PCR amplifications: template denaturation, primer annealing, and primer extension, although the valid range is 2–6.</td> </tr> <tr> <td>Cycles</td> <td>The number of times you want the PCR portion (middle) of the graph to repeat. Valid range is 2–99.</td> </tr> </tbody> </table> <p>If the method you want to create is more complex than the one shown above, continue with the procedure and create and store a method as close to your ideal one as possible, then see “Changing a Method Using Advanced Features” on page 4-9.</p>	Parameter	Explanation	Temperature	The number above the graph in °C. Valid range is 4.0 °C to 99.9 °C.	Time	The number below the graph in <i>min:sec</i> format. Valid range is 00:00 to 99:59; however, a value of 99:00 or greater creates a hold time of ∞ that lasts indefinitely. A hold time of ∞ can be used only as the final hold time on the graph (in the post-PCR portion). For more information, see “About Post-PCR Parameters” on page 4-8.	Hold	Called Hld, Tmp, or Holds in the top line of the screen. This parameter determines the number of time/temperature segments in each portion of the graph delineated by dashed lines. In the pre-PCR portion, this value is usually 1. In the PCR portion (middle), 3 is typical for many PCR amplifications: template denaturation, primer annealing, and primer extension, although the valid range is 2–6.	Cycles	The number of times you want the PCR portion (middle) of the graph to repeat. Valid range is 2–99.
Parameter	Explanation										
Temperature	The number above the graph in °C. Valid range is 4.0 °C to 99.9 °C.										
Time	The number below the graph in <i>min:sec</i> format. Valid range is 00:00 to 99:59; however, a value of 99:00 or greater creates a hold time of ∞ that lasts indefinitely. A hold time of ∞ can be used only as the final hold time on the graph (in the post-PCR portion). For more information, see “About Post-PCR Parameters” on page 4-8.										
Hold	Called Hld, Tmp, or Holds in the top line of the screen. This parameter determines the number of time/temperature segments in each portion of the graph delineated by dashed lines. In the pre-PCR portion, this value is usually 1. In the PCR portion (middle), 3 is typical for many PCR amplifications: template denaturation, primer annealing, and primer extension, although the valid range is 2–6.										
Cycles	The number of times you want the PCR portion (middle) of the graph to repeat. Valid range is 2–99.										
3	<p>When you have finished changing parameters, press F2 (Store).</p> <p>The Store Method on Instrument screen appears.</p> 										

To create a method: *(continued)*

Step	Action
4	<p>Note If you want to use the method name provided by the system (<i>e.g.</i>, exp000), skip to step 6. If you want to use a different name, press F3 (Method) to display the Method Name screen.</p> <div style="border: 1px solid black; padding: 5px; margin: 10px 0;"> <pre> Method Name exp001 abcdefghi jklmnopqrj stuvwxyz ., -+ / () := Use ENTER key to select a character. Accept Backsp Cancel F1 F2 F3 F4 F5 </pre> </div>
5	<p>Press the CE key to clear the method name, then spell out the new name by highlighting the first letter, then pressing Enter, highlighting the second letter, then pressing Enter, etc. Numeric keys can be used as well.</p> <p>When you have finished spelling the name, press F1 (Accept) to return to the Store Method on Instrument screen.</p>
6	<p>When the method name you want to use is displayed on the Store Method on Instrument screen, press F1 (Accept). Your method is stored and you are returned to the Main Menu.</p>

About Post-PCR Parameters

The post-PCR incubation temperature and hold time parameters define how to hold your samples at a specified temperature until you are ready to analyze them.

Note If the idle state setpoint, or the last hold of the method are below 15 °C, then the heated cover will automatically set to 50 °C

Typical Post-PCR Parameter Settings:

Temperature	Time (min:sec)	Use for
72 °C	7:00	Complete extension of all amplicons
72 °C	99:59 (x)	AmpErase® applications
4 °C	99:59 (x)	General storage

Changing a Method Using Advanced Features

Introduction The previous section told you how to create and store a method. If you want to change a method or make a more complex method, the features described in this section will help.

Editing a Method To edit an existing method:

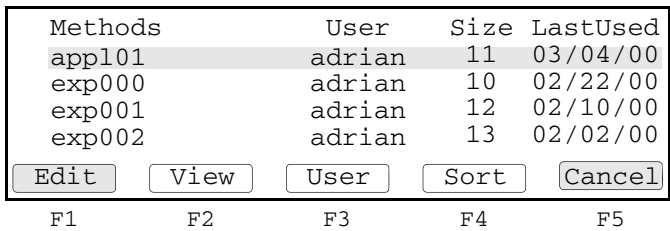
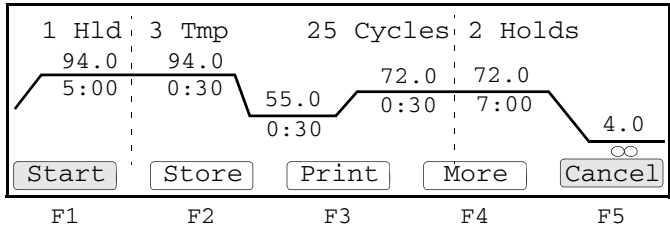
Step	Action																								
1	<p>From the Main Menu, press F3 (Edit).</p> <p>The Stored Methods screen appears.</p>  <table border="1"> <thead> <tr> <th>Methods</th> <th>User</th> <th>Size</th> <th>LastUsed</th> </tr> </thead> <tbody> <tr> <td>appl01</td> <td>adrian</td> <td>11</td> <td>03/04/00</td> </tr> <tr> <td>exp000</td> <td>adrian</td> <td>10</td> <td>02/22/00</td> </tr> <tr> <td>exp001</td> <td>adrian</td> <td>12</td> <td>02/10/00</td> </tr> <tr> <td>exp002</td> <td>adrian</td> <td>13</td> <td>02/02/00</td> </tr> </tbody> </table> <p> <input type="button" value="Edit"/> <input type="button" value="View"/> <input type="button" value="User"/> <input type="button" value="Sort"/> <input type="button" value="Cancel"/> </p> <p> F1 F2 F3 F4 F5 </p>	Methods	User	Size	LastUsed	appl01	adrian	11	03/04/00	exp000	adrian	10	02/22/00	exp001	adrian	12	02/10/00	exp002	adrian	13	02/02/00				
Methods	User	Size	LastUsed																						
appl01	adrian	11	03/04/00																						
exp000	adrian	10	02/22/00																						
exp001	adrian	12	02/10/00																						
exp002	adrian	13	02/02/00																						
2	<p>Highlight the method you want to change, then press F1 (Edit).</p> <p>The Create/Edit screen appears.</p>  <p> 1 Hld : 3 Tmp 25 Cycles : 2 Holds 94.0 : 94.0 72.0 : 72.0 5:00 : 0:30 0:30 : 7:00 55.0 : 4.0 </p> <p> <input type="button" value="Start"/> <input type="button" value="Store"/> <input type="button" value="Print"/> <input type="button" value="More"/> <input type="button" value="Cancel"/> </p> <p> F1 F2 F3 F4 F5 </p> <p>This screen is the same one that can be accessed by pressing F2 (Create) from the Main Menu. Once you have reached this screen, you can perform the same functions, regardless of how you accessed it.</p> <p>From this screen you can:</p> <table border="1"> <thead> <tr> <th>Action</th> <th>See Topic</th> <th>Page</th> </tr> </thead> <tbody> <tr> <td>Change parameters displayed on this screen</td> <td>Creating a Method</td> <td>4-6</td> </tr> <tr> <td rowspan="7">Use advanced features</td> <td>Inserting a Hold</td> <td>4-10</td> </tr> <tr> <td>Deleting a Hold</td> <td>4-11</td> </tr> <tr> <td>Inserting a Cycle</td> <td>4-12</td> </tr> <tr> <td>Inserting a Programmed Pause</td> <td>4-14</td> </tr> <tr> <td>Editing a Programmed Pause</td> <td>4-15</td> </tr> <tr> <td>Deleting a Programmed Pause</td> <td>4-16</td> </tr> <tr> <td>Auto-Incrementing/ Decrementing Temperature Control Parameters</td> <td>4-16</td> </tr> <tr> <td>Store the method</td> <td>Creating a Method</td> <td>4-6</td> </tr> </tbody> </table>	Action	See Topic	Page	Change parameters displayed on this screen	Creating a Method	4-6	Use advanced features	Inserting a Hold	4-10	Deleting a Hold	4-11	Inserting a Cycle	4-12	Inserting a Programmed Pause	4-14	Editing a Programmed Pause	4-15	Deleting a Programmed Pause	4-16	Auto-Incrementing/ Decrementing Temperature Control Parameters	4-16	Store the method	Creating a Method	4-6
Action	See Topic	Page																							
Change parameters displayed on this screen	Creating a Method	4-6																							
Use advanced features	Inserting a Hold	4-10																							
	Deleting a Hold	4-11																							
	Inserting a Cycle	4-12																							
	Inserting a Programmed Pause	4-14																							
	Editing a Programmed Pause	4-15																							
	Deleting a Programmed Pause	4-16																							
	Auto-Incrementing/ Decrementing Temperature Control Parameters	4-16																							
Store the method	Creating a Method	4-6																							

Inserting a Hold

A *hold* is a single time/temperature segment of a method, e.g., samples are held at 94.0 °C for 5 minutes, 00 seconds (5:00).

There are two ways you can insert a hold into a method:

- ◆ You can increment the value of the Hld, Tmp, or Holds fields on the Create/Edit screen, then press the Enter key. This adds a hold at the *far right* of the pre-PCR, PCR, or post-PCR segment, separated by dashed lines, respectively.
- ◆ You can use the procedure described below to insert a hold to the *left* of any segment.

To insert a hold:

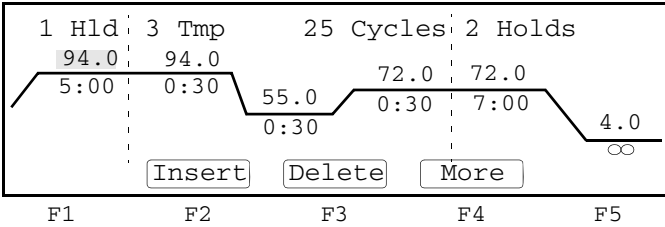
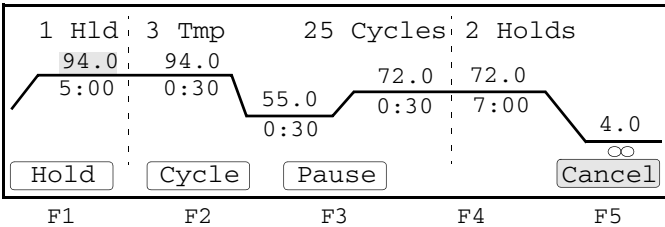
Step	Action
1	From the Create/Edit screen, use the arrow keys to highlight a time or temperature parameter to the <i>left</i> of which you want to insert a hold.
2	<p>Press F4 (More).</p> <p>The Insert-Delete-More screen appears.</p>  <p>Note The Modify function (F1) also displays if the highlighted parameter was in the PCR segment.</p>
3	<p>Press F2 (Insert).</p> <p>The Insert screen appears.</p>  <p>Note The Pause function will not display on the Insert screen if the highlighted segment already has a pre-programmed pause or if highlighter is not on a PCR segment parameter.</p>

To insert a hold: (continued)

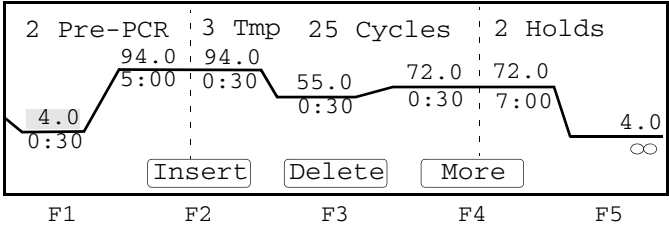
Step	Action
4	<p>Press F1 (Hold)</p> <p>The Insert-Delete-More screen appears showing the hold you added.</p>  <p>Note The Modify function (F1) also displays if the inserted hold was in the PCR segment.</p>
5	Change the temperature and time of the new hold as necessary.
6	Press F4 (More) to return to the Create/Edit screen.

Deleting a Hold

There are two ways to delete a hold:

- ◆ You can *decrement* the value of the Hld, Tmp, or Holds fields on the Create/Edit screen, then press Enter. This deletes a hold at the *far right* of the pre-PCR, PCR, or post-PCR segment, separated by dashed lines, respectively.
- ◆ You can use the procedure described below to delete a hold you highlight.

To delete a hold:

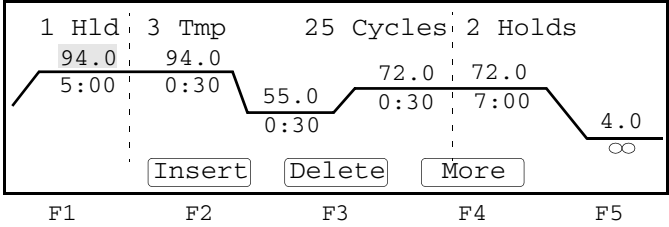
Step	Action
1	From the Create/Edit screen, use the arrow keys to highlight a time or temperature of a hold (segment) you want to delete.
2	<p>Press F4 (More).</p> <p>The Insert-Delete More screen appears.</p>  <p>Note The Modify function (F1) also displays if the highlighted parameter was in the PCR segment.</p>

To delete a hold: (continued)

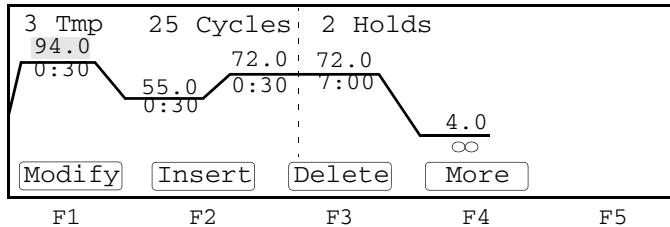
Step	Action
3	<p>Press F3 (Delete).</p> <p>The Insert-Delete-More screen redisplay minus the hold you deleted.</p>  <p>Note The Modify function (F1) also displays if the next highlighted parameter was in the PCR segment.</p>
4	Press F4 (More) to return to the Create/Edit screen.

Inserting a Cycle A cycle is a PCR portion of a method usually consisting of three time/temperature parameters and delineated by dashed lines. The instrument repeats these three temperatures and times for the number specified in the Cycles field (default is 25).

To insert a cycle:

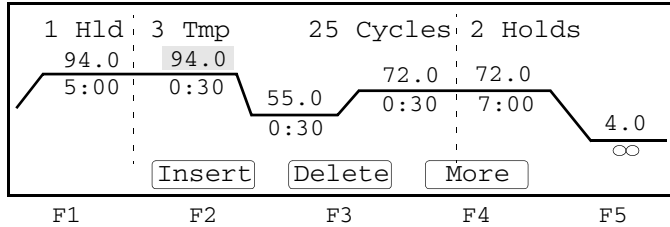
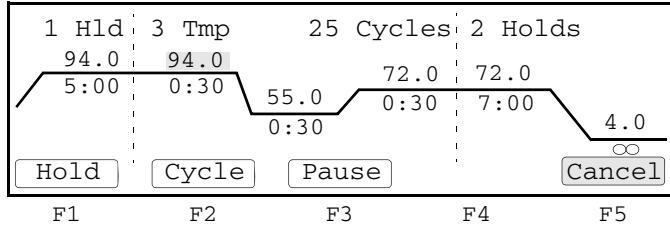
Step	Action
1	From the Create/Edit screen, use the arrow keys to highlight a time or temperature parameter to the <i>left</i> of which you want to insert a cycle.
2	<p>Press F4 (More).</p> <p>The Insert-Delete-More screen appears.</p>  <p>Note The Modify function (F1) also displays if the highlighted parameter was in the PCR segment.</p>
3	<p>Press F2 (Insert).</p> <p>The Insert screen appears.</p>  <p>Note The Pause function will not display on the Insert screen if the highlighted segment already has a pre-programmed pause or if highlighter is not on a PCR segment parameter.</p>

To insert a cycle: *(continued)*

Step	Action
4	<p data-bbox="586 279 768 306">Press F2 (Cycle)</p> <p data-bbox="586 321 1365 348">The Modify screen appears showing the cycle (PCR segment) you added.</p> <div data-bbox="586 359 1252 583" style="border: 1px solid black; padding: 5px;"> <p data-bbox="594 369 1243 396">1 Hld 3 Tmp 25 Cycles 3 Tmp 25 Cycles</p> <p data-bbox="594 407 1243 434">94.0 94.0 55.0 72.0 94.0 55.0 72.0</p> <p data-bbox="594 445 1243 472">5:00 0:30 0:30 0:30 0:30 0:30 0:30</p> <p data-bbox="594 516 1105 543">Modify Insert Delete More</p> <p data-bbox="634 558 1211 585">F1 F2 F3 F4 F5</p> </div>
5	Change the temperatures and times of the new cycle as necessary.
6	<p data-bbox="586 646 1133 674">Press F4 (More) to return to the Create/Edit screen.</p> <p data-bbox="586 688 1446 716">Note You can delete a cycle by entering 0 in the Tmp field, then pressing Enter.</p>

Inserting a Programmed Pause

A programmed pause is a point in the PCR portion of a method when cycling stops for a specified length of time. You define the frequency and length of the pause and the cycle at which it begins.

To insert a programmed pause:

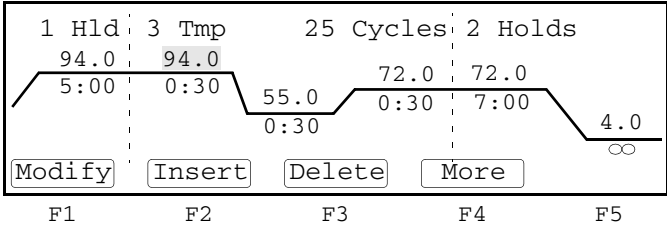
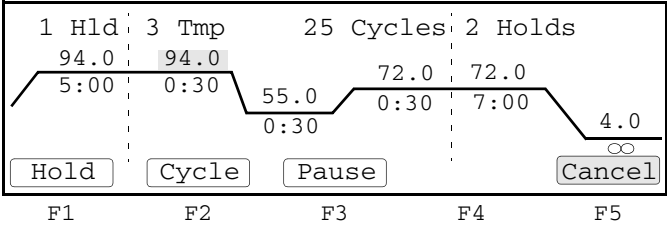
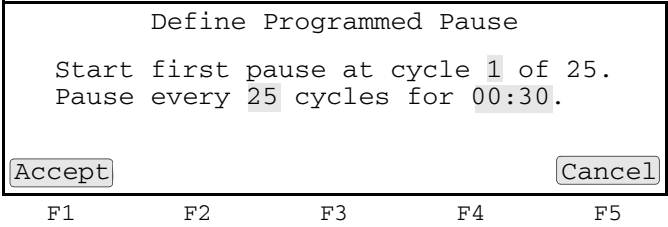
Step	Action
1	From the Create/Edit screen, use the arrow keys to highlight a time or temperature parameter of the PCR segment during which you want to insert a programmed pause.
2	<p>Press F4 (More).</p> <p>The Modify screen appears.</p> 
3	<p>Press F2 (Insert).</p> <p>The Insert screen appears.</p> 
4	<p>Press F3 (Pause).</p> <p>The Define Programmed Pause screen appears.</p>  <p>The fields that can be changed are highlighted in the illustration here.</p>
5	Type in the values you want to change. When you move the highlighter to No, the functions F2 (Yes) and F3 (No) become active. Press the appropriate key.

To insert a programmed pause: *(continued)*

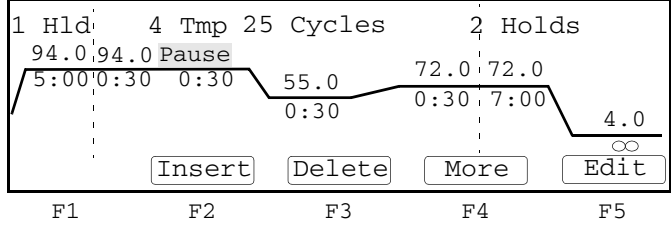
Step	Action
6	<p>Press F2 (Accept).</p> <p>The Insert-Delete-More-Edit screen appears showing the programmed pause you inserted.</p>  <p>Note You can insert only one pause in each cycle.</p>
7	Press F4 (More) to return to the Create/Edit screen.

Editing a Programmed Pause

If you have inserted a programmed pause in the PCR portion of your method, you can edit the parameters of the pause at any time.

To edit a programmed pause:

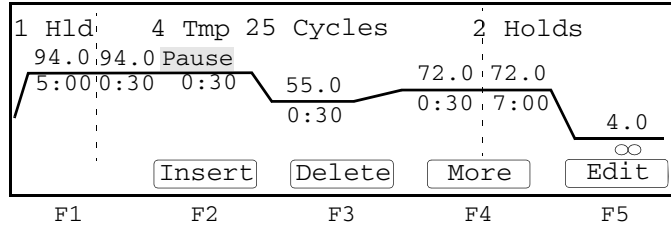
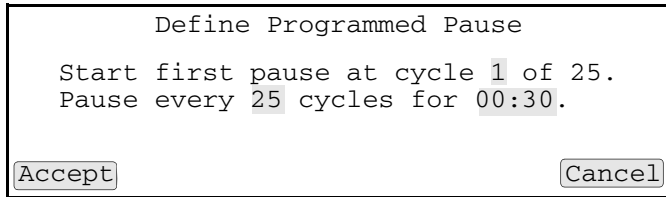
Step	Action
1	From the Create/Edit screen, use the arrow keys to highlight the word Pause .
2	<p>Press F4 (More).</p> <p>The Insert-Delete-More-Edit screen appears.</p> 
3	<p>Press F5 (Edit).</p> <p>The Defined Programmed Pause screen appears.</p>  <p>The fields that can be changed are highlighted in the illustration here.</p>
4	<p>Make your changes to any fields, then press F1 (Accept)</p> <p>The Insert-Delete-More-Edit screen appears again.</p>
5	Press F4 (More) to return to the Create/Edit screen.

Deleting a Programmed Pause

To delete a programmed pause:

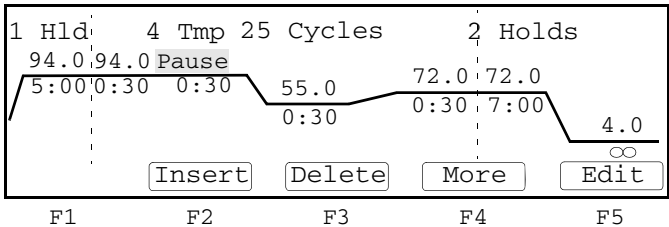
Step	Action
1	From the Create/Edit screen, use the arrow keys to highlight the word Pause.
2	Press F4 (More). The Insert-Delete-More-Edit screen appears. 
3	Press F3 (Delete). The Modify screen appears without the pause.
4	Press F4 (More) to return to the Create/Edit screen.

Auto-Incrementing/ Decrementing Temperature Control Parameters

Using the AutoX function, you can automatically increase or decrease the value for any PCR segment parameter a fixed amount every cycle.

Note This feature is particularly useful towards the end of the amplification process since the amount of PCR product, available to be extended, increases with the number of cycles while the amount of available enzyme remains constant.

To automatically increase or decrease temperature control parameters:

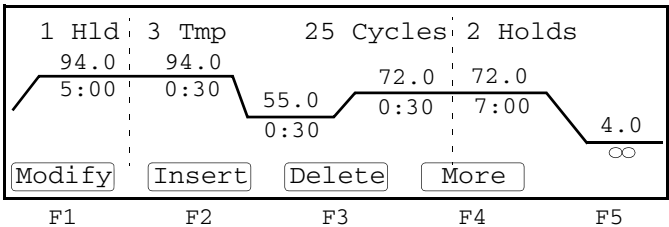
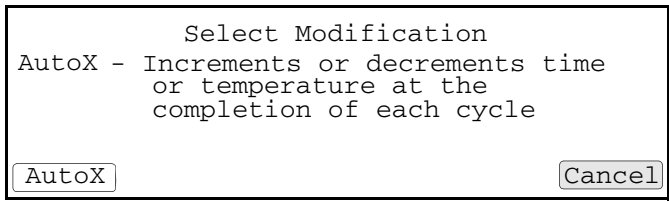
Step	Action
1	Use the arrow keys from the Create/Edit screen to select a time or temperature parameter in the PCR segment.
2	Press F4 (More). The Modify screen appears. 
3	Press F1 (Modify). The Select Modification screen appears. 

To automatically increase or decrease temperature control parameters: *(continued)*

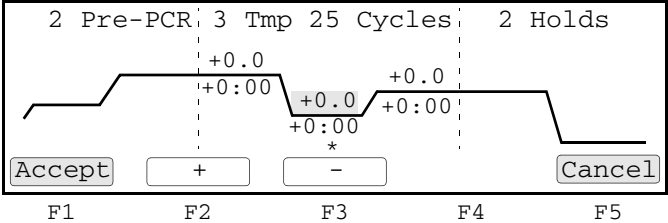
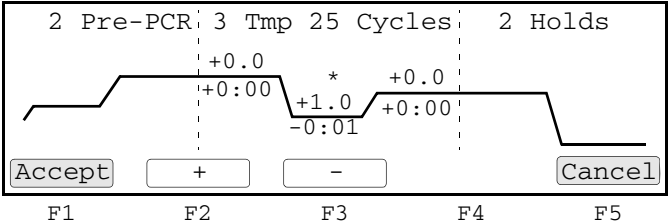
Step	Action
4	<p>Press F1 (AutoX).</p> <p>The AutoX screen appears.</p> 
<p>Note If you have inserted a programmed pause, the AutoX screen displays the pause, but you cannot modify it from the AutoX screen.</p>	
5	<p>Highlight the PCR time or temperature parameter that you want modified when you run your method.</p> <p>Note From the AutoX screen, you cannot modify the number of parameters in each segment or the number of cycles.</p>
6	<p>Use the numeric keypad to change numeric values. Press F2 (+) or F3 (-) to change the plus or minus signs.</p> <p>The selected sign displays in the current field. After you press Enter or an arrow key, an asterisk (*) appears for parameters that have been modified.</p> 
7	<p>Press F1 (Accept) to accept all entries on the AutoX screen and return to the Modify screen.</p>
8	<p>Press F4 (More) to return to the Create/Edit screen.</p>

Handling Methods

Introduction In this section we describe how to select a method, view method parameters, sort methods, search for a method, and print and delete a method.

Predefined Methods The 2720 Thermal Cycler supplies five predefined methods that you can run:

- ◆ AmpliTaq Gold®
- ◆ BigDye® Terminator
- ◆ General PCR
- ◆ Time Release PCR
- ◆ Touchdown PCR

Each of these methods is stored under the user name <<ab>>. You can edit these methods and store them under a different name, a different user name, or select any one and run it. For more information about these methods, see Appendix B, “Supplied Methods.”

Selecting a Method

If the method you want to run has already been created and stored, you can select it from a list. If the method you want to run has not been created, see “Creating a Method” on page 4-6.

To select a method:

Step	Action																				
1	<p>Access the Stored Methods screen. Most frequently you do this by pressing F2 (Run) or F3 (Edit) from the Main Menu.</p> <p>The Stored Methods screen appears.</p> <table border="1" data-bbox="589 548 1252 741"> <thead> <tr> <th>Methods</th> <th>User</th> <th>Size</th> <th>LastUsed</th> </tr> </thead> <tbody> <tr> <td>appl01</td> <td>adrian</td> <td>11</td> <td>03/04/00</td> </tr> <tr> <td>exp000</td> <td>adrian</td> <td>10</td> <td>02/22/00</td> </tr> <tr> <td>exp001</td> <td>adrian</td> <td>12</td> <td>02/10/00</td> </tr> <tr> <td>exp002</td> <td>adrian</td> <td>13</td> <td>02/02/00</td> </tr> </tbody> </table> <p> <input type="button" value="Edit"/> <input type="button" value="View"/> <input type="button" value="User"/> <input type="button" value="Sort"/> <input type="button" value="Cancel"/> </p> <p style="text-align: center;"> F1 F2 F3 F4 F5 </p> <p>About This Screen</p> <p>The top line of the display continuously cycles between the following three lines:</p> <ul style="list-style-type: none"> ◆ Methods User Size Stored <ul style="list-style-type: none"> – Stored represents the date the method was last saved. In the appropriate case, this column designates the date last used. – The units for the Size field are based on a calculation of the complexity and length of a method relative to a maximum size of 1102 size segments for the storage capacity of the instrument. ◆ Used Mem: xxx methods xxx segments <ul style="list-style-type: none"> – The Used Mem field displays the number of size segments used by all stored methods. ◆ Free Mem: xxx methods xxx segments <ul style="list-style-type: none"> – The Free Mem field displays the number of size segments available to store created methods. 	Methods	User	Size	LastUsed	appl01	adrian	11	03/04/00	exp000	adrian	10	02/22/00	exp001	adrian	12	02/10/00	exp002	adrian	13	02/02/00
Methods	User	Size	LastUsed																		
appl01	adrian	11	03/04/00																		
exp000	adrian	10	02/22/00																		
exp001	adrian	12	02/10/00																		
exp002	adrian	13	02/02/00																		
2	<p>If you need help deciding which method to select, you can:</p> <ul style="list-style-type: none"> ◆ View method parameters ◆ Sort methods by different categories ◆ Search for a method by user name <p>Each of these topics is discussed later in this section.</p>																				
3	<p>Select a method by using the up and down arrow keys to move the highlighter to a method listed on the Stored Methods screen.</p> <p>Note You can use the up and down arrow keys as repeat keys for quick scrolling.</p>																				
4	<p>Press F1 to continue the function you began.</p>																				

Viewing Method Parameters

To view the parameters of a method before running it:

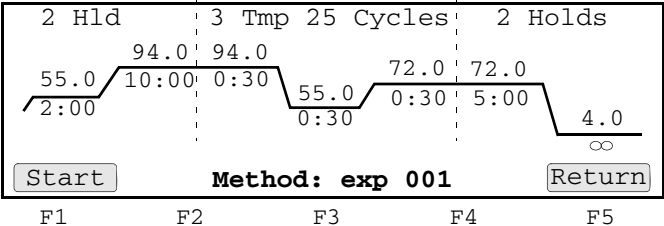
Step	Action
1	<p>Press F2 (View) from the Stored Methods screen.</p> <p>The View Method screen appears.</p> <p>The screen shows all the parameters of the method you selected.</p> 
2	<p>After reviewing PCR and post-PCR parameters of a stored method, you can:</p> <ul style="list-style-type: none"> ◆ Press F1 (Start) to start the method. ◆ Press F5 (Return) and return to the Stored Methods screen. <p>You cannot edit parameters from the View Method screen.</p>

Sorting Methods

If you have a large number of stored methods, you can sort them by name, date last used, date stored, and size.

To sort methods:

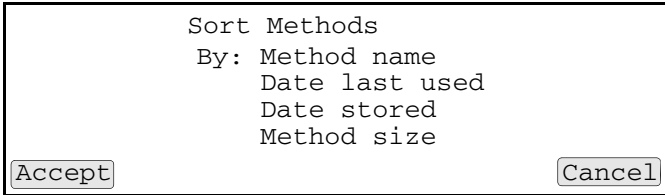
Step	Action
1	<p>Press F4 (Sort) from the Stored Methods screen.</p> <p>The Sort Methods screen appears.</p> 

To sort methods:

Step	Action										
2	<p>Use the up and down arrow keys to select the type of sort.</p> <p>The following table describes the sort methods.</p> <table border="1"> <thead> <tr> <th>Choose this item...</th> <th>To sort methods...</th> </tr> </thead> <tbody> <tr> <td>Method name</td> <td>alphabetically.</td> </tr> <tr> <td>Date last used</td> <td>chronologically in descending order by date of use. The last method which ran or was stored is listed first.</td> </tr> <tr> <td>Date stored Note Uses the most recent title and date, between date last used and the date stored.</td> <td>chronologically by date stored. The last method stored is listed first.</td> </tr> <tr> <td>Method size</td> <td>in increasing order by the amount of memory used to store each method. The largest size method is listed first.</td> </tr> </tbody> </table>	Choose this item...	To sort methods...	Method name	alphabetically.	Date last used	chronologically in descending order by date of use. The last method which ran or was stored is listed first.	Date stored Note Uses the most recent title and date, between date last used and the date stored.	chronologically by date stored. The last method stored is listed first.	Method size	in increasing order by the amount of memory used to store each method. The largest size method is listed first.
Choose this item...	To sort methods...										
Method name	alphabetically.										
Date last used	chronologically in descending order by date of use. The last method which ran or was stored is listed first.										
Date stored Note Uses the most recent title and date, between date last used and the date stored.	chronologically by date stored. The last method stored is listed first.										
Method size	in increasing order by the amount of memory used to store each method. The largest size method is listed first.										
3	<p>Press F1 (Accept) to accept a selection.</p> <p>This returns you to the Stored Methods screen where the displayed methods are sorted according to your selection in step 2.</p>										

Searching for Methods

You can find any method that has been stored under a user name.

To search for a method:

Step	Action												
1	<p>Press F3 (User) from the Stored Methods screen.</p> <p>The Select User Name screen appears.</p> <div style="border: 1px solid black; padding: 10px; margin: 10px 0;"> <p style="text-align: center;">Select User Name</p> <table style="width: 100%; border-collapse: collapse;"> <tr> <td style="width: 15%;"><<ab>></td> <td style="width: 25%;">dave</td> <td style="width: 25%;">jenife</td> <td style="width: 35%;">murray</td> </tr> <tr> <td>adrian</td> <td>doug</td> <td>mamood</td> <td>nayana</td> </tr> <tr> <td>anna</td> <td>faye</td> <td>mike</td> <td>ngui</td> </tr> </table> <p style="margin-top: 10px;"> <input type="button" value="Accept"/> <input type="button" value="All"/> <input type="button" value="Cancel"/> </p> <p style="text-align: center; font-size: small;"> F1 F2 F3 F4 F5 </p> </div>	<<ab>>	dave	jenife	murray	adrian	doug	mamood	nayana	anna	faye	mike	ngui
<<ab>>	dave	jenife	murray										
adrian	doug	mamood	nayana										
anna	faye	mike	ngui										
2	<p>From this screen you can:</p> <ul style="list-style-type: none"> ◆ Press F2 (All) to list all the methods currently stored on the instrument. ◆ Press F1 (Accept) to display the methods stored under the highlighted name. 												
3	<p>Making a selection returns you to the Stored Methods screen which now displays the methods of the user you selected.</p>												

Printing a Method

If you have a printer connected to your instrument and have configured your instrument for it, you can print a record of the parameters in a method. For more information see "Configuring the Instrument" on page 5-2.

To print a method:

Step	Action
1	From the Create/Edit screen, press F3 (Print). This prints a copy of the parameters for the method displayed on the screen.

Deleting a Method

To delete a method:

Step	Action																				
1	From the Main Menu press F4 (Util). The Utilities 1 screen appears. <div style="border: 1px solid black; padding: 10px; margin: 10px 0;"> <pre style="text-align: center;">Utilities Diag - Instrument diagnostics TmCalc - Calculates melting temp Config - Instrument configuration</pre> <div style="display: flex; justify-content: space-around; margin-top: 5px;"> Diag TmCalc Config More Exit </div> <div style="display: flex; justify-content: space-around; margin-top: 5px;"> F1 F2 F3 F4 F5 </div> </div>																				
2	Press F4 (More) The Utilities 2 screen appears. <div style="border: 1px solid black; padding: 10px; margin: 10px 0;"> <pre style="text-align: center;">Utilities Delete - Delete a Method Hist - Display history of last run</pre> <div style="display: flex; justify-content: space-around; margin-top: 5px;"> Delete Hist More Exit </div> <div style="display: flex; justify-content: space-around; margin-top: 5px;"> F1 F2 F3 F4 F5 </div> </div>																				
3	Press F1 (Delete). The Stored Methods screen appears. <div style="border: 1px solid black; padding: 10px; margin: 10px 0;"> <table style="width: 100%; border-collapse: collapse;"> <thead> <tr> <th style="text-align: left;">Methods</th> <th style="text-align: left;">User</th> <th style="text-align: left;">Size</th> <th style="text-align: left;">LastUsed</th> </tr> </thead> <tbody> <tr> <td>appl01</td> <td>adrian</td> <td>11</td> <td>03/04/00</td> </tr> <tr> <td>exp000</td> <td>adrian</td> <td>10</td> <td>02/22/00</td> </tr> <tr> <td>exp001</td> <td>adrian</td> <td>12</td> <td>02/10/00</td> </tr> <tr> <td>exp002</td> <td>adrian</td> <td>13</td> <td>02/02/00</td> </tr> </tbody> </table> <div style="display: flex; justify-content: space-around; margin-top: 5px;"> Delete View User Sort Cancel </div> <div style="display: flex; justify-content: space-around; margin-top: 5px;"> F1 F2 F3 F4 F5 </div> </div>	Methods	User	Size	LastUsed	appl01	adrian	11	03/04/00	exp000	adrian	10	02/22/00	exp001	adrian	12	02/10/00	exp002	adrian	13	02/02/00
Methods	User	Size	LastUsed																		
appl01	adrian	11	03/04/00																		
exp000	adrian	10	02/22/00																		
exp001	adrian	12	02/10/00																		
exp002	adrian	13	02/02/00																		

To delete a method: *(continued)*

Step	Action						
4	<p>Use the arrow keys to highlight the method you want to delete, then press F1 (Delete).</p> <p>The Delete Method screen appears.</p> <div data-bbox="586 401 1248 590" style="border: 1px solid black; padding: 5px; margin: 10px auto; width: fit-content;"> <pre style="font-family: monospace; text-align: center;"> Delete Method Methods on Inst User Size Stored exp001 adrian12 02/10/00 Press Yes to delete the method Yes Cancel </pre> </div> <p style="text-align: center;">F1 F2 F3 F4 F5</p>						
5	<p>Press F1 (Yes) to delete the method.</p> <table border="1" data-bbox="594 688 1450 955" style="width: 100%; border-collapse: collapse;"> <thead> <tr> <th data-bbox="594 688 1005 730">If the method was...</th> <th data-bbox="1005 688 1450 730">Then...</th> </tr> </thead> <tbody> <tr> <td data-bbox="594 730 1005 768">Unlocked</td> <td data-bbox="1005 730 1450 768">the method is deleted.</td> </tr> <tr> <td data-bbox="594 768 1005 955">Locked</td> <td data-bbox="1005 768 1450 955"> the Security Check screen appears. Type the PIN number, then press F1 (Accept). The Delete Method screen appears. Press F1 (Yes) to delete the method. </td> </tr> </tbody> </table> <p>After the method is deleted, the Stored Methods screen appears.</p> <p>Note Even after you delete the last method stored under a user name, the name is <i>not</i> removed from the instrument. To delete the name, see “Deleting a User Name” on page 4-5.</p>	If the method was...	Then...	Unlocked	the method is deleted.	Locked	the Security Check screen appears. Type the PIN number, then press F1 (Accept). The Delete Method screen appears. Press F1 (Yes) to delete the method.
If the method was...	Then...						
Unlocked	the method is deleted.						
Locked	the Security Check screen appears. Type the PIN number, then press F1 (Accept). The Delete Method screen appears. Press F1 (Yes) to delete the method.						

Utilities

5

Overview

About This Chapter This chapter provides information about almost all functions that can be performed from the Util (Utilities) selection on the Main Menu.

In This Chapter This chapter contains the following topics:

Topic	See Page
Configuring the Instrument	5-2
Upgrading System Firmware	5-4
Connecting to a Printer	5-5
Calculating the Melting Temperature	5-6
Running Hardware Diagnostics	5-7
Running the Calibration Verification Test	5-9
Running the Temperature Non-Uniformity Test	5-9
Running System Performance Diagnostics	5-10

Configuring the Instrument

Overview There are about six parameters or features you can enable or disable on the Applied Biosystems 2720 Thermal Cycler. These six fields are spread across two configuration screens. Pressing F4 (More) takes you from screen to screen in a circle.

Procedure To configure the instrument:

Step	Action										
1	<p>From the Main Menu, press F4 (Util).</p> <p>The Utilities 1 screen appears.</p> <div style="border: 1px solid black; padding: 10px; text-align: center;"> <p>Utilities</p> <p>Diag - Instrument diagnostics TmCalc - Calculates melting temp Config - Instrument configuration</p> <p> <input type="button" value="Diag"/> <input type="button" value="TmCalc"/> <input type="button" value="Config"/> <input type="button" value="More"/> <input type="button" value="Exit"/> </p> <p>F1 F2 F3 F4 F5</p> </div>										
2	<p>Press F3 (Config).</p> <p>The Configuration 1 screen appears. You can press F4 (More) to cycle from one configuration screen to the next.</p> <div style="border: 1px solid black; padding: 10px; text-align: center;"> <p>Instrument Configuration</p> <p>Time: 11:30 AM Date: 03/01/00 M/D/Y Run Time Printer: Off</p> <p> <input type="button" value="Accept"/> <input type="button" value="PM"/> <input type="button" value="24Hr"/> <input type="button" value="More"/> <input type="button" value="Cancel"/> </p> <p>F1 F2 F3 F4 F5</p> </div> <div style="border: 1px solid black; padding: 10px; text-align: center;"> <p>Instrument Configuration</p> <p>Pause Time Out: 10:00 (00:01-99:59) Idle State Setpoint: 25.0°C (4.0-99.9) Baud Rate: 9600</p> <p> <input type="button" value="Accept"/> <input type="button" value="More"/> <input type="button" value="Cancel"/> </p> <p>F1 F2 F3 F4 F5</p> </div>										
3	<p>On each configuration screen you can:</p> <table border="1"> <thead> <tr> <th>Action</th> <th>Explanation</th> </tr> </thead> <tbody> <tr> <td>Change field values</td> <td>Use arrow keys to highlight the value of the appropriate field, then see "Parameters" below.</td> </tr> <tr> <td>Press F1 (Accept)</td> <td>This stores your entries and returns to the Utilities 1 screen.</td> </tr> <tr> <td>Press F4 (More)</td> <td>This displays the next configuration screen.</td> </tr> <tr> <td>Press F5 (Cancel)</td> <td>This returns to the Utilities 1 screen without saving.</td> </tr> </tbody> </table>	Action	Explanation	Change field values	Use arrow keys to highlight the value of the appropriate field, then see "Parameters" below.	Press F1 (Accept)	This stores your entries and returns to the Utilities 1 screen.	Press F4 (More)	This displays the next configuration screen.	Press F5 (Cancel)	This returns to the Utilities 1 screen without saving.
Action	Explanation										
Change field values	Use arrow keys to highlight the value of the appropriate field, then see "Parameters" below.										
Press F1 (Accept)	This stores your entries and returns to the Utilities 1 screen.										
Press F4 (More)	This displays the next configuration screen.										
Press F5 (Cancel)	This returns to the Utilities 1 screen without saving.										

Parameters Below are parameters that are used on the configuration screens.

Field	Explanation										
Time	Use the numeric keys to enter the time. Choose AM, PM, or 24-Hour using the function keys.										
Date	Use the numeric keys to change the date. Choose M/D/Y, D/M/Y, or Y/M/D format for month, day, and year, using the function keys.										
Run Time Printer	Choose On or Off using the function keys. Enabling the printer allows you to print method parameters or records of run time events directly from the display screen. See "Connecting to a Printer" on page 5-5.										
Pause Time Out	Use the numeric keys to enter the minutes:seconds in the range shown on the configuration screen. This field sets the length of time the instrument pauses when you press F1 (Pause) or the Stop key from the Run Time screen. See "Pausing or Stopping a Run" on page 3-9.										
Idle State Setpoint	Use the numeric keys to type a temperature in the range shown on the configuration screen. This value is the temperature at which the instrument will remain when powered up but idle. IMPORTANT After a run is completed or terminated, there is approximately a 30-second delay before the instrument attains the specified idle state temperature. This allows you to stop one method and start another before the instrument temperature changes.										
Baud Rate	Use the function keys Up and Down to choose a baud rate. Values are 38400, 19200, 9600, 4800, 2400, 1200, and 600. This value is the rate at which the instrument transmits data through the printer port and serial port. <table border="1"> <thead> <tr> <th>Item</th> <th>Value</th> </tr> </thead> <tbody> <tr> <td>Baud Rate</td> <td>9600</td> </tr> <tr> <td>Parity</td> <td>NONE</td> </tr> <tr> <td>Data Bits</td> <td>8</td> </tr> <tr> <td>Stop Bits</td> <td>1</td> </tr> </tbody> </table>	Item	Value	Baud Rate	9600	Parity	NONE	Data Bits	8	Stop Bits	1
Item	Value										
Baud Rate	9600										
Parity	NONE										
Data Bits	8										
Stop Bits	1										

Upgrading System Firmware

About the Upgrade When a new version of system firmware becomes available, you can download it from our Web site, <http://www.appliedbiosystems.com/2720>. Instructions for performing the upgrade will also be posted on the Web site.

In order to perform the upgrade, you will need to connect a PC communication cable P/N N805-1327 to the RS485 port on the side of the 2720 Thermal Cycler (shown below) to a serial port on a Microsoft Windows®-based computer that has Internet access.



Connecting to a Printer

Introduction If you elect to connect an optional printer to your 2720 Thermal Cycler, you can print out a hard copy of the time and temperature parameters for PCR methods you create.

Specifications You can connect the 2720 Thermal Cycler to any printer with a serial (RS-232C) interface board and the following specifications:

Baud Rate	9600
Parity	NONE
Data Bits	8
Stop Bits	1

Cable Connections Connect one end of your Applied Biosystems (N805-1326) printer cable to the RS-485 serial port on the side panel of the 2720 Thermal Cycler and connect the other end to the serial adapter card port on the rear panel of the printer.

Installing a Printer See your printer manual for instructions on how to connect the printer cable to your printer and complete any other necessary installation steps.

After you have connected the printer cable and installed the printer, you must configure the instrument for the printer. See “Configuring the Instrument” on page 5-2.

Calculating the Melting Temperature

Procedure Use the T_m Calculator to determine the denaturation temperature of a primer set of known sequence.

To calculate the melting temperature:

Step	Action
1	<p>Press F4 (Util) from the Main Menu. The Utilities 1 screen appears.</p> <div style="border: 1px solid black; padding: 10px; text-align: center;"> <p>Utilities</p> <p>Diag - Instrument diagnostics TmCalc - Calculates melting temp Config - Instrument configuration</p> <p> <input type="button" value="Diag"/> <input type="button" value="TmCalc"/> <input type="button" value="Config"/> <input type="button" value="More"/> <input type="button" value="Exit"/> </p> <p>F1 F2 F3 F4 F5</p> </div>
2	<p>Press F2 (TmCalc).</p> <p>The T_m Calculator appears.</p> <div style="border: 1px solid black; padding: 10px;"> <p>[Salt]: 50 mM [Primer] 0.20 uM</p> <p>P1: 5'</p> <p>P2: 5'</p> <p>Tm of P1= Tm of P2=</p> <p>Press ENTER to calculate Tm's <input type="button" value="Return"/></p> </div>
3	<p>Enter the salt concentration.</p> <p>The default is 50. Enter values 5 to 1000.</p>
4	<p>Enter the primer concentration.</p> <p>The default is 0.20. Enter values 0.01 to 10.00.</p>
5	<p>Enter primer sequence in P1 using the function keys for A, C, G, or T.</p>
6	<p>Enter primer sequence in P2 and press Enter to calculate the T_ms.</p> <p>The melting points are displayed. Use this information to program a run.</p> <p>For more information, see Chapter 5, "Methods and Users."</p>
7	<p>Press F5 (Return) to display the Utilities 1 screen.</p>

Running Hardware Diagnostics

Overview The 2720 Thermal Cycler allows you to perform two hardware diagnostic tests:

- ◆ Visually determine if the Liquid Crystal Display (LCD) screen is functioning properly
- ◆ Verify the operation of the keypad

Both tests are performed from the Hardware Diagnostics screen.

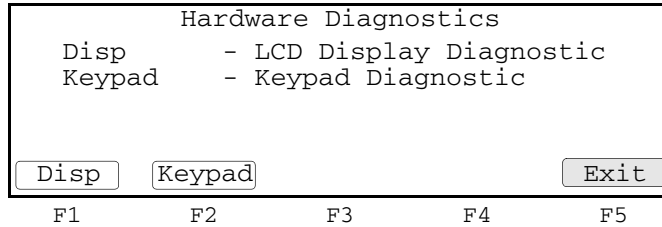

Testing the Display Screen

The Display diagnostic test allows you to visually determine if the display screen is properly functioning by turning on and off all the LCD pixels.

To test the display screen:

Step	Action
1	<p>Access the Display Diagnostics screen.</p> <ol style="list-style-type: none"> a. From the Main Menu press F4 (Util) to access the Utilities 1 screen. b. Press F1 (Diag) to display the Diagnostics screen. c. Press F1 (Hard) to display the Hardware Diagnostics screen. d. Press F1 (Disp). <p>The Display Diagnostics screen appears.</p>
2	Read and perform the instructions on the screen.

Testing the Keypad

Use the keypad diagnostic test to verify that all 22 keys on the control panel are functioning properly.

To test the keypad:

Step	Action												
<p>1</p>	<p>Access the Keypad Diagnostics screen.</p> <ol style="list-style-type: none"> From the Main Menu press F4 (Util) to access the Utilities 1 screen. Press F1 (Diag) to display the Diagnostics screen. Press F1 (Hard) to display the Hardware Diagnostics screen. Press F2 (Keypad). <p>The Keypad Diagnostic screen appears.</p> <div data-bbox="542 625 1203 821" style="border: 1px solid black; padding: 10px; text-align: center;"> <p>Keypad Diagnostic</p> <p>After pressing Run, press the blinking key or press STOP twice to exit.</p> <div style="display: flex; justify-content: space-around; margin-top: 10px;"> Run Exit </div> </div> <p style="text-align: center; margin-top: 5px;"> F1 F2 F3 F4 F5 </p>												
<p>2</p>	<p>Press F1 (Run).</p> <p>The Control Panel screen appears.</p> <div data-bbox="542 955 1203 1150" style="border: 1px solid black; padding: 10px; text-align: center;"> <div style="display: flex; justify-content: space-between; align-items: center;"> <div style="border: 1px solid black; padding: 2px 10px;">STOP</div> <div style="display: flex; gap: 5px;"> <div style="border: 1px solid black; padding: 2px 5px;">F1</div> <div style="border: 1px solid black; padding: 2px 5px;">F2</div> <div style="border: 1px solid black; padding: 2px 5px;">F3</div> <div style="border: 1px solid black; padding: 2px 5px;">F4</div> <div style="border: 1px solid black; padding: 2px 5px;">F5</div> </div> </div> <div style="display: flex; justify-content: center; align-items: center; margin: 10px 0;"> <table border="1" style="border-collapse: collapse; text-align: center;"> <tr><td>1</td><td>2</td><td>3</td></tr> <tr><td>4</td><td>5</td><td>6</td></tr> <tr><td>7</td><td>8</td><td>9</td></tr> <tr><td>ENTER</td><td>0</td><td>CE</td></tr> </table> <div style="margin: 0 20px;"> <div style="border: 1px solid black; padding: 2px 5px; text-align: center;">↑</div> <div style="display: flex; justify-content: center; gap: 5px;"> <div style="border: 1px solid black; padding: 2px 5px;">←</div> <div style="border: 1px solid black; padding: 2px 5px;">→</div> </div> <div style="border: 1px solid black; padding: 2px 5px; text-align: center;">↓</div> </div> </div> <p style="text-align: center; margin-top: 5px;"> F1 F2 F3 F4 F5 </p> </div>	1	2	3	4	5	6	7	8	9	ENTER	0	CE
1	2	3											
4	5	6											
7	8	9											
ENTER	0	CE											
<p>3</p>	<p>Press each indicated flashing key.</p> <p>After you have pressed each key in order, the test ends, and the Hardware Diagnostics screen appears.</p>												

Running the Calibration Verification Test

Why Use This Test? Use this test to verify the temperature calibration of your 2720 Thermal Cycler.

Equipment Required This test requires the 0.2-mL Temperature Verification System (P/N 4317939) for 96-well thermal cyclers.

For more information on performing the test, refer to the instructions included with your Temperature Verification System. Follow the procedure for the GeneAmp® PCR System 9700.

Running the Temperature Non-Uniformity Test

Why Use This Test? Use this test to verify the temperature non-uniformity of the sample block in the 2720 Thermal Cycler.

Equipment Required This test requires the 0.2-mL Temperature Verification System (P/N 4317939) for 96-well thermal cyclers.

For more information on performing the test, refer to the instructions included with your Temperature Verification System. Follow the procedure for the GeneAmp® PCR System 9700.

Running System Performance Diagnostics

Overview After you have configured the 2720 Thermal Cycler, conduct the system performance tests to verify the integrity of the cooling and heating system.

There are two system performance tests:

- ◆ Rate Test
- ◆ Cycle Test

IMPORTANT Before you begin these tests, make sure that you place an empty 96-well plate with full plate cover on the sample block (or use an empty tray and cover the wells with caps or the full plate cover). Close the heated cover, and pull the lever down.

Both of these tests are performed from the System Performance screen.

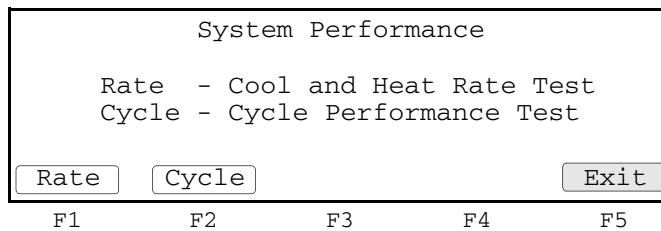

Running the Rate Test Use the Rate Test to verify that the Peltier units are operating correctly. The test takes approximately two minutes to run.

To run the Rate Test:

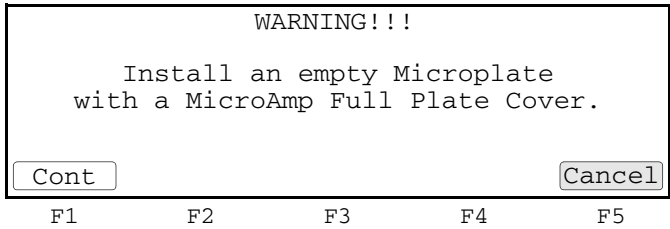
Step	Action
1	<p>Access the Warning screen.</p> <p>a. From the Main Menu press F4 (Util) to access the Utilities 1 screen.</p> <p>b. Press F1 (Diag) to display the Diagnostics screen.</p> <p>c. Press F2 (System) to display the System Performance screen.</p> <p>d. Press F1 (Rate).</p> <p>The Warning screen appears.</p> 
2	<p>After you have installed a plate and cover, press F1 (Cont).</p> <p>The instrument then runs through a series of tests where the sample block is stabilized at 35 °C, 94 °C, and 4 °C.</p>

To run the Rate Test: *(continued)*

Step	Action				
3	<p>At the conclusion of the test, the Cool and Heat Rate Test screen appears. The screen displays the test results and whether the test results passed or failed.</p> <div style="border: 1px solid black; padding: 5px; margin: 10px 0;"> <p style="text-align: right;">Cool and Heat Rate Test Pass</p> <p>Heating rate: x.xx °C/s Cooling rate: x.xx °C/s</p> <p><input type="button" value="Print"/> <input type="button" value="Cancel"/></p> <p style="text-align: center;">F1 F2 F3 F4 F5</p> </div> <p>The following table lists the passing ranges for the Rate Test.</p> <table border="1" style="margin-left: auto; margin-right: auto;"> <tr> <td>Heating Rate</td> <td>≥ 1.00 °C /second</td> </tr> <tr> <td>Cooling Rate</td> <td>≥ 1.00 °C /second</td> </tr> </table>	Heating Rate	≥ 1.00 °C /second	Cooling Rate	≥ 1.00 °C /second
Heating Rate	≥ 1.00 °C /second				
Cooling Rate	≥ 1.00 °C /second				

Running the Cycle Test

Use the Cycle Test to verify that the PCR cycling function operates properly. This test takes approximately 15 minutes to run.

To run the Cycle Test:

Step	Action
1	<p>Access the Warning screen.</p> <ol style="list-style-type: none"> a. From the Main Menu press F4 (Util) to access the Utilities 1 screen. b. Press F1 (Diag) to display the Diagnostics screen. c. Press F2 (System) to display the System Performance screen. d. Press F2 (Cycle). <p>The Warning screen appears.</p> <div style="border: 1px solid black; padding: 5px; margin: 10px 0;"> <p style="text-align: center;">WARNING!!!</p> <p style="text-align: center;">Install an empty Microplate with a MicroAmp Full Plate Cover.</p> <p><input type="button" value="Cont"/> <input type="button" value="Cancel"/></p> <p style="text-align: center;">F1 F2 F3 F4 F5</p> </div>
2	<p>After you have installed a plate cover, press F1 (Cont).</p> <p>The Cycle Test executes a standard PCR cycling reaction, measures, and reports the average cycle time, and the cycle to cycle variation.</p>
<p>Note Pressing Pause during the Cycle Test may generate false test results. Re-run the Cycle Test if Pause was pressed during the test.</p>	

To run the Cycle Test: *(continued)*

Step	Action				
3	<p data-bbox="539 277 1408 331">At the conclusion of the test, the display indicates test results and whether the test results passed or failed.</p> <div data-bbox="545 365 1208 558" style="border: 1px solid black; padding: 10px; margin: 10px 0;"> <p data-bbox="613 373 1133 403">Cycle Performance Pass</p> <p data-bbox="613 445 1075 474">Average Cycle Time: xxx.x sec</p> <p data-bbox="678 478 1075 508">Cycle Time STD: x.x sec</p> <p data-bbox="565 520 662 550">Print Cancel</p> </div> <p data-bbox="587 567 1166 592">F1 F2 F3 F4 F5</p> <p data-bbox="539 638 1188 667">The following table lists the passing ranges for the Cycle Test.</p> <table border="1" data-bbox="545 709 1117 785" style="margin: 10px 0;"> <tbody> <tr> <td data-bbox="555 718 831 747">Average Cycle Time</td> <td data-bbox="831 718 1110 747">≤ 129 sec</td> </tr> <tr> <td data-bbox="555 751 831 781">Cycle Time STD</td> <td data-bbox="831 751 1110 781">≤1.0 sec</td> </tr> </tbody> </table>	Average Cycle Time	≤ 129 sec	Cycle Time STD	≤1.0 sec
Average Cycle Time	≤ 129 sec				
Cycle Time STD	≤1.0 sec				

Maintenance

6

Overview

About This Chapter This chapter provides procedures for maintaining your Applied Biosystems 2720 Thermal Cycler.



WARNING Do not remove the instrument cover. There are no components inside the 2720 Thermal Cycler that you can safely service yourself. If you suspect a problem, refer to our Web site, <http://www.appliedbiosystems.com/2720>

In This Chapter This chapter contains the following topics:

Topic	See Page
Cleaning the Instrument	6-2
Replacing Fuses	6-4

Cleaning the Instrument

Preparation To clean the sample wells, raise the lid. The cleaning position is shown below.

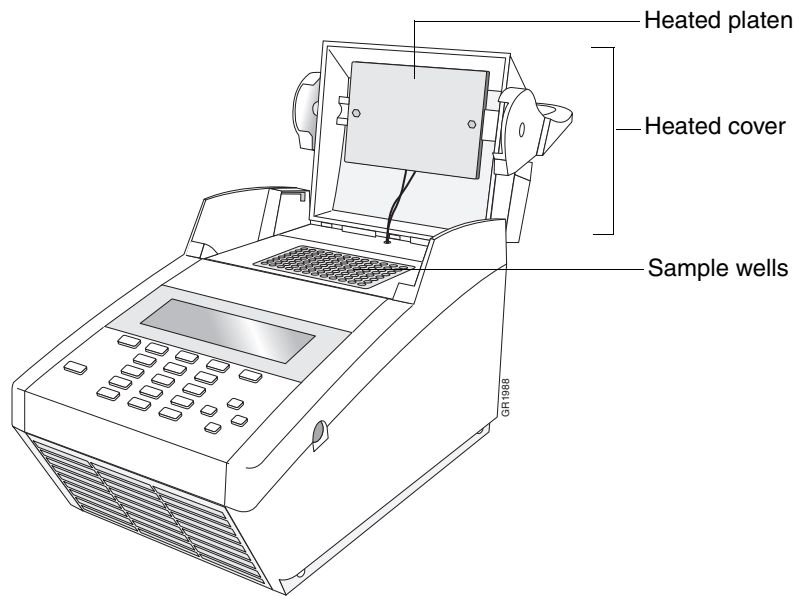

Cleaning the Sample Wells If you use any cleaning or decontamination method, except those recommended in the manual, you risk damaging the equipment. Clean the sample wells once a month or as needed.

 **WARNING** During instrument operation, the temperature of the heated cover can be as high as 108 °C, and the temperature of the sample block can be as high as 100 °C. Before performing the procedure, keep hands away until the heated cover and sample block reach room temperature

To clean the sample wells:

Step	Action
1	If a method is running, press the Stop key twice.
2	Turn off the instrument.
3	Wait 1 minute for the block to cool.
4	Lift the lever and open the hinged heated cover.
5	Remove the sample tray from the block and set it aside.
6	Use a cotton swab soaked in pure isopropanol to clean the sample wells thoroughly.

 **WARNING** **CHEMICAL HAZARD. Isopropanol** is a flammable liquid and vapor. Exposure may cause eye, skin, and upper respiratory tract irritation. Prolonged or repeated contact may dry skin and cause irritation. Exposure may cause central nervous system effects such as drowsiness, dizziness, and headache. Read the MSDS, and follow the handling instructions. Wear appropriate protective eyewear, clothing, and gloves.



To clean the sample wells: *(continued)*

Step	Action
7	<p>Remove any remaining isopropanol from the cover before reloading the sample tray.</p> <p>Note If the sample wells become contaminated from the samples, clean the wells thoroughly with a cotton swab soaked in bleach and then rinse with water.</p> <p> WARNING CHEMICAL HAZARD. Sodium hypochlorite (bleach) is a liquid disinfectant that can be corrosive to the skin and can cause skin depigmentation. Read the MSDS, and follow the handling instructions. Wear appropriate protective eyewear, clothing, and gloves.</p>

Cleaning the Heated Cover

 **WARNING** During instrument operation, the temperature of the heated cover can be as high as 108 °C, and the temperature of the sample block can be as high as 100 °C. Before performing the procedure, keep hands away until the heated cover and sample block reach room temperature.

To clean the heated cover:

Step	Action
1	If a method is running, press the Stop key twice.
2	Turn off the instrument.
3	Wait 20 to 30 minutes for the heated cover to cool down.
4	Lift the lever and open the hinged heated cover.
5	<p>Soak a cotton swab or piece of clean cloth with pure isopropanol and gently wipe the heated platen.</p> <p> WARNING CHEMICAL HAZARD. Isopropanol is a flammable liquid and vapor. Exposure may cause eye, skin, and upper respiratory tract irritation. Prolonged or repeated contact may dry skin and cause irritation. Exposure may cause central nervous system effects such as drowsiness, dizziness, and headache. Read the MSDS, and follow the handling instructions. Wear appropriate protective eyewear, clothing, and gloves..</p>
6	<p>Remove any remaining isopropanol from the cover.</p> <p>Note If the platen becomes contaminated with amplified DNA, then raise the heated cover to the cleaning position, and wipe the platen with a cloth or cotton swab soaked in bleach and then rinse with water.</p> <p> WARNING CHEMICAL HAZARD. Sodium hypochlorite (bleach) is a liquid disinfectant that can be corrosive to the skin and can cause skin depigmentation. Read the MSDS, and follow the handling instructions. Wear appropriate protective eyewear, clothing, and gloves.</p> <p>Clean the heated platen once a month or as needed.</p>

Replacing Fuses

Introduction All instruments have factory-installed fuses. If you need to change the fuses, use the procedure below.

 **WARNING FIRE HAZARD.** For continued protection against the risk of fire, replace fuses only with fuses of the type and rating specified for the instrument.

The fuse compartment is located at the instrument rear, as shown below.

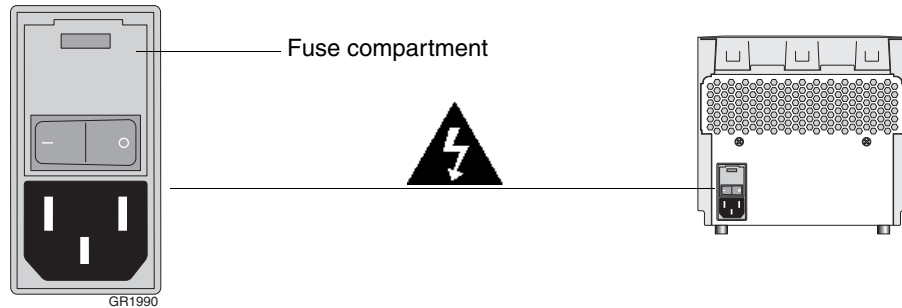

Items Needed

- ◆ Two fuses of the same type you are removing
- ◆ Fine flat-tip screwdriver

Procedure To replace the fuses:

Step	Action
1	<p>Turn off the 2720 Thermal Cycler and disconnect the power cord from the instrument rear.</p> <p> WARNING ELECTRIC SHOCK HAZARD. Severe electrical shock, which could cause physical injury or death, can result from working on an instrument when the high-voltage power supply is operating. To avoid electrical shock, disconnect the power cord to the instrument before opening the fuse compartment.</p> <p>Wait 30 seconds before any further work to let any electrical charges dissipate.</p>

To replace the fuses: *(continued)*

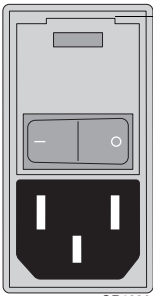
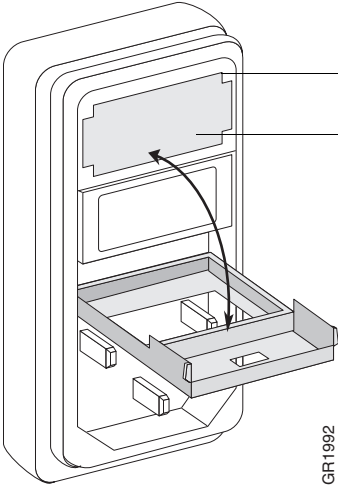
Step	Action
2	<p data-bbox="586 279 1446 338">Insert the screwdriver tip at the top edge of the fuse compartment door and pry it open.</p> <div data-bbox="634 373 1208 680"><p data-bbox="922 373 1208 403">Insert screwdriver tip here.</p><p data-bbox="732 663 786 680">GR1990</p></div> <p data-bbox="586 716 1062 745">The door opens to reveal the red fuse holder.</p>
3	<p data-bbox="586 756 1446 814">Insert the screwdriver tip at the edges of the red fuse holder and gently remove it from the instrument.</p> <div data-bbox="610 846 1382 1329"><p data-bbox="1101 905 1382 934">Insert screwdriver tip here</p><p data-bbox="1101 961 1230 991">Fuse holder</p><p data-bbox="1101 1150 1360 1180">Fuse compartment door</p><p data-bbox="927 1266 946 1329">GR1992</p></div>

To replace the fuses: *(continued)*

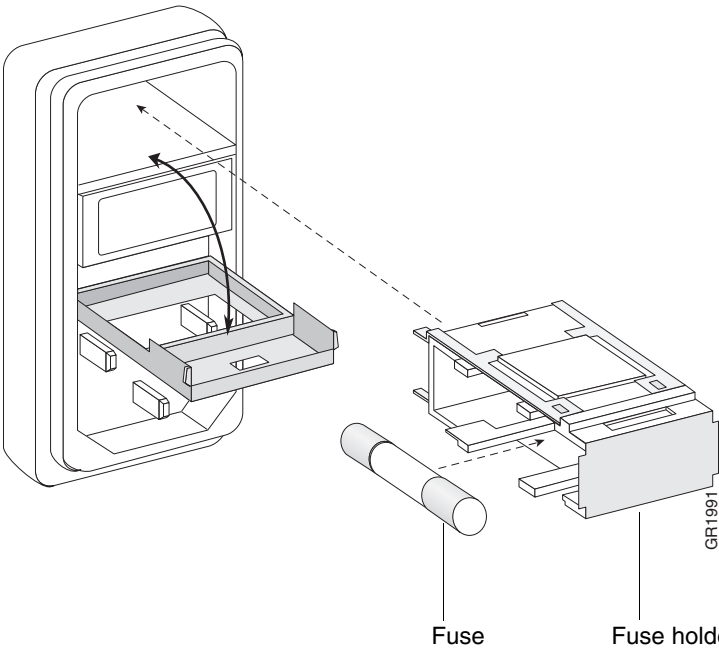
Step	Action
4	<p>Remove the two fuses from the fuse holder and replace them with two of the same type (as specified on label found on rear of instrument).</p> 
5	<p>Return the fuse holder to the instrument, and close the fuse compartment door. Press it until it locks into place.</p>
6	<p>Connect the instrument power cord.</p>

Troubleshooting

7

Overview

About This Chapter This chapter explains how to solve instrument problems.

In This Chapter This chapter contains the following topics:

Topic	See Page
If There's a Power Failure	7-2
Display Screen Error Messages	7-3
Troubleshooting Information	7-6

If There's a Power Failure

Automated Restart Function	An automated restart function allows for power outages and safe continuation of a PCR run after resumption of power.
-----------------------------------	--

If Power Is Interrupted	<p>The instrument does the following in a power failure:</p> <ol style="list-style-type: none">1. Restarts or continues the PCR experiment. The instrument determines what temperature was being approached, or was holding. Upon resumption of power, it will go to that temperature and count down the time remaining in the hold as soon as the temperature is within the specified clock start limit.2. Incubates the samples until such time as the experiment can be continued.3. Enters a record for any power outage in the history file.
--------------------------------	---

Display Screen Error Messages

User Input Error Messages The following table lists user input error messages, a description of the message, and recommended action.

Message	Description	Recommended Action
Can only enter an infinity hold at end	A method can only have a Hold segment with an infinity hold as the last segment in a method. This message occurs when you try to enter an infinity hold segment in the middle of a method.	Assign finite time segments to holds within a method.
Delete your methods first	User tried to delete a user name that has methods stored under it.	Delete or transfer the associated methods before deleting a user name.
Enter a name or CANCEL	You did not enter at least one character on the User Name screen before pressing the Accept key.	Enter the user name to which the desired method is assigned.
Enter oligo sequence	Incomplete TmCalc data.	Enter a value in the P1 and P2 fields of the TmCalc.
Enter user and method names or CANCEL	You did not enter a user name and a method name before storing a method.	Specify the method name and choose a user to store a method.
Field is full	You tried to enter more data in a field than the field size allows.	Reenter data within the specifications of the field.
Infinity hold not allowed in cycle	A method can have an infinity hold segment as the last segment in the method. This message occurs when you tried to enter an infinity time in a cycle segment.	Use finite values for cycle segments within the method.
Invalid password/pin#	You entered an incorrect PIN#.	Enter the correct PIN#.
List of user names is full	The maximum number of users has been entered into the system.	Delete unused user names.
Maximum of 6 segments allowed	You tried to insert more than six temperature control parameters into a hold or cycle.	Do not assign more than six hold or cycle parameters to a method.
Method battery RAM initialized	Stored methods have been reset due to hardware or software failure. Not all methods may be lost.	Check method directory. Refer to our Web site. ^a
Method requires at least one segment	You deleted all temperature control parameters in a method. A method must have at least one time and temperature parameter.	Review and correct the method to include the temperature parameter(s).
No seconds in time field	You did not include seconds in the time field.	Include seconds when entering the time.
Not enough method memory left	This error occurs: <ul style="list-style-type: none"> ◆ When you attempt to exceed the limit of 137 methods. ◆ When you attempt to store or create a new method that is larger than the available storage space. 	<ul style="list-style-type: none"> ◆ Determine how much storage memory is available on the instrument. ◆ Delete or store rarely used methods elsewhere.

Message	Description	Recommended Action
Not implemented yet	The feature is not implemented in the current firmware version.	Upgrade firmware when the new version is available from Applied Biosystems.
Printer not responding	The printer has been disconnected or is off line.	Check printer connections and power switch.
Remove infinity hold first	A method can have an infinity hold segment as the last segment in the method. This message occurs when a user tries to add a segment after one which contains an infinity hold.	Add segments prior to the post-PCR infinity hold.
T _m temperature out of range	T _m out of range.	Check input value and retry.
User name already defined	You entered a user name that already exists.	Do not duplicate user names.
Valid range is	You entered a number out of range. The message include the valid range limits.	Re-enter a value within the parameters of the field.

a. <http://www.appliedbiosystems.com/support/contact/>

Serious Error Messages The following table lists error messages that may indicate a serious problem such as hardware malfunction. A description of the problem and recommended action are provided.

Message	Description	Recommended Action						
Error 1	Block shut off by hardware due to thermal runaway.	Note the error number, and refer to our Web site. ^a						
Error 2	Block thermal runaway							
Error 3	Heated cover shut off by hardware due to thermal runaway.							
Error 4	Heat sink is too hot. Ambient conditions may be too warm.	<p>Ensure that the fan is running and instrument vents are clear.</p> <p>Move instrument to well-ventilated location (15–30 °C).</p> <p>Run rate test diagnostic.</p> <p>Note the error number, and refer to our Web site.^a</p>						
Error 5	Heat sink sensor failure	Note the error number, and refer to our Web site. ^a						
Error 6	Heated cover thermal runaway							
Error 7	Heated cover sensor failure							
Error 8	<p>Setpoint could not be reached</p> <ul style="list-style-type: none"> ◆ The instrument could not reach a temperature parameter set by the user. The unit has a Peltier or power amplifier failure. ◆ Ambient conditions may be out of recommended range. 	<table border="1"> <thead> <tr> <th>If this error occurs...</th> <th>Then...</th> </tr> </thead> <tbody> <tr> <td>immediately after a firmware upgrade</td> <td>Switch the instrument power off, then on again.</td> </tr> <tr> <td>any other time</td> <td>See recommended actions for Error 4.</td> </tr> </tbody> </table>	If this error occurs...	Then...	immediately after a firmware upgrade	Switch the instrument power off, then on again.	any other time	See recommended actions for Error 4.
If this error occurs...	Then...							
immediately after a firmware upgrade	Switch the instrument power off, then on again.							
any other time	See recommended actions for Error 4.							
Error 9	Sample block sensor failure	Note the error number, and refer to our Web site. ^a						
Error 10	Battery RAM version number lost ^b							
Error 11	Bus error							
Error 12	Calibration battery RAM initialized ^b Instrument may not perform to specification.							
Error 13	System can't allocate timer							
Error 14	Stack overflow software error							
Error 15	LCD screen timed-out							
Error 16	Preferences battery RAM initialized ^b User configuration has been reset due to software error.							
Error 17	Invalid pointer system error.							
Error 18	Watchdog timeout software failure.							

a. <http://www.appliedbiosystems.com/support/contact/>

b. If your instrument has been in storage for more than 3 months, it is possible that the battery has lost its charge but can recover. Contact Applied Biosystems Technical Support.

Troubleshooting Information

Troubleshooting Table The following table lists the problem, possible causes, and a check and/or remedy for troubleshooting the 2720 Thermal Cycler.

Problem	Possible Causes	Check and/or Remedy
Control panel not responding	<ul style="list-style-type: none"> ◆ Key stuck in down position. ◆ Keypad failure. 	<ul style="list-style-type: none"> ◆ Look for depressed key and free it. ◆ Run keypad diagnostic. Refer to our Web site. ^a
Cooling rate too slow	<ul style="list-style-type: none"> ◆ Ambient temperature is too warm. ◆ Peltier failure. 	<ul style="list-style-type: none"> ◆ Move instrument to well-ventilated location (15–30 °C). ◆ Run rate test diagnostic. Refer to our Web site. ^a
Cycling time too long	Peltier failure.	Run cycle test diagnostic.
Displayed temperature does not match specified temperature	Instrument may require calibration.	Run the temperature verification test. Refer to our Web site. ^a
Heated cover not responsive	Heated cover failure.	Refer to our Web site. ^a
Heating rate too slow	Peltier failure.	Run rate test diagnostic. Refer to our Web site. ^a
Instrument can't reach high or low temperature range	<ul style="list-style-type: none"> ◆ Peltier failure. ◆ Ambient temperature too warm. 	<ul style="list-style-type: none"> ◆ Run rate test diagnostic. ◆ Run cycle test diagnostic. Refer to our Web site. ^a
Instrument making too much noise	Fan failure.	Check for vent obstructions.
No screen display No response when you turn the instrument on	<ul style="list-style-type: none"> ◆ Fuse blown. ◆ Not connected to power source. 	<ul style="list-style-type: none"> ◆ Is power switch ON? ◆ Is power cord connected? ◆ Check fuses.
Printer fails	<ul style="list-style-type: none"> ◆ Incorrect printer configuration. ◆ Incorrect printer cable. 	<ul style="list-style-type: none"> ◆ Check printer for baud rate = 9600, no parity, one stop bit, eight data bits. ◆ Purchase Applied Biosystems printer cable.
Whirring fan does not sound	<ul style="list-style-type: none"> ◆ Fuse blown. ◆ Not connected to power source. 	<ul style="list-style-type: none"> ◆ Is power switch ON? ◆ Is power cord connected? ◆ Check fuses. Refer to our Web site. ^a

a. <http://www.appliedbiosystems.com/support/contact/>

Specifications



Overview

About This Appendix

This appendix provides specifications for the Applied Biosystems 2720 Thermal Cycler.

System Specifications

Dimensions The table below lists the footprint and the weight of the 2720 Thermal Cycler.

Footprint	
Note You must provide sufficient space around the instrument for unrestricted air circulation.	
Height	21.5 cm (8.5 in)
Width	21 cm (8.25 in)
Depth	35 cm (14 in)
Weight	
Instrument	5.9 kg (13 lbs)

Power Configurations There is one version of the 2720 Thermal Cycler. The power requirements of the instrument under various power configurations are:

VAC ~100/120	8 AMP T (5x20 mm) or 8 AMP slow blow (3 AB)	50/60 Hz Use 250 V fuses
VAC ~220/230/240	8 AMP T (5x20 mm)	Max Power 420 VA

Control Panel Specifications

Display Screen The display screen is a 7 x 40 character display with a 60 x 240 pixel resolution graphics mode.

Keys The instrument control panel consists of a display screen and 22 keys:

- ◆ 5 function keys
- ◆ 4 arrow keys
- ◆ Stop key
- ◆ Enter key
- ◆ 10-number keypad
- ◆ CE key

Sample Temperature Information

Temperature The table below lists sample temperature information.

Note Sample temperatures are displayed in degrees Celsius to the nearest 0.1 °C.

Sample Temperature Range	4.0 to 99.9 °C.
Temperature Calibration	Traceable to National Institute of Standards and Technology (NIST).

Printer Specifications

Serial Interface Board Specifications The 2720 Thermal Cycler can use any printer with a serial (RS-232C) interface board with the following parameters.

Baud Rate	9600
Parity	NONE
Data Bits	8
Stop Bits	1

Cable Part Number Connect the printer to the instrument port with printer cable part number N805-1326.

Supplied Methods

B

Overview

About This Appendix	This appendix describes precoded methods supplied with your instrument.
----------------------------	---

About the Methods

Five Precoded Methods The Applied Biosystems 2720 Thermal Cycler supplies you with five precoded methods stored under the user name <<ab>>:

- ◆ AmpliTaq Gold®
- ◆ BigDye® Terminator
- ◆ General PCR
- ◆ Time Release PCR
- ◆ Touchdown PCR

AmpliTaq Gold The AmpliTaq Gold protocol specifies a 5-minute pre-PCR heat step, required for the activation of AmpliTaq Gold® DNA Polymerase. This additional step provides seamless “hot start” PCR and replaces labor intensive methods such as manual hot start or wax bead-mediated hot start techniques.

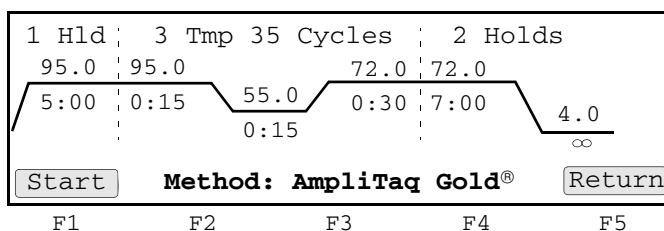

Utilizing hot start techniques helps to minimize the formation of primer-dimers or non-specific products, thus increasing specificity and sensitivity of PCR.

You can find further information on AmpliTaq Gold DNA Polymerase in the product insert (P/N N808-0241) or at the Applied Biosystems Web site.

BigDye® Terminator The BigDye® Terminator protocol is used for cycle sequencing. It consists of 3-temperature PCR for 25 cycles followed by an infinite hold at 4 °C.

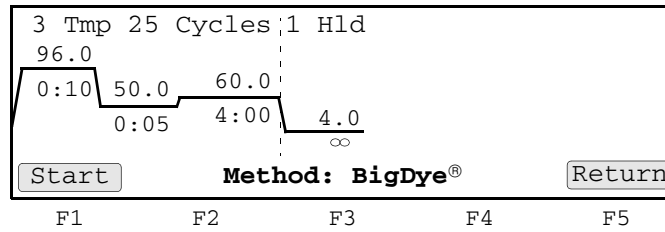

The reagents used include the sequencing enzyme AmpliTaq® DNA Polymerase, FS, and fluorescent labeled dye terminators. Four different fluorescent dyes, one for each base, are incorporated into extension products. These products can then be purified. Subsequently, electrophoresis and data analysis can be performed on them. This process is further described in the protocol *ABI PRISM® BigDye® Terminator Cycle Sequencing Ready Reaction Kits* (P/N 4303237).

General PCR The General PCR method is a basic one and can be easily modified with both pre- and post-PCR holds.

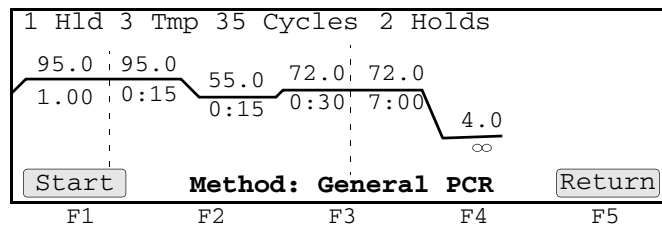

Time Release PCR The Time Release PCR method is designed for use with AmpliTaq Gold DNA Polymerase. The enzyme is activated more slowly than with the AmpliTaq Gold method. Here the pre-PCR hold is only 1 minute, and the number of cycles is increased to 40.

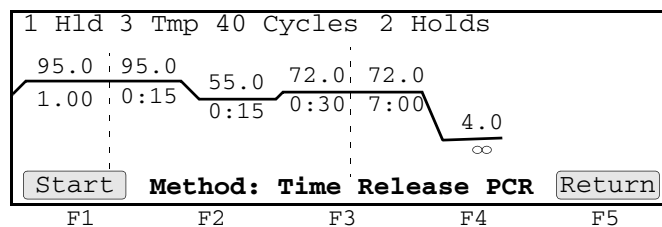

Touchdown PCR When the optimal annealing temperature is unknown, one strategy, Touchdown PCR, incrementally decreases the annealing temperature in early cycles in order to maximize the yield of specific products.

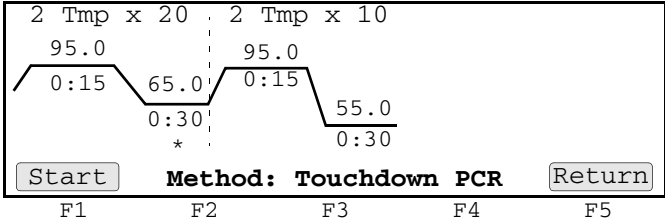

This supplied method has an initial annealing temperature (65 °C) that incrementally decreases by an additional 0.5 °C in each of the first 20 cycles, followed by 10 cycles at 55 °C.

Screen Flowcharts

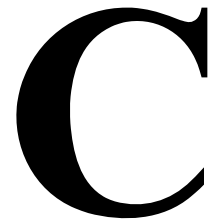

Overview

About This Appendix This appendix provides flowcharts showing screen flows for various functions you might want to use. These charts provide an overview of a procedure.

In This Appendix Flowcharts are included for the following topics:

Topic	See Page
Run	C-2
Stop or End of Run	C-3
Create/Edit	C-4
User	C-5
Utilities	C-6
Diagnostics	C-7
Upgrade	C-8

Run

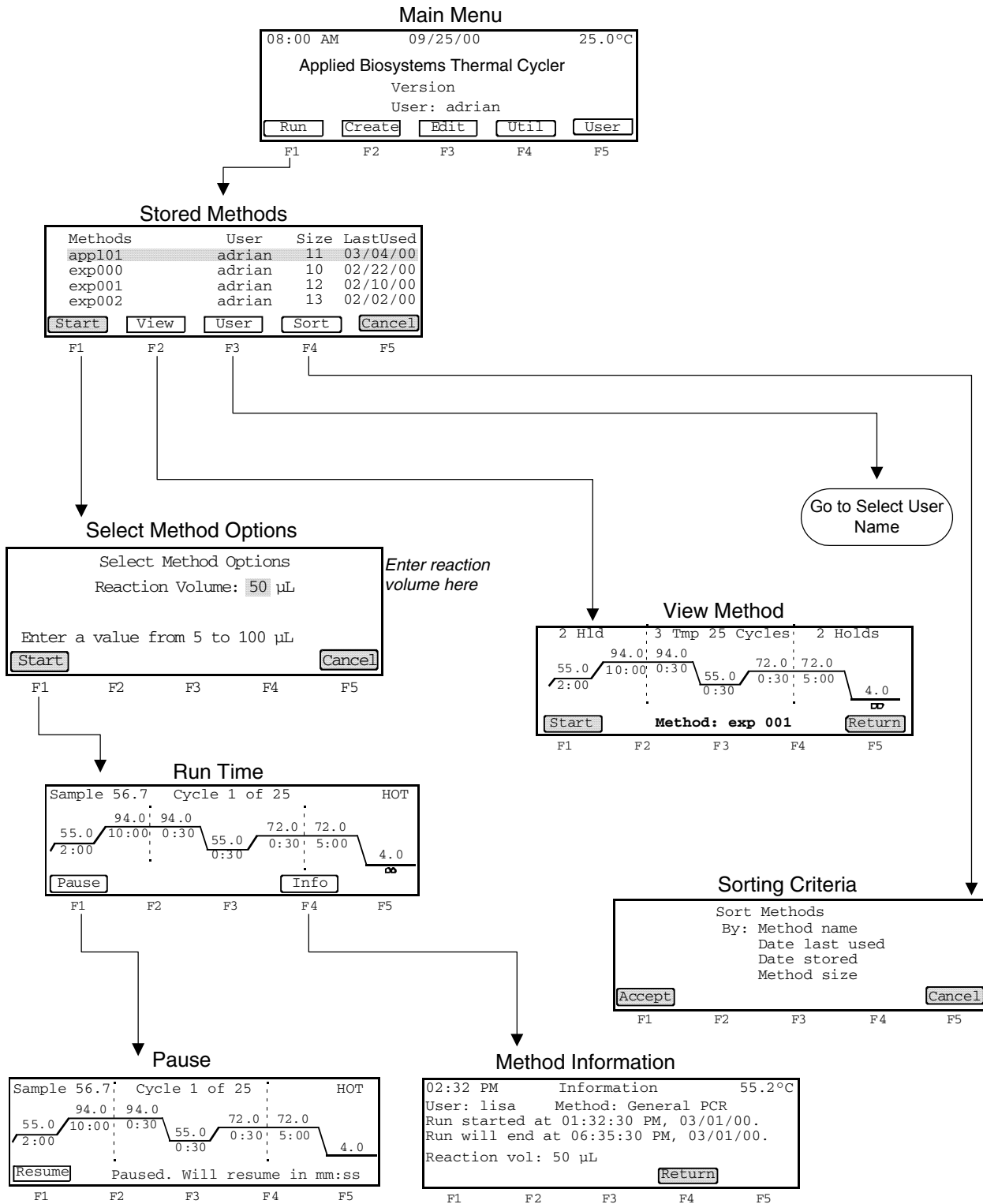

Stop or End of Run

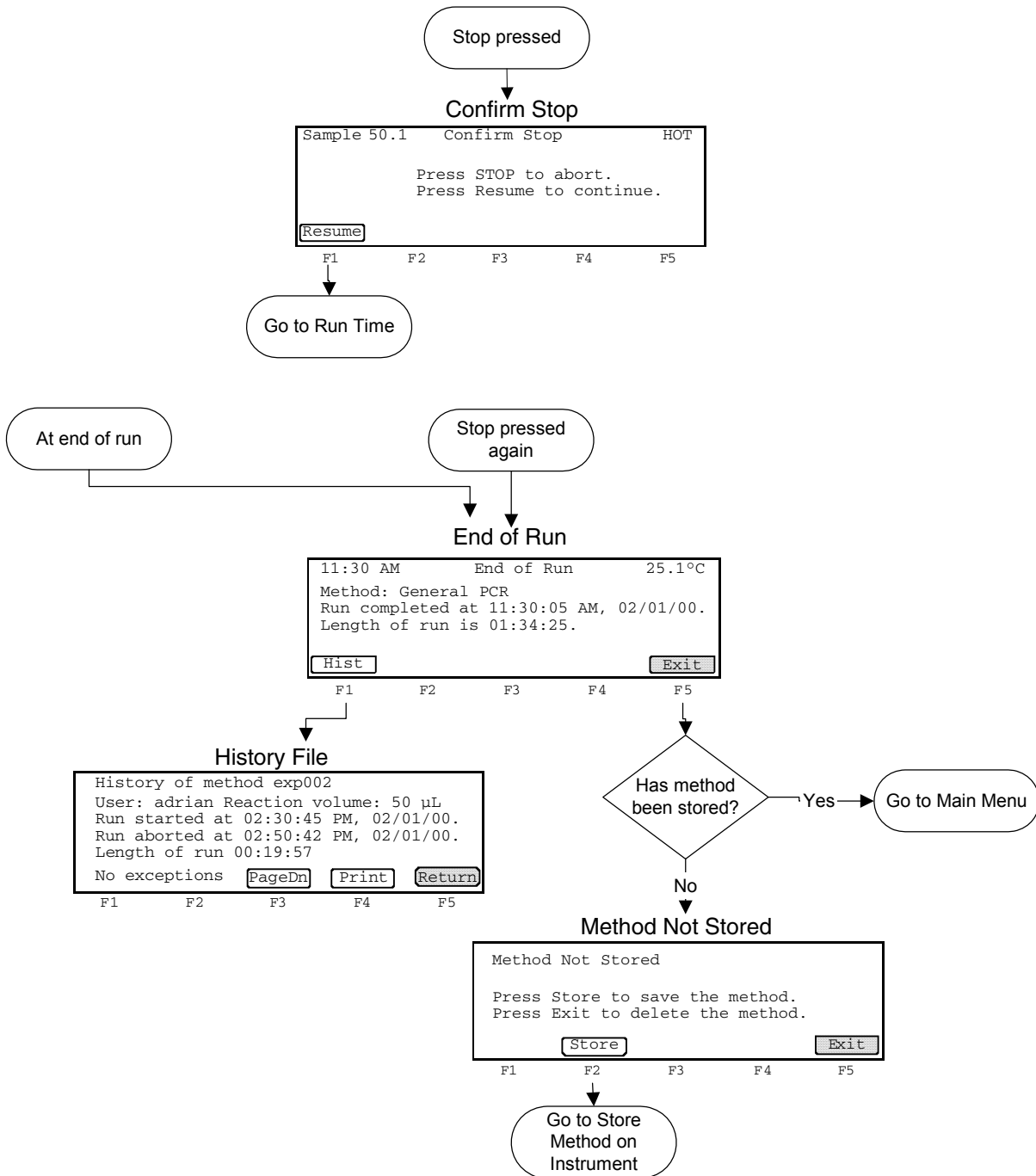

Create/Edit

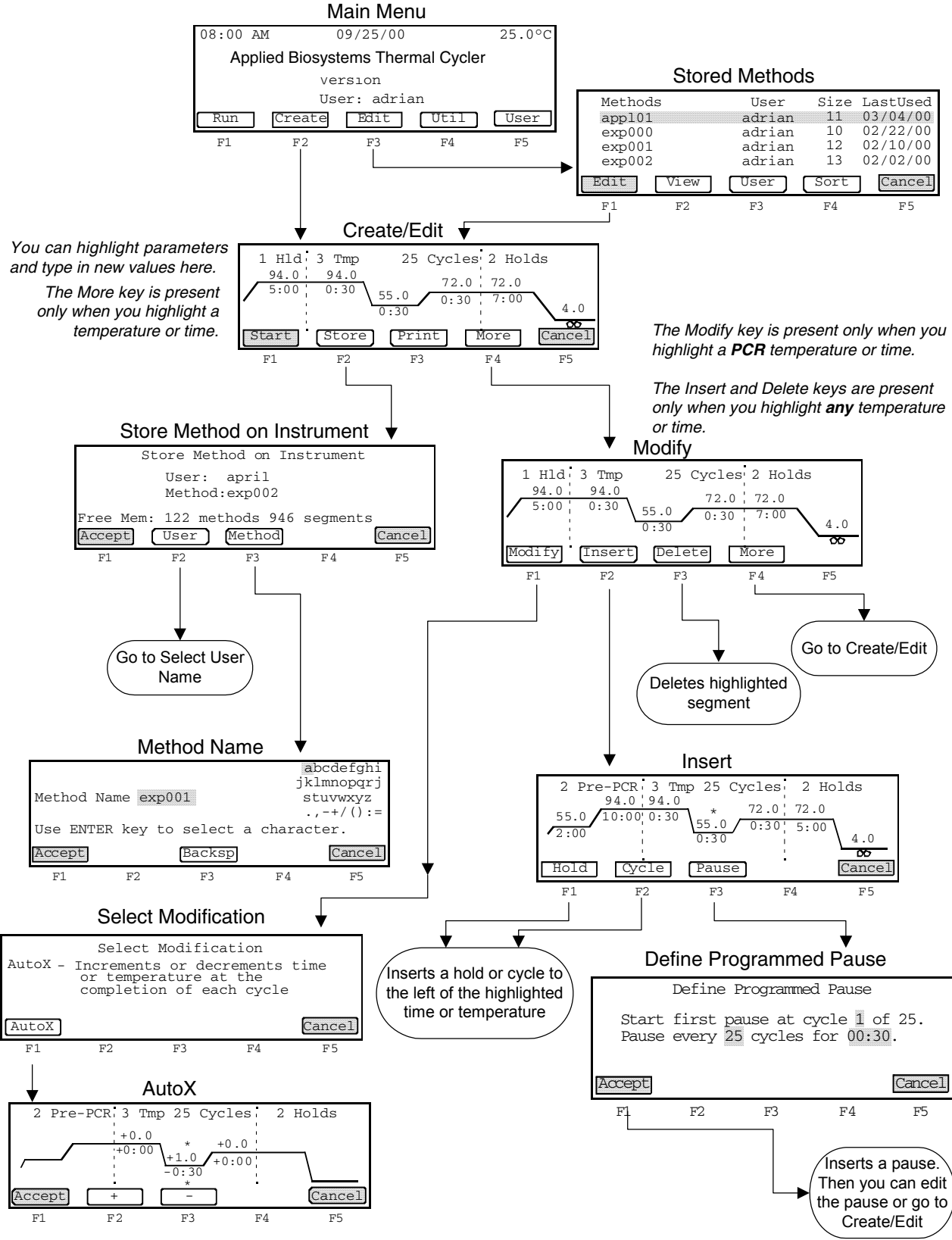

User

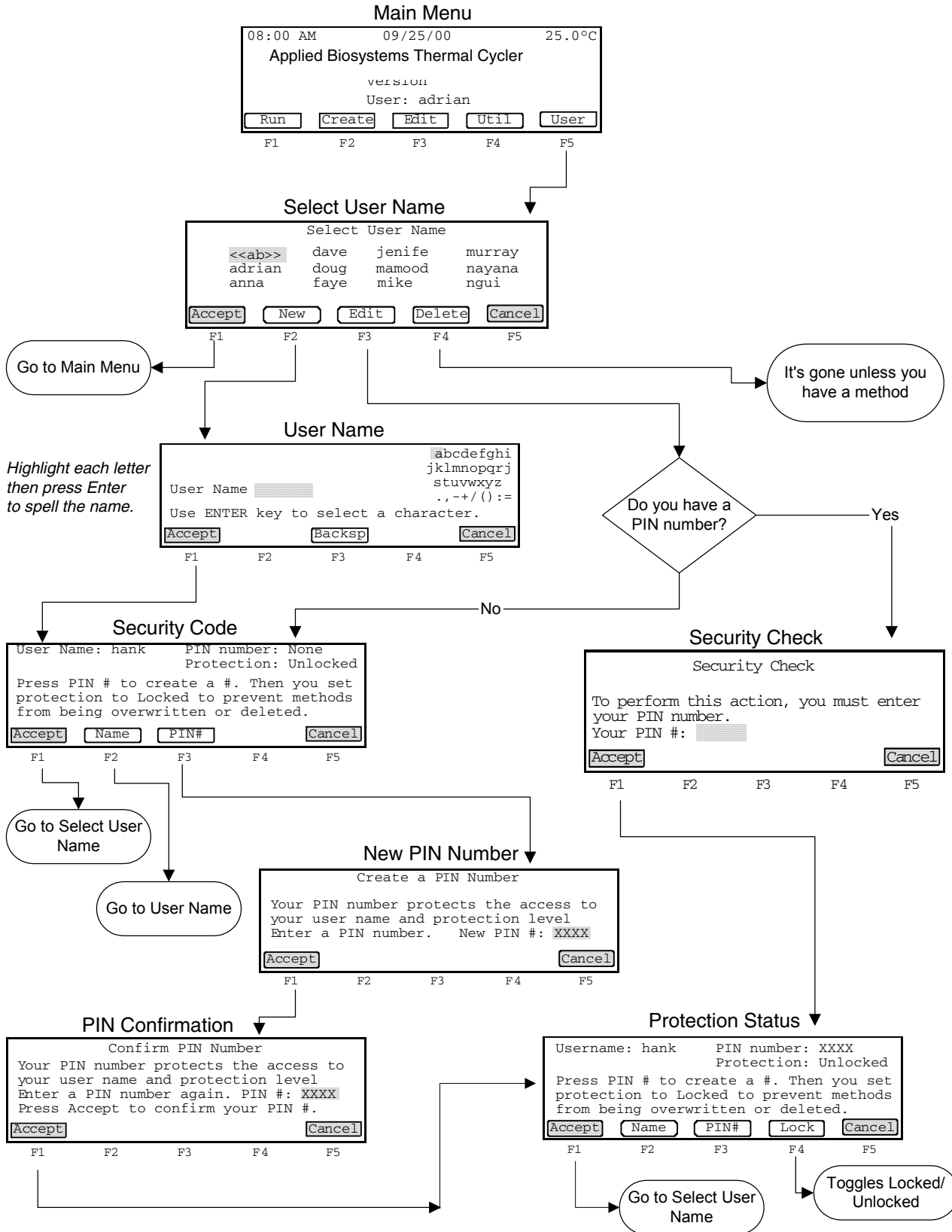

Utilities

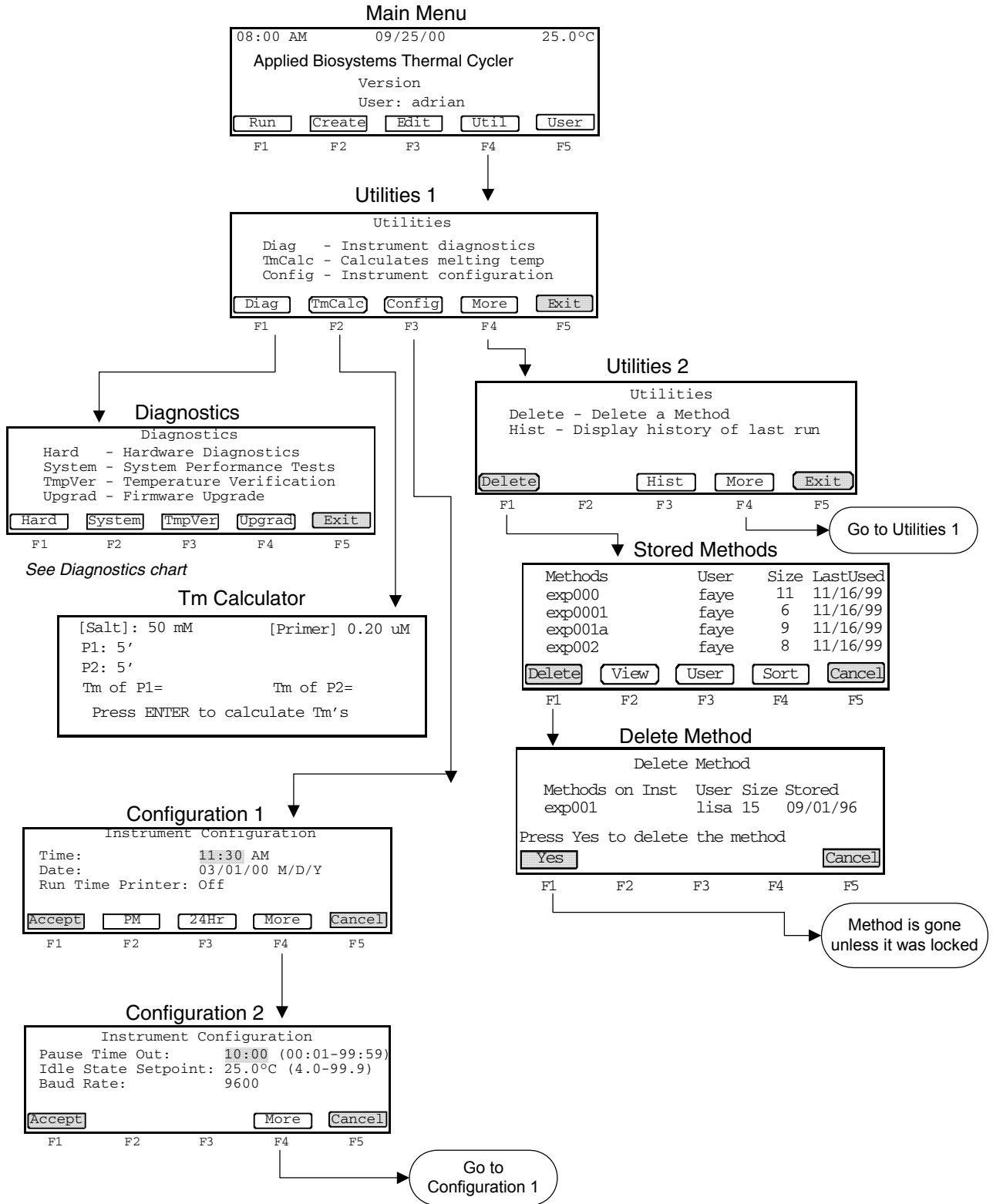

Diagnostics

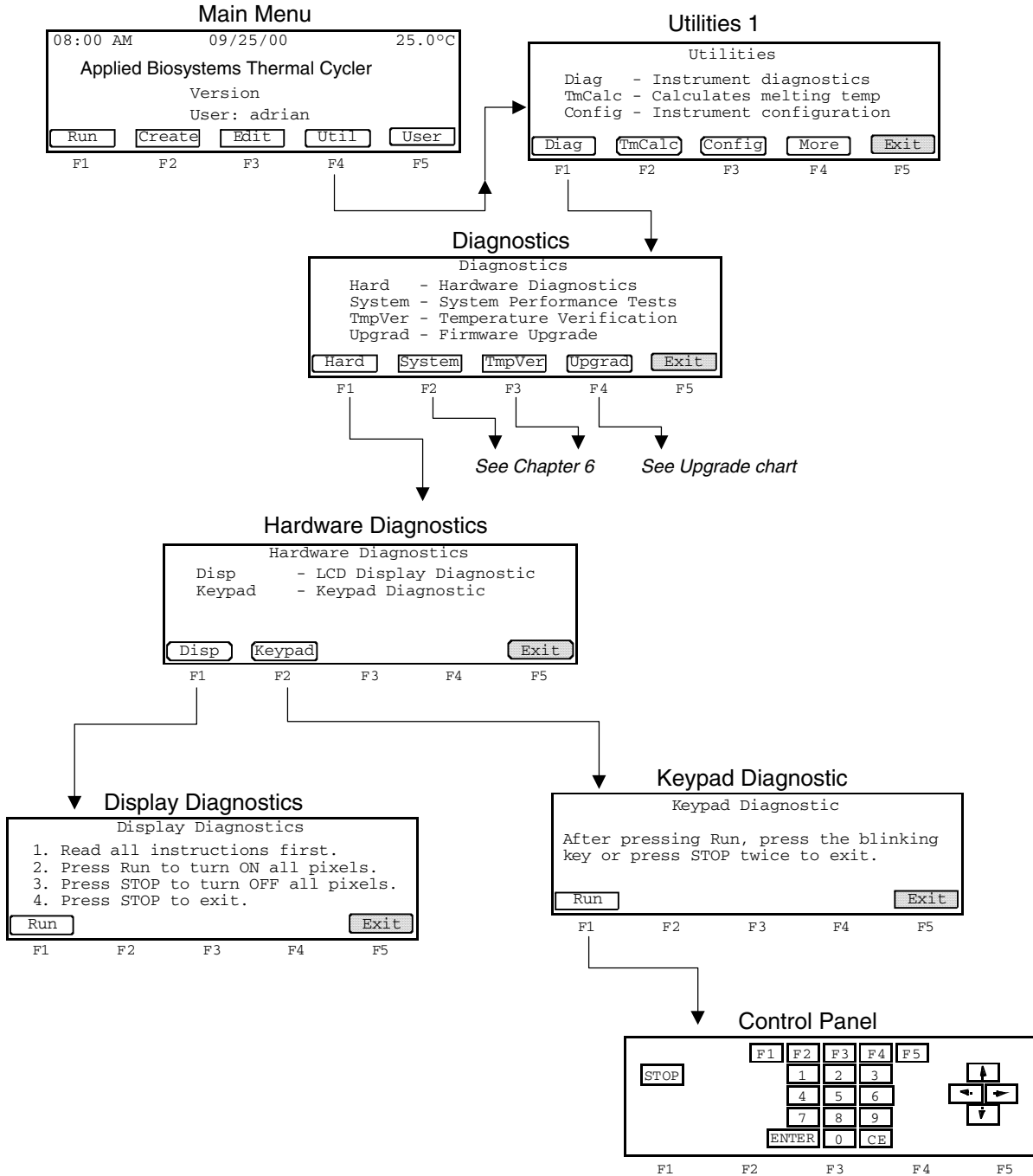

Upgrade

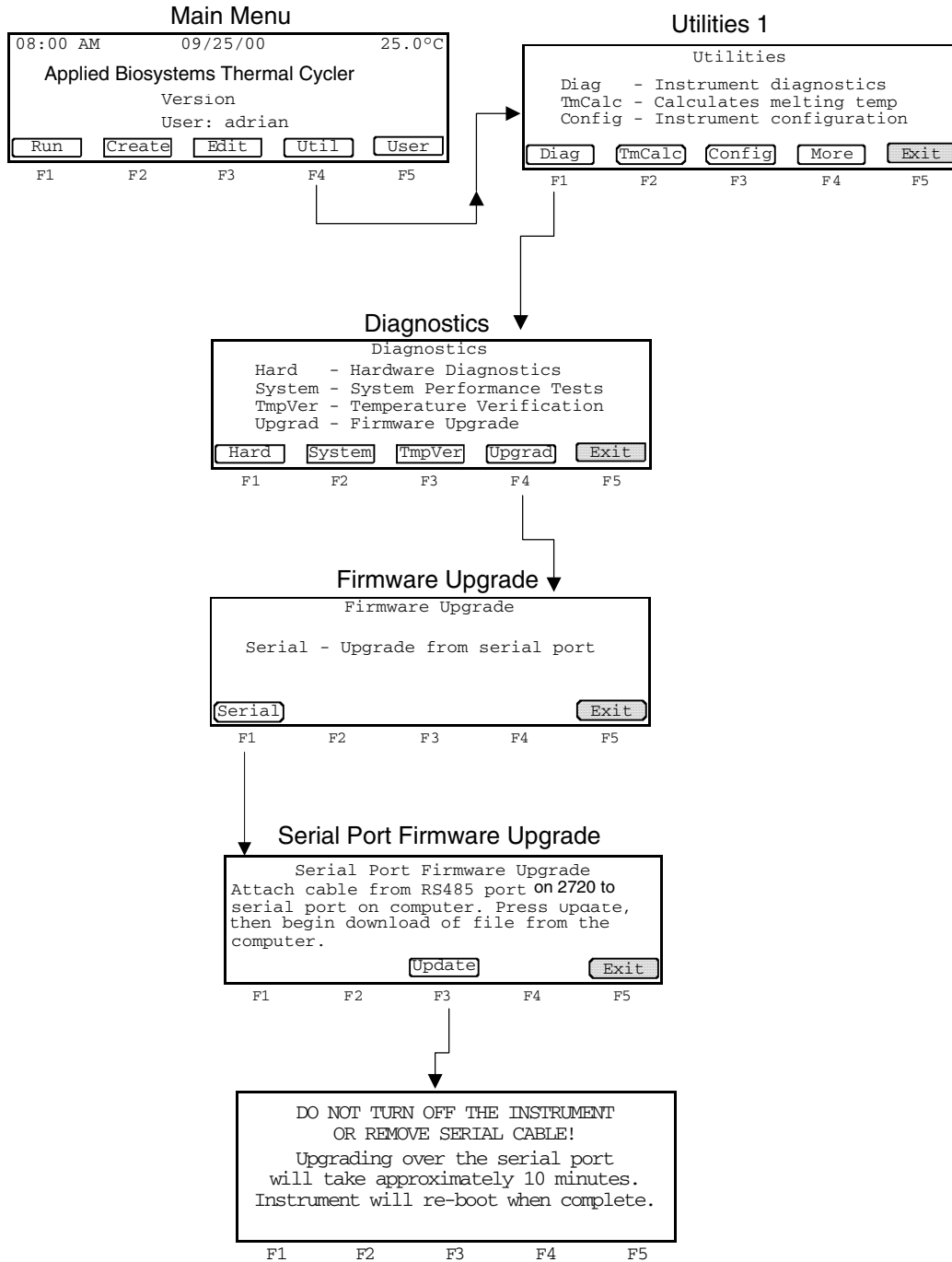

Instrument Warranty Information

D

Overview

About This Appendix This appendix provides information about the following: Computer Configuration, Limited Product Warranty, and Damages, Claims, and Returns.

Computer Configuration

Applied Biosystems supplies or recommends certain configurations of computer hardware, software, and peripherals for use with its instrumentation. Applied Biosystems reserves the right to decline support for or impose extra charges for supporting nonstandard computer configurations or components that have not been supplied or recommended by Applied Biosystems. Applied Biosystems also reserves the right to require that computer hardware and software be restored to the standard configuration prior to providing service or technical support. For systems that have built-in computers or processing units, installing unauthorized hardware or software may void the Warranty or Service Plan.

Limited Product Warranty

Limited Warranty Applied Biosystems warrants that all standard components of the GeneAmp® PCR Instrument Systems and Veriti® Thermal Cyclers will be free of defects in materials and workmanship for a period of one (1) year from the date the warranty period begins, unless otherwise stated. Applied Biosystems will repair or replace, at its discretion, all defective components during this warranty period. After this warranty period, repairs and replacement components may be purchased from Applied Biosystems at its published rates. Applied Biosystems also provides service agreements for post-warranty coverage. Applied Biosystems reserves the right to use new, repaired, or refurbished instruments or components for warranty and post-warranty service agreement replacements. Repair or replacement of products or components that are under warranty does not extend the original warranty period.

Applied Biosystems warrants that all optional accessories supplied with its GeneAmp® PCR Instrument Systems and Veriti® Thermal Cyclers, such as peripherals, printers, and special monitors, will be free of defects in materials and workmanship for a period of ninety (90) days from the date the warranty begins. Applied Biosystems will repair or replace, at its discretion, defective accessories during this warranty period. After this warranty period, Applied Biosystems will pass on to the buyer, to the extent that it is permitted to do so, the warranty of the original manufacturer for such accessories.

With the exception of consumable and maintenance items, replaceable products or components used on or in the instrument are themselves warranted to be free of defects in materials and workmanship for a period of ninety (90) days.

Applied Biosystems warrants that chemicals and other consumable products will be free of defects in materials and workmanship when received by the buyer, but not thereafter, unless otherwise specified in documentation accompanying the product. Applied Biosystems warrants that for a period of ninety (90) days from the date the warranty period begins, the tapes, diskettes, or other media bearing the operating software of the product, if any, will be free of defects in materials and workmanship under normal use. If there is a defect in the media covered by the above warranty and the media is returned to Applied Biosystems within the ninety (90) day warranty period, Applied Biosystems will replace the defective media.

Applied Biosystems does not warrant that the operation of the instrument or its operating software will be uninterrupted or error free

Warranty Period Effective Date	Any applicable warranty period under these sections begins on the earlier of the date of installation or ninety (90) days from the date of shipment for hardware and software installed by Applied Biosystems personnel. For all hardware and software installed by the buyer or anyone other than Applied Biosystems, and for all other products, the applicable warranty period begins the date the product is delivered to the buyer.
Warranty Claims	Warranty claims must be made within the applicable warranty period, or, for chemicals or other consumable products, within thirty (30) days after receipt by the buyer.
Warranty Exceptions	<p>THE ABOVE WARRANTIES DO NOT APPLY TO DEFECTS RESULTING FROM MISUSE, NEGLIGENCE, OR ACCIDENT, INCLUDING WITHOUT LIMITATION: OPERATION WITH INCOMPATIBLE SOLVENTS OR SAMPLES IN THE SYSTEM; OPERATION OUTSIDE OF THE ENVIRONMENTAL OR USE SPECIFICATIONS OR NOT IN CONFORMANCE WITH THE INSTRUCTIONS FOR THE INSTRUMENT SYSTEM, SOFTWARE, OR ACCESSORIES; IMPROPER OR INADEQUATE MAINTENANCE BY THE USER; INSTALLATION OF SOFTWARE OR INTERFACING, OR USE IN COMBINATION WITH SOFTWARE OR PRODUCTS, NOT SUPPLIED OR AUTHORIZED BY APPLIED BIOSYSTEMS; AND MODIFICATION OR REPAIR OF THE PRODUCT NOT AUTHORIZED BY APPLIED BIOSYSTEMS.</p> <p>THE FOREGOING PROVISIONS SET FORTH APPLIED BIOSYSTEMS' SOLE AND EXCLUSIVE REPRESENTATIONS, WARRANTIES, AND OBLIGATIONS WITH RESPECT TO ITS PRODUCTS, AND APPLIED BIOSYSTEMS MAKES NO OTHER WARRANTY OF ANY KIND WHATSOEVER, EXPRESSED OR IMPLIED, INCLUDING WITHOUT LIMITATION, WARRANTIES OF MERCHANTABILITY AND FITNESS FOR A PARTICULAR PURPOSE, WHETHER ARISING FROM A STATUTE OR OTHERWISE IN LAW OR FROM A COURSE OF DEALING OR USAGE OF TRADE, ALL OF WHICH ARE EXPRESSLY DISCLAIMED.</p>
Warranty Limitations	THE REMEDIES PROVIDED HEREIN ARE THE BUYER'S SOLE AND EXCLUSIVE REMEDIES. WITHOUT LIMITING THE GENERALITY OF THE FOREGOING, IN NO EVENT SHALL APPLIED BIOSYSTEMS BE LIABLE, WHETHER IN CONTRACT, TORT, WARRANTY, OR UNDER ANY STATUTE (INCLUDING WITHOUT LIMITATION, ANY TRADE PRACTICE, UNFAIR COMPETITION, OR OTHER STATUTE OF SIMILAR IMPORT) OR ON ANY OTHER BASIS, FOR DIRECT, INDIRECT, PUNITIVE, INCIDENTAL, MULTIPLE, CONSEQUENTIAL, OR SPECIAL DAMAGES SUSTAINED BY THE BUYER OR ANY OTHER PERSON OR ENTITY, WHETHER OR NOT FORESEEABLE AND WHETHER OR NOT APPLIED BIOSYSTEMS IS ADVISED OF THE POSSIBILITY OF SUCH DAMAGES, INCLUDING WITHOUT LIMITATION, DAMAGES ARISING FROM OR RELATED TO LOSS OF USE, LOSS OF DATA, FAILURE OR INTERRUPTION IN THE OPERATION OF ANY EQUIPMENT OR SOFTWARE, DELAY IN REPAIR OR REPLACEMENT, OR FOR LOSS OF REVENUE OR PROFITS, LOSS OF GOOD WILL, LOSS OF BUSINESS, OR OTHER FINANCIAL LOSS OR PERSONAL INJURY OR PROPERTY DAMAGE. NO AGENT, EMPLOYEE, OR REPRESENTATIVE OF APPLIED BIOSYSTEMS HAS ANY AUTHORITY TO MODIFY THE TERMS OF THIS LIMITED WARRANTY STATEMENT OR TO BIND APPLIED BIOSYSTEMS TO ANY AFFIRMATION, REPRESENTATION, OR WARRANTY CONCERNING THE PRODUCT THAT IS NOT CONTAINED IN THIS LIMITED WARRANTY STATEMENT, AND ANY SUCH MODIFICATION, AFFIRMATION, REPRESENTATION, OR WARRANTY MADE BY ANY AGENT, EMPLOYEE, OR REPRESENTATIVE OF APPLIED BIOSYSTEMS WILL NOT BE BINDING ON APPLIED BIOSYSTEMS, UNLESS IN A WRITING SIGNED BY AN EXECUTIVE OFFICER OF APPLIED BIOSYSTEMS.

THIS WARRANTY IS LIMITED TO THE BUYER OF THE PRODUCT FROM APPLIED BIOSYSTEMS AND IS NOT TRANSFERABLE.

Some countries or jurisdictions limit the scope of or preclude limitations or exclusion of warranties, of liability, such as liability for gross negligence or willful misconduct, or of remedies or damages, as or to the extent set forth above. In such countries and jurisdictions, the limitation or exclusion of warranties, liability, remedies or damages set forth above shall apply to the fullest extent permitted by law, and shall not apply to the extent prohibited by law.

Damages, Claims, and Returns

Damages If shipping damage to the product is discovered, contact the shipping carrier and request inspection by a local agent. Secure a written report of the findings to support any claim. Do not return damaged goods to Applied Biosystems without first securing an inspection report and contacting Applied Biosystems Technical Support for a Return Authorization (RA) number.

Claims After a damage inspection report is received by Applied Biosystems, Applied Biosystems will process the claim unless other instructions are provided.

Returns Do not return any material without prior notification and authorization.

If for any reason it becomes necessary to return material to Applied Biosystems, contact Applied Biosystems Technical Support or your nearest Applied Biosystems subsidiary or distributor for a return authorization (RA) number and forwarding address. Place the RA number in a prominent location on the outside of the shipping container, and return the material to the address designated by the Applied Biosystems representative.

Index

A

AmpliQaq Gold, about supplied method B-2
Applied Biosystems
 contacting viii
 customer feedback on documentation viii
 Information Development department viii
 Technical Support viii
AutoX function 4-16 to 4-17

B

baud rate 5-3
BigDye Terminator, about supplied method B-3
biohazardous waste, handling xvii
bold text, when to use vii

C

calibration verification test 5-9
CAUTION, description X
CE key 1-4
chemical safety XV, xvi
chemical waste safety xvii
claims, processing D-4
cleaning instrument 6-2 to 6-3
compressed gases, safety. See also pressurized
 fluids, safety XX
computer
 configuration requirement D-2
 technical support for altered configuration D-2
configuring instrument 5-2 to 5-3
control panel 1-4
conventions
 bold text vii
 for describing menu commands vii
 IMPORTANT! vii
 in this guide vii
 italic text vii
 Notes vii
 safety X
 user attention words vii
create/edit
 flowchart of screens C-4
 screen 4-6
 screen, described 1-6
customer feedback, on Applied Biosystems
 documents viii
cycle test 5-11 to 5-12
cycle, inserting 4-12 to 4-13

D

damage, reporting D-4
damaged items, returning D-4
DANGER, description X
date, configuring 5-3

diagnostics
 flowchart of screens C-7
 hardware 5-7 to 5-8
dimensions A-2
display
 overview 1-4
 specifications A-2
 testing 5-7
disposables 3-2 to 3-4
documentation, related viii

E

ELECTRICAL xviii
electrical safety xviii
electromagnetic compatibility standards. See EMC
 standards
EMC standards xxi
end of run
 flowchart of screens C-3
 screen 3-13
enter key 1-4
error messages 7-3 to 7-5

F

features 1-5, 2-10
field, selecting 1-4
fire hazard XIX
firmware, upgrading 5-4
flowcharts C-1 to C-8
function keys 1-4
fuses
 replacing 6-4 to 6-6

G

GeneAmp PCR System 2700
 overview 1-2 to 1-3
General PCR, about supplied method B-3
guidelines
 chemical safety xvi
 chemical waste disposal xvii
 chemical waste safety xvii

H

hardware diagnostics 5-7 to 5-8
hazard icons. See safety symbols, on instruments
hazard symbols. See safety symbols, on instruments
hazards. See safety
heated cover, cleaning 6-3
history file 3-11 to 3-12
hold
 deleting 4-11 to 4-12
 inserting 4-10 to 4-11

I

idle state setpoint 5-3
IMPORTANT, description X
Information Development department, contacting viii
installation category xviii
instrument operation, safety XV
Internet address
 Applied Biosystems 5-4
italic text, when to use vii

K

keypad 1-4
 testing 5-8

M

main menu 1-5
maintenance, routine 6-1 to 6-3
melting temperature 5-6
menu commands, conventions for describing vii
method
 creating 2-5 to 2-6, 4-6 to 4-8
 defined 1-6, 4-6
 deleting 4-22 to 4-23
 editing 2-7, 4-9
 locked 4-2 to 4-4
 printing 4-22
 protecting 2-10, 4-2 to 4-4
 searching for 4-21
 selecting 4-19
 sorting 4-20 to 4-21
 supplied B-2 to B-4
 viewing parameters 4-20
method not stored screen 3-13
MicroAmp disposables 3-2 to 3-4
moving parts, safety XX
MSDSs
 description xvi
 obtaining xvi
MSDSs, obtaining viii

N

numbers, entering 1-4

O

overvoltage category (rating) xviii

P

pause time out 5-3
pause, programmed
 deleting 4-16
 editing 4-15
 inserting 4-14 to 4-15
PCR segment 1-6
physical hazard safety XX
PIN number 4-2 to 4-5
post-PCR

parameters 4-8

segment 1-6

power failure 7-2

power on 2-2

printer

 connecting to 5-5

 run time 5-3

R

RA number D-4

RA number. *See* return authorization number

radioactive waste, handling xvii

rate test 5-10 to 5-11

reaction tubes 3-2 to 3-4

reporting, damages D-4

restart function 7-2

return authorization (RA) number D-4

returning damaged items D-4

returns D-4

run 3-1 to 3-13

 flowchart of screens C-2

 history of 3-11 to 3-12

 pausing 3-9

 starting 2-8 to 2-9, 3-7 to 3-8

 stopping 2-8 to 2-9, 3-10

S

safety

 before operating the instrument XV

 chemical XV

 chemical waste xvii

 compressed gases XX

 conventions X

 electrical xviii

 guidelines xvi, xvii

 instrument operation XV

 moving and lifting instrument XV

 moving parts XX

 moving/lifting XV

 physical hazard XX

 standards XXI

safety labels, on instruments xii

safety standards XXI

safety symbols, on instruments xi

sample block, cleaning 6-2 to 6-3

sample tubes 3-2 to 3-4

samples

 loading 3-5 to 3-6

 removing 3-6

specifications A-2 to A-3

standards

 EMC XXI

 safety XXI

starting 2-1 to 2-11

stop key 1-4

stop, flowchart of screens C-3

symbols, safety xi

system 2700

functions 1-5
overview 1-2 to 1-3, 2-10 to 2-11

T

Technical Support, contacting viii
technical support, for computers with altered
configuration D-2
temperature
control 4-16 to 4-17
idle state setpoint 5-3
melting, calculating 5-6
specifications A-3
verification test 5-9
text conventions vii
Time Release PCR, about supplied method B-3
time, configuring 5-3
Tm calculator 5-6
Touchdown PCR, about supplied method B-4
training, information on viii
troubleshooting 7-1 to 7-6

U

upgrade, flowchart of screens C-8
user attention words, described vii
user name
adding 2-3 to 2-4, 4-2 to 4-4
changing 4-4 to 4-5
deleting 4-5
flowchart of screens C-5
utilities
flowchart of screens C-6
procedures 5-1 to 5-12

W

WARNING, description x
warranty
damages, claims, returns D-4
for computers with altered configuration D-2
limitations D-3
warranty claims D-3
warranty exceptions D-3
warranty period, effective date D-3
waste disposal, guidelines xvii
waste profiles, description xvii
WWW address
Applied Biosystems 5-4

Worldwide Sales and Support

Applied Biosystems vast distribution and service network, composed of highly trained support and applications personnel, reaches 150 countries on six continents. For sales office locations and technical support, please call our local office or refer to our Web site at www.appliedbiosystems.com.

Applied Biosystems is committed to providing the world's leading technology and information for life scientists.

Headquarters

850 Lincoln Centre Drive
Foster City, CA 94404 USA
Phone: +1 650.638.5800
Toll Free (In North America): +1 800.345.5224
Fax: +1 650.638.5884952.4716

11/2010