



Thermo Scientific

Heraeus Cryofuge 5500i

Instruction Manual

20057781-c

08 / 2014

Visit us online to register your warranty.
www.thermoscientific.com/labwarranty

© 2014 Thermo Fisher Scientific Inc. All rights reserved.

Delrin, TEFLON, and Viton are registered trademarks of DuPont. Noryl is a registered trademark of SABIC POLYCLEAR is a registered trademark of Hongye CO., Ltd. Hypaque is a registered trademark of Amersham Health As. RULON A and Tygon are registered trademarks of Saint-Gobain Performance Plastics. Alconox is a registered trademark of Alconox. Ficoll is a registered trademark of GE Healthcare. Haemo-Sol is a registered trademark of Haemo-Sol. Triton X-100 is a registered trademark of Sigma-Aldrich Co. LLC.

All other trademarks are the property of Thermo Fisher Scientific Inc. and its subsidiaries.

Thermo Electron LED GmbH
Robert-Bosch-Straße 1
D - 63505 Langenselbold
Germany

Thermo Fisher Scientific Inc. provides this document to its customers with a product purchase to use in the product operation. This document is copyright protected and any reproduction of the whole or any part of this document is strictly prohibited, except with the written authorization of Thermo Fisher Scientific Inc.

The contents of this document are subject to change without notice. All technical information in this document is for reference purposes only. System configurations and specifications in this document supersede all previous information received by the purchaser.

Thermo Fisher Scientific Inc. makes no representations that this document is complete, accurate or error-free and assumes no responsibility and will not be liable for any errors, omissions, damage or loss that might result from any use of this document, even if the information in the document is followed properly.

This document is not part of any sales contract between Thermo Fisher Scientific Inc. and a purchaser. This document shall in no way govern or modify any Terms and Conditions of Sale, which Terms and Conditions of Sale shall govern all conflicting information between the two documents.

Original instruction manual 20057780-c printed in 08 /2014.

Instruction manual 20057781-c is a translation of 20057780-c.



**KONFORMITÄTSERKLÄRUNG
DECLARATION OF CONFORMITY**

Name und Anschrift des Herstellers und des Bevollmächtigten
für die Zusammenstellung der relevanten technischen Unterlagen:
Name and address of the manufacturer and of the authorized
representative to compile the relevant technical documentation:

**Thermo Electron LED GmbH
Werk Osterode
Am Kalkberg
D-37520 Osterode am Harz**

*Hiermit erklären wir, dass die nachstehend beschriebene Maschine
Herewith we declare, that the machinery described below*

Beschreibung /description	: Labor-Zentrifuge
Modellbezeichnung / model name	: Cryofuge 5500i
Modellnr/ model no.	: 75004471
Gültig ab Equipmentnr. Valid from equipment no.	: 41318912

*mit allen einschlägigen Bestimmungen der Maschinenrichtlinie 2006/42/EG in Übereinstimmung ist.
is in conformity with all relevant terms of directive for machinery 2006/42/EC.*

*Die Maschine ist auch in Übereinstimmung mit allen einschlägigen Bestimmungen der Richtlinie
2004/108/EG über elektromagnetische Verträglichkeit.
The machinery is in accordance with all relevant terms of directives for electromagnetic compatibility
2004/108/EC.*

*Die Schutzziele der Niederspannungsrichtlinie 2006/95/EG werden eingehalten.
The protection goals of the directive for low voltage 2006/95/EC are met.*

Angewandte harmonisierte Normen/
Harmonized standards used:

- EN 61010-1: 2004**
- EN 61010-2-020: 2006**
- EN 61326-1: 2006**
- EN 55011B: 2007**

Osterode, den 17.01.2012

Dr. Andreas Karl
Director R&D

Ort, Datum, Name, Funktion und Unterschrift /
Place, date, name, function and signature

	Name	Datum	Dokument	Revision
Erstellt	Lienemann	17.01.2012	79704471_03	03
Freigegeben	Laaboubi	17.01.2012		

WEEE Conformity

This product is subject to the regulations of the EU Waste Electrical & Electronic Equipment (WEEE) Directive 2002/96. It is marked by the following symbol:



Thermo Fisher Scientific has entered into agreements with recycling and disposal companies in all EU Member States for the recycling and disposal of this device. For information on recycling and disposal companies in Germany and on the products of Thermo Fisher Scientific, which fall under the RoHS Directive (Restriction of the use of certain hazardous substances in electrical and electronic equipment), please visit the website www.thermo.com/WEEERoHS

Table of Contents

	Preface	iii
	Scope of Supply	iii
	Intended Use	iv
	Accident Prevention	iv
	Precautions	iv
Chapter 1	Introduction and Description	1-1
	Characteristics of the Cryofuge 5500i	1-2
	Technical Data	1-3
	Directives, Standards and Guidelines	1-4
	Functions and Features	1-4
	Mains Supply	1-5
	Rotor Selection	1-6
Chapter 2	Before Use	2-1
	Before Setting up	2-2
	Setting up	2-2
	Aligning the Centrifuge	2-4
	Transporting the Centrifuge	2-4
	Location	2-4
	Mains Connection	2-5
	Adjust Voltage and Frequency	2-6
	Storage	2-6
Chapter 3	Control Panel	3-1
	Control Panel	3-2
	Keys	3-2
Chapter 4	Operation	4-1
	Switch on Centrifuge	4-2
	Centrifuge Door	4-2
	Rotor Installation	4-3
	Entering Parameters	4-4
	Centrifugation	4-8
	Temperature Adaptation during Standstill	4-9
	Short-term Centrifugation	4-9
	Removing the Rotor	4-9
	Aligning the Centrifuge	4-10
	Audible Alarm	4-10
	Key Switch	4-11

Chapter 5	Maintenance and Care	5-1
	Cleaning Intervals	5-2
	Cleaning	5-2
	Cleaning the Venting Slots	5-3
	Disinfection	5-3
	Decontamination	5-4
	Service of Thermo Fisher Scientific	5-5
Chapter 6	Troubleshooting	6-1
	Mechanical Emergency Door Release	6-2
	Troubleshooting by User	6-3
	When to contact a Service Technician	6-5

Preface

Before starting to use the centrifuge, read through this instruction manual carefully and follow the instructions.

The information contained in this instruction manual is the property of Thermo Fisher Scientific; it is forbidden to copy or pass on this information without explicit approval.

Failure to follow the instructions and safety information in this instruction manual will result in the expiration of the sellers warranty.

Scope of Supply

Article Number		Quantity	Check
	Centrifuge Cryofuge 5500i	1	<input type="checkbox"/>
	Power supply cable	1	<input type="checkbox"/>
50127698	CD with manual	1	<input type="checkbox"/>

If any parts are missing, please contact your nearest Thermo Fisher Scientific representative.



This symbol refers to general hazards.

CAUTION means that material damage could occur.

WARNING means that injuries or material damage or contamination could occur.



This symbol refers to biological hazards.

Observe the information contained in the instruction manual to keep yourself and your environment safe.

Intended Use

- This centrifuge is a laboratory product designed to separate components by generation of a relative centrifugal force. It separates human samples (e.g. blood, urine and other body fluids) collected in appropriate containers, either alone or after addition of reagents or other additives.
- Laboratory centrifuge for the application in large laboratories, blood banks, and other the sector of the pharmaceutical and bio-technological industry.
- The centrifuge is to be used for separating materials of different density or particle size suspended in a liquid.
Maximum sample density at maximum speed: $1.2 \frac{g}{cm^3}$

Accident Prevention

Prerequisite for the safe operation of the Heraeus Cryofuge 5500i is a work environment in compliance with standards, directives and trade association safety regulations and proper instruction of the user.



The safety regulations contain the following basic recommendations:

- Maintain a radius of at least 30cm around the centrifuge.
- Implementation of special measures which ensure that no one can approach the centrifuge for longer than absolutely necessary while it is running.
- The mains plug must be freely accessible at all times. Pull out the power supply plug or disconnect the power supply in an emergency.

Precautions



In order to ensure safe operation of the Cryofuge 5500i, the following general safety regulations must be followed:

- The centrifuge should be operated by trained specialists only.
- The centrifuge is to be used for its intended use only.



- Plug the centrifuge only into sockets which have been properly grounded.
- Do not move the centrifuge while it is running.
- Do not lean on the centrifuge.
- Use only rotors and accessories for this centrifuge which have been approved by Thermo Fisher Scientific. Exceptions to this rule are commercially available glass or plastic centrifuge tubes, provided they have been approved for the speed or the RCF value of the rotor.
- Do not use rotors which show any signs of corrosion and/or cracks.
- Do not touch the mechanical components of the rotor and do not make any changes to the mechanical components.
- Use only with rotors which have been properly installed. Follow the instructions in section “Rotor Installation” on page 4-3.
- Use only with rotors which have been loaded properly. Follow the instructions given in the rotor manual.
- Never overload the rotor. Follow the instructions given in the rotor manual.
- Never open the lid until the rotor has come to a complete stop and this has been confirmed in the display.
- The lid emergency release may be used in emergencies only to recover the samples from the centrifuge, e.g. during a power failure (see section “Mechanical Emergency Door Release” on page 6-2).
- The performance of the gas springs might diminish after some time. Check the gas springs as described in “Centrifuge Door” on page 4-2.
- Never use the centrifuge if parts of its cover panels are damaged or missing.
- Do not touch the electronic components of the centrifuge or alter any electronic or mechanical components.
- Please observe the safety instructions.

Please pay particular attention to the following aspects:

- Location: well-ventilated environment, set-up on a level and rigid surface with adequate load-bearing capacity.
- Rotor installation: make sure the rotor is locked properly into place before operating the centrifuge.
- Especially when working with corrosive samples (salt solutions, acids, bases), the accessory parts and vessel have to be cleaned carefully.
- Always balance the samples.

Centrifuging hazardous substances:

- Do not centrifuge explosive or flammable materials or substances which could react violently with one another.
- The centrifuge is neither inert nor protected against explosion. Never use the centrifuge in an explosion-prone environment.
- Do not centrifuge inflammable substances.
Remaining risk: Improper use can cause damages, contamination, and injuries with fatal consequences.



- Do not centrifuge toxic or radioactive materials or any pathogenic micro-organisms without suitable safety precautions.

When centrifuging microbiological samples from the Risk Group II (according to the Bio-safety Manual" of the World Health Organization (WHO)), aerosol-tight biological seals have to be used.

For materials in a higher risk group, extra safety measures have to be taken.

- If toxins or pathogenic substances have gotten into the centrifuge or its parts, appropriate disinfection measures have to be taken (see "Disinfection" on page 5-3).
Remaining risk: Improper use can cause damages, contamination, and injuries with fatal consequences.
- Highly corrosive substances which can cause material damage and impair the mechanical stability of the rotor, should only be centrifuged in corresponding protective tubes.



WARNING

If a hazardous situation occurs, turn off the power supply to the centrifuge and leave the area immediately.

Introduction and Description

Contents

- “Characteristics of the Cryofuge 5500i” on page 1-2
- “Technical Data” on page 1-3
- “Directives, Standards and Guidelines” on page 1-4
- “Functions and Features” on page 1-4
- “Mains Supply” on page 1-5
- “Rotor Selection” on page 1-6

Characteristics of the Cryofuge 5500i

The Cryofuge 5500i is a large volume, refrigerated universal centrifuge.

The Cryofuge 5500i is designed for large volume, high throughput laboratory needs. The micro test plates and tubes can be centrifuged with the unique double rectangular bucket.

The Cryofuge 5500i is optimized for the automatic laboratory processes in clinical central labs.

The Diagnostik™ rotor allows the centrifuge commercial sample racks directly.

The Cryofuge 5500i is also a compact centrifuge for the separation of blood components. A special wind shield rotor allows to process up to eight quintuple blood bag systems.

The Cryofuge 5500i is equipped with various safety features:

- The housing and rotor chamber consist of steel plate, the interior of armor steel, while the front panel is made of high-impact resistant plastic.
- The door is equipped with a view port and a lock.
- The door of the centrifuge can only be opened while the centrifuge is switched on and the rotor has come to a complete stop. The centrifuge cannot be started until the door has been closed properly.
- The integrated rotor detection systems ensures that no inadmissible speed settings can be preselected.
- Electronic imbalance detection, SMARTspin®.
- Door emergency release: For emergencies only, e.g. during power failures (see “[Mechanical Emergency Door Release](#)” on [page 6-2](#)).

Technical Data

The technical data of the Cryofuge 5500i is listed in the following table.

Table 1-1. Technical Data

Feature	Value		
	230 V	200 V	120 V
Environmental Conditions	-Use in interior spaces -Altitudes of up to 2,000 m above sea level -max. relative humidity 80% up to 31 °C; decreasing linearly up to 50% relative humidity at 40 °C.		
Permissible Ambient Temperature	+2 °C to +40 °C	+2 °C to +40 °C	+2 °C to +40 °C
Overvoltage Category	II	II	II
Pollution Degree	2	2	2
Heat Dissipation	9200 BTU/h	9200 BTU/h	6300 BTU/h
IP	20	20	20
Running Time	unlimited	unlimited	unlimited
Max Speed n_{max}	10000 rpm (depending on the rotor)	10000 rpm (depending on the rotor)	10000 rpm (depending on the rotor)
Min Speed n_{min}	300 rpm	300 rpm	300 rpm
Maximum RCF Value at n_{max}	15317 x g	15317 x g	15317 x g
Maximum Kinetic Energy	<63.4 kJ	<63.4 kJ	<63.4 kJ
Noise Level at maximum Speed	<61 dB(A)	<61 dB(A)	<61 dB(A)
Temperature Setting Range	-9 °C to +40 °C	-9 °C to +40 °C	-9 °C to +40 °C
Dimensions			
Height	960 mm	960 mm	960 mm
Width	680 mm	680 mm	680 mm
Depth	720 mm	720 mm	720 mm
Weight without Rotor	286 kg	286 kg	286 kg

Directives, Standards and Guidelines

Table 1-2. Directives, Standards and Guidelines







Tension / Frequency		Produced and inspected according to the following Standards and Guidelines
200 V / 50 Hz	2006/95/EC Low Voltage Directive:	EN 61010-1, 2 nd Edition
230 V / 60 Hz	2006/42/EC Machine Directive:	EN 61010-2-020, 2 nd Edition
	2004/108/EC EMC Directive	EN 61326-1
		EN 55011B
		EN 61000-6-2
200-230 V / 60 Hz	cCSAus approved:	UL 61010-1, 2 nd Edition
120 V / 60 Hz	The centrifuges are produced and inspected according to the following standards and guidelines	CAN/CSA-C22.2 No. 61010-1, 2 nd Edition
		IEC 61010-2-20, 2 nd Edition
		(Pollution degree 2, Overvoltage category II)

Functions and Features

The following table gives an overview of the important functional and performance characteristics of the Cryofuge 5500i.

Table 1-3. Functions and Features

Component / Function	Description / Features
Structure / Housing	Galvanized Steel Chassis with Armored Plating
Rotor Chamber	Stainless Steel
Drive	Induction Drive without Carbon Brushes
Keys and Display	Easy-to-clean Keypad and Display Surface
Controls	Microprocessor controlled with Easycontrol II
Internal Memory	The most recent Data is saved
Functions	RCF-Selection, Temperature Regulation during Standstill, Pre-Temp, and PULSE
Acceleration / Braking Profiles	9 Acceleration and 9 Braking Curves
Rotor Recognition	Automatic
Imbalance Detection SMARTspin®	Electronic, contingent on Rotor and Speed
Door Lock	Motor assisted Door Locking

Function	Feature
Program Display	Free Program Selection  Operating Memory 1...9 Memory Capacity for Set Values  PULSE-Mode
Acceleration / Braking Profiles	1 = slow, ... 9 = fast Acceleration / Deceleration Curve
Speed Selection	Adjustable from 300rpm to 10,000rpm in 10rpm Increments
RCF Selection	After actuating the RCF Switch Key, the RCF Value can be entered.
Time Selection	Adjustable in Seconds up to 9 min 59sec, in the Range of 10 min up to 99 min in Minutes, "hold"-mode: Continuous Operation
Run Time Display in "quick run" Mode	In Seconds Increments
Temperature Selection	Adjustable from -9 °C to +40 °C, in 1°C Increments.
End of Run	The Speed Display will read End .
Door Opening	Automatic unlocking via Key  (unlocking in Case of Power Failure: see chapter "Troubleshooting")
Start	Key 
Stop	Key 
PULSE-Mode	Pressing the  Key activates maximum Acceleration up to the maximum permissible Speed of Rotor; upon Key release Centrifuge stops with maximum Deceleration Power.
Diagnostic Messages	Alternating Display rotor /maximum Speed or RCF (Speed selected exceeds max. Speed of the Rotor) Door has not been lifted off the Lock during Opening: Display Lift Lid (manual Lifting of door required) General Centrifuge malfunction (Error Messages with ERROR Codes, see "Troubleshooting by User" on page 6-3)

Mains Supply

The following table contains an overview of the electrical connection data for the Cryofuge 5500i. This data is to be taken into consideration when selecting the mains connection socket.

Table 1-4. Electrical Connection Data

Cat.	Mains Voltage	Frequency	Rated Current	Power Consumption	Equipment Fuse	Building Fuse
7500 4471	230 V	50 Hz	12 A	2.7 kW	16 AT	16 AT
7500 4475	120 V	60 Hz	16 A	1.9 kW	16 AT	20 AT
7500 4479	200-230 V	60 Hz	14.5 A	2.7 kW	16 AT	20 AT
7500 4479	200 V	50 Hz	14.5 A	2.7 kW	16 AT	20 AT

Rotor Selection

The Cryofuge 5500i is supplied without a rotor.

Various Thermo Scientific rotors are available to choose from.

LH-4000 ¹	7500 6475
with round Buckets 1000	7500 6477
Double rectangular Bucket DoubleSpin™ 2 x 250	7500 6478
LH-4000W	7500 6476
with round Buckets 1000	7500 6477
Double rectangular Bucket DoubleSpin™ 2 x 250	7500 6478
with double Blood Bag Bucket ²	7500 6436
BIOshield® 4 x 250	7500 6435
HIGHPlate® 5 x 5 Platten	7500 6444
Diagnostik™	7500 6480
HIGHConic® 6 x 50	7500 3057
LAC-250 6 x 250	7500 6483

¹This rotor is not available for the 120 V centrifuge.

²This rotor is not available for the 120 V centrifuge.

The technical data of the rotors and the corresponding adapters and reduction sleeves for various commercially available containers can be found in the corresponding rotor operating manuals.

For more information visit our website at: <http://www.thermo.com>

Before Use

Contents

- “Setting up” on page 2-2
- “Aligning the Centrifuge” on page 2-4
- “Transporting the Centrifuge” on page 2-4
- “Location” on page 2-4
- “Mains Connection” on page 2-5
- “Adjust Voltage and Frequency” on page 2-6
- “Before Setting up” on page 2-2
- “Storage” on page 2-6

Before Setting up

1. Check the centrifuge and the packaging for any shipping damage.
Inform the shipping company and Thermo Fisher Scientific immediately if any damage is discovered.
2. Remove the packaging.
3. Check the order for completeness (see “Scope of Supply” on page iii).
If the order is incomplete, please contact Thermo Fisher Scientific.

Setting up



WARNING The centrifuge operated with a high kinetic energy. Do not operate the centrifuge without a 30 cm (12 inch) safety zone around the centrifuge. Do not operate the centrifuge on its castors.

Note The centrifuge is screwed onto the pallet with four screws.

1. Place the pallet with the centrifuge so that you have at least 2 m room in front of the pallet.
2. Release the rails from the pallet.
3. Screw the rails onto the pallet in front of the centrifuge.

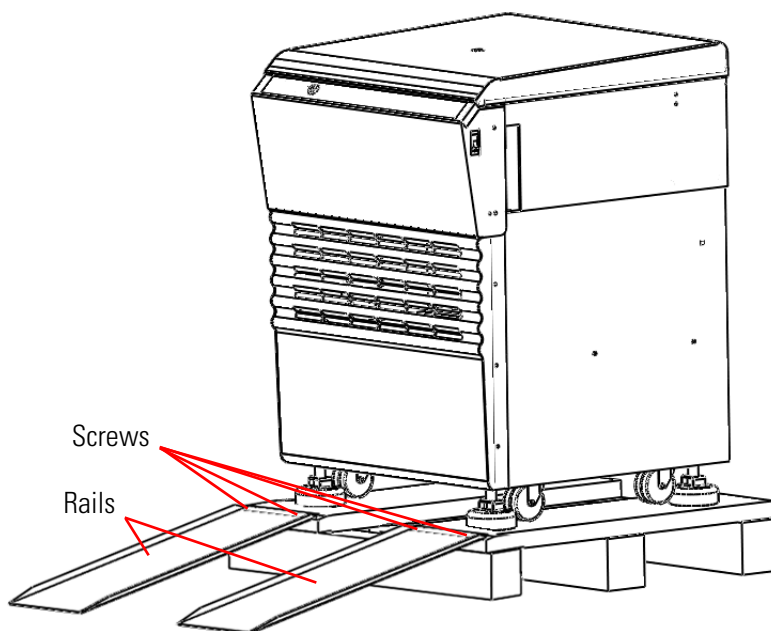

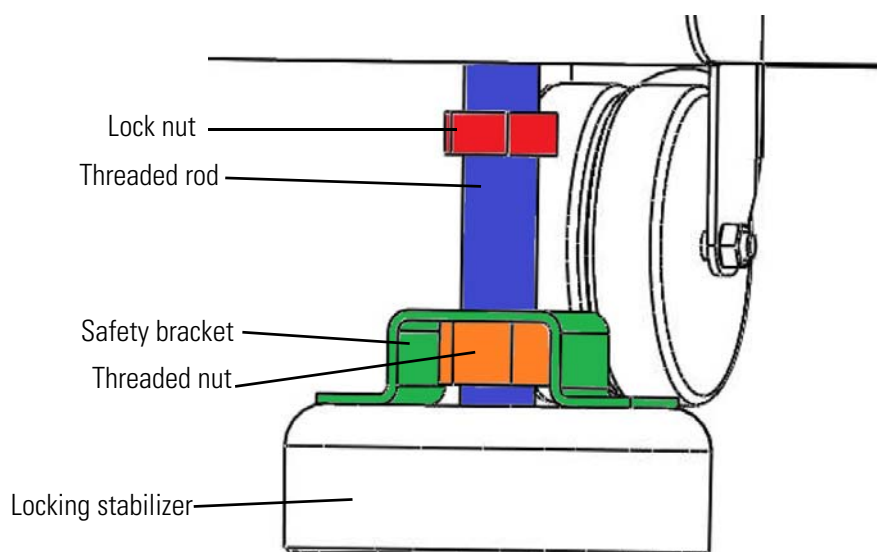

4. Screw the threaded rods with the threaded nuts as far up as possible. Otherwise they might get stuck when rolling the centrifuge off the pallet.
5. Remove the locking stabilizers.

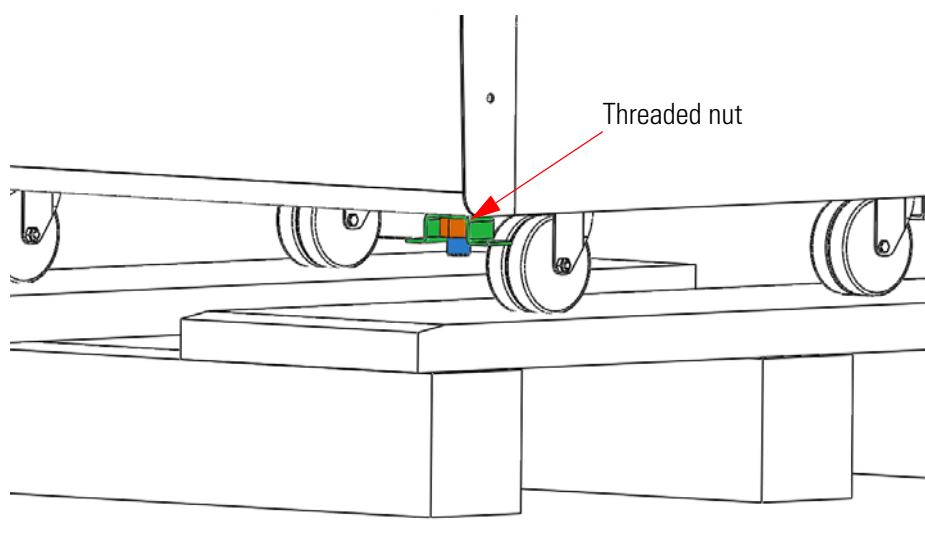

6. Check that the steering casters point to the back.
7. Use several people and other means in order to roll the centrifuge off the pallet.



WARNING Due to the centrifuges weight it must be controlled by several people when rolling of the pallet. Do not stand in front of the centrifuge when rolling down for the centrifuge might run you over.

8. Once the centrifuge is in its final position mount the enclosed locking stabilizers.
9. Screw the threaded nuts down.
10. Place the locking stabilizers centrally under the threaded rods and align the centrifuge. All the locking stabilizers should carry uniformly (check by a tilt test). The casters are some 5-15 mm off the ground.

Aligning the Centrifuge

11. Switch on the centrifuge.
12. Open the centrifuge.
13. Put the enclosed water level on the drive spindle.
14. Use an open-end wrench to align the centrifuge and to raise and lower it.



CAUTION If the centrifuge is not level, imbalances can occur and the centrifuge can be damaged.
The horizontal alignment of the centrifuge must be checked every time after moving it to a different location.
The supporting structure must be suitable for horizontal setup of the centrifuge.
Do not place anything under the feet to level the centrifuge.

15. Remove the water level when the centrifuge is leveled.
16. Be sure that the four locking stabilizers stand safe and do not jolt.
17. Fasten the lock nuts by screwing them up as far as possible.
18. Screw the safety bracket onto the locking stabilizers.
19. The final assembly of the safety brackets is carried out after leveling.

Transporting the Centrifuge

- Use a forklift to lift the centrifuge.
- The centrifuge can be damaged by impacts.
- Transport the centrifuge upright and if at all possible in packaging.

Note The packaging is an one-way packaging. Contact a shipping company for the transport. Inform customer service.



WARNING Always remove the rotor before moving the centrifuge.

Location

The centrifuge should only be operated indoors.

The set-up location must fulfill the following requirements:

- A safety zone of at least 30 cm must be maintained around the centrifuge. People and hazardous substances must be kept out of the safety zone while centrifuging.
- The supporting structure must be stable and free of resonance.
- The supporting structure must be suitable for horizontal setup of the centrifuge.

- The centrifuge should not be exposed to heat and strong sunlight.



WARNING UV rays reduce the stability of plastics.
Do not subject the centrifuge, rotors and plastic accessories to direct sunlight.

- The set-up location must be well-ventilated at all times.

Mains Connection

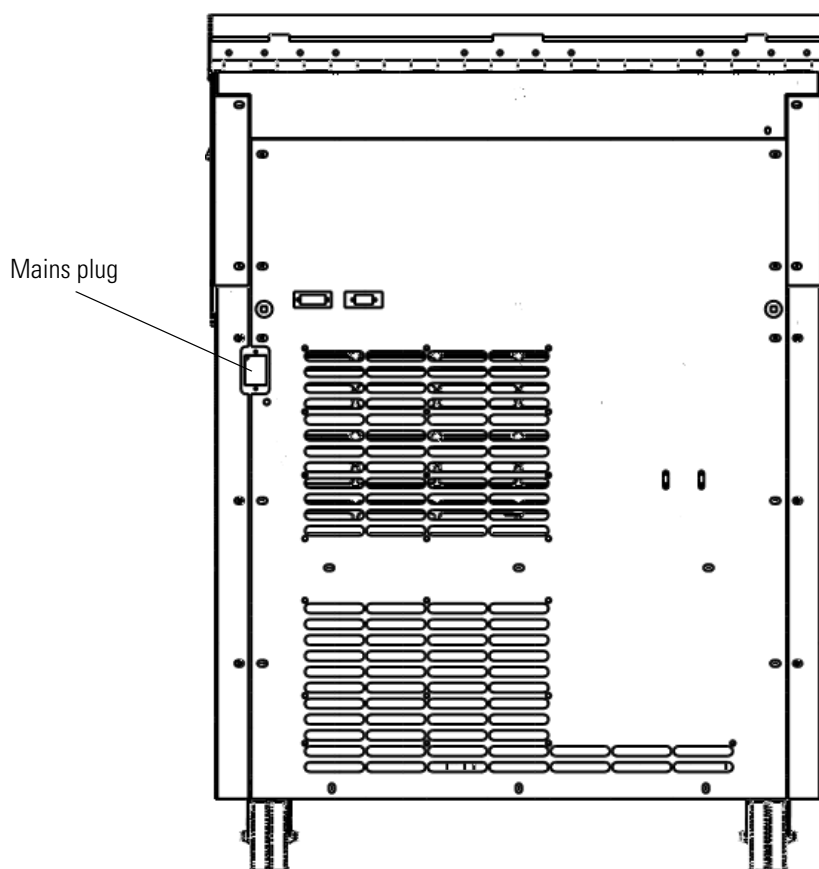

Figure 2-1. Mains Connection

1. Turn off the power supply switch located on right side (press "0").
2. Plug the centrifuge into grounded electrical sockets only.
3. Check whether the cable complies with the safety standards of your country.
4. Make sure that the voltage and frequency correspond to the figures on the rating plate.
5. Establish the connection to the power supply with the connecting cable.

Adjust Voltage and Frequency

It is necessary that you set the voltage and frequency during setup.

1. Pull out the power supply plug.



CAUTION Remove the power supply plug in order to prevent damage to the centrifuge.

2. Set the switches on the back as shown in the table.

Voltage /frequency setting					
voltage	frequency	current	power	S2	S3
208 V	60 Hz	15 A	2,8 kW	a	a
200 V	60 Hz	16 A	2,8 kW		
200 V	50 Hz	15 A	2,7 kW	b	a
230 V	60 Hz	13 A	2,8 kW	b	b

	a		a
Switch S2			Switch S3
	b		b

WARNING : Remove line plug before switching !

3. Connect the centrifuge to the power supply again.

Storage

- Before storing the centrifuge and the accessories it must be cleaned and if necessary disinfected and decontaminated.
- Store the centrifuge in a clean, dust-free location.
- Be sure to place the centrifuge on its feet.
- Avoid direct sunlight.

Control Panel

Contents

- “Control Panel” on page 3-2
- “Keys” on page 3-2





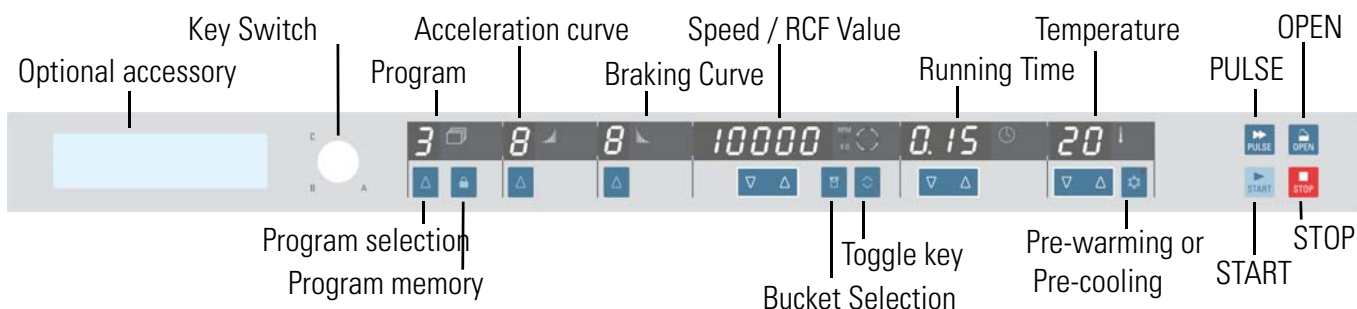











Control Panel

The control panel contains the keys and displays of the centrifuge (only the power switch is located on the right side of the device). All parameters can be selected and changed during operation.



Keys

The keys allow user intervention for controlling the operating mode as follows:

Key	Display contents
 Start	Normal start of the centrifuge.
 Stop	End run manually.
 Open Door	Automatic release (possible only when device is switched on); Emergency release (see "Mechanische Notentriegelung des Deckels" auf Seite 7-2).
 Pulse	By pressing the  key the centrifuge starts immediately and accelerates up to the end speed. Releasing the key initiates a stopping process at the highest braking curves.
 UP	By pressing the  key you change the value in the display.
 Bucket	Use the  key in order to have all available bucket types displayed in succession.
 Pre-Temp	By pressing the  key you start the pre-temp function of the centrifuge.
 Changing the Display Mode	Use the key  to change the display mode.
 SAVE	Press the  key to save a program.
	By pressing the  key up and down you change the value in the display. If you hold the key pressed, the display changes continuously at first slowly and after a few seconds at an accelerated pace to the higher or lower values. By pressing the key briefly, you increase or decrease the speed in one step. When pressing both arrows the cursor moves to the left.

Operation

Contents

- “Switch on Centrifuge” on page 4-2
- “Centrifuge Door” on page 4-2
- “Rotor Installation” on page 4-3
- “Entering Parameters” on page 4-4
- “Centrifugation” on page 4-8
- “Temperature Adaptation during Standstill” on page 4-9
- “Short-term Centrifugation” on page 4-9
- “Removing the Rotor” on page 4-9
- “Aligning the Centrifuge” on page 4-10

Switch on Centrifuge

1. Turn on the power switch on the right side of the device.
The centrifuge performs a self-check of its software. Subsequently, the following readings will be displayed. The display shows the values from the last run.

Centrifuge Door



WARNING The performance of the gas springs might diminish after some time. Do not place your hand in the door opening when the door is not totally open.

Check the gas springs as described below:

- Open the centrifuge approximately 10cm.
 - If the door remains in this position, the gas springs are working fine.
 - If the door moves downwards, the gas springs need to be replaced.

Door Opening

The door can only be opened when the centrifuge is turned on.

1. Press the  key.



WARNING Do not reach into the crack between the door and the housing. The door is drawn shut automatically.

Use the emergency release only for malfunctions and power failures (see “[Mechanical Emergency Door Release](#)” on [page 6-2](#)).

Close Door

2. Close the door by pressing down on it lightly in the middle or on both sides of it. Two locks close the door completely.

Note The door should audibly click into place.



WARNING Do not reach into the crack between the door and the housing. The door is drawn shut automatically.

Use the emergency release only for malfunctions and power failures (see “[Mechanical Emergency Door Release](#)” on [page 6-2](#)).



CAUTION Do not slam the door.

Rotor Installation

The approved rotors for the Cryofuge 5500i are listed in section “Rotor Selection” on page 1-6. Use only the rotors and accessories from this list in the centrifuge.



CAUTION Unapproved or incorrectly combined accessories can cause serious damage to the centrifuge.

Proceed as follows:

1. Open the door of the centrifuge and if necessary remove any dust, foreign objects or residue from the chamber.
Thread and o-ring must be clean and undamaged.
2. Hold the rotor over the centrifuge spindle.
3. Let the rotor slide slowly down the centrifuge spindle.



CAUTION Do not force the rotor onto the centrifuge spindle.

4. Thread the fastening tool into the centrifuge spindle clockwise. Hold the rotor with the other hand into position.
5. Check if the rotor is properly installed by lifting it slightly on the handle.



WARNING Check for any damage to the rotor: Damaged rotors must not be used. Keep the centrifuge spindle area of the rotor clear of objects.



CAUTION Check that the rotor is properly locked on the centrifuge spindle before each use by pulling it at its handle.

6. If available close the rotor with the rotor lid.



Be sure to check all sealings before starting any aerosol-tight applications. See the information in the rotor instruction manual.

7. Close the centrifuge door.

Entering Parameters

Acceleration Curve

The Cryofuge 5500i offers you a total of 9 acceleration and 9 braking curves with which samples and gradients can be centrifuged.

After the centrifuge is turned on, the last running profile selected is shown.

1. Press the  below the field acceleration profile to change the acceleration profile.
Curve number 1 is the slowest and curve number 9 the fastest.
2. The value is stored when the value stops flashing.



Braking Curve

1. Press the  below the field breaking curve to change the breaking curve.
Curve number 1 is the slowest and curve number 9 the fastest.
2. The value is stored when the value stops flashing.

Preselecting Speed / RCF

1. Press the   key below the field speed / RCF value. Next to the display a light shows the actual unit.



2. The display shows the speed or the RCF value depending on the display setting. Press the  key to toggle between the two modes.
3. Enter the desired value by pressing   up or down.
The speed can be selected between 300rpm and 10.000rpm and can be altered by 10rpm.
The RCF can be set in steps of 1.
4. The value is stored when the value stops flashing.

Note If an extremely low RCF value has been selected, it will be corrected automatically if the resulting speed is less than 300 rpm.

Explanation of RCF Value

The relative centrifugal force (RCF) is given as a multiple of the force of gravity g. It is a unitless numerical value which is used to compare the separation or sedimentation capacity of various devices, since it is independent of the type of device. Only the centrifuging radius and the speed come into play in it:

$$\text{RCF} = 11,18 \times \left(\frac{n}{1000} \right)^2 \times r$$

r = centrifuging radius in cm

n = rotational speed in rpm

The maximum RCF value is related to the maximum radius of the tube opening.

Remember that this value is reduced depending on the tubes and adapters used.

This can be accounted for in the calculation above if required.

K-Factor

The k-factor is an information on the sedimentation capacity of a rotor. You can calculate the required sedimentation time of each rotor with this formula:

$$t = \frac{K}{S_{20,w}}$$

t = sedimentation time in hours

K = clearing factor of the rotor (K-factor)

$S_{20,w}$ = Sedimentation factor for sample particles in water at 20 °C in Svedbergs

The k-factors given in this manual refer to:





r_{\max} = bucket bottom, (bottom of cavity of fixed angled rotors)

r_{\min} = bucket upper edge, (upper edge of cavity of fixed angled rotors)

Tubes which have various radii due to adapter or micro plate carriers the k-factor can be calculated by using this formula:

$$K = (253000) \left[n \left(\frac{r_{\max}}{r_{\min}} \right) \right] \div \left(\frac{\text{Speed}}{1000} \right)^2$$





Run Time Preselection

1. Press the   key below the field running time.
2. Enter the desired value by pressing   up or down.
Up to 9 minutes 59 seconds the duration is given exactly to the second. After 10 minutes the

minutes are given.



Continuous Operation

1. Press the   key below the field running time.
2. Press the   key up or down until the following is shown:





During continuous operation, the centrifuge will continue running until you stop it manually with the  key.

Limited Time Mode



You can limit the run time to 9:59.

1. Press the  key for 1 second.
The display shows:







2. Press the   key below the field speed upwards.
The display shows:



3. Press the   key below the field run time upwards.
You can either choose the limited time mode 0.00 or the standard mode 00.0.

Preselecting the Temperature



You can preselect temperatures between -9 °C and +40 °C.

1. Press the   key below the field temperature.
2. Enter the desired value by pressing   up or down.
The temperature can be set in steps of 1.
The value is stored when the value stops flashing.



Pre-warming or Pre-cooling the Centrifuge

For setting the pre-temp value for the centrifuge proceed as follows:

1. Press the  key and enter the desired value by pressing   up or down.
The display shows:



2. Press the  key.
The rotor will be pre-tempered for 30 to 60 minutes.

Bucket Selection

Bucket selection is only possible for swing-out rotors.

The bucket code corresponds to the last four digits of the bucket catalog number.



The selected bucket is needed to calculate the RCF value and control the temperature.

1. Press the  key below the field speed / RCF value until the correct bucket is shown:





2. The RCF value is stored and the display shows the speed or RCF value.

Setting up a Program

1. Press the  key below the field program until the correct number in the program memory is shown: The display flashes.
2. Press the  key.
All displays flash.
 1. Enter the program parameters.
 2. As described above, please enter braking and acceleration profile, speed/ RCF value, run time, temperatures, and bucket.
The value that is being changed flashes.
3. Press the  key again when all displays are flashing again.
The display with the number of the program memory flashes and all settings are stored.

Changing the Settings during a Run

You can change the set values during a run. Press either the key   or  below the display. The value that is being changed flashes. When the new value is stored the actual value is shown in the display.

Centrifugation

Once the rotor has been properly installed, the main switch has been turned on and the door has been closed, you can start centrifuging.

Starting Centrifuge Program

Press the  key on the control panel. The centrifuge accelerates up to the set value. The time display shows the remaining run time. If you have selected continuous operation the time display counts up.

If you have selected a value that is above the maximum speed or RCF value the display will flash for 15 seconds between **rotor** and the maximum value for the installed rotor.

- a. Please enter a new value. Within this period, it is possible to accept this value by again pressing the  key. The centrifugation is then continued.
- b. After 15 sec. the rotor will be decelerated. Always wait until the rotor has come to a stop without braking.
By opening and closing the door you reset the message **rotor**.
After entering a permissible speed you can start again.

You cannot open the door as long as the centrifuge is running.

Imbalance Indicator

If a load is imbalanced, this will be indicated at speed higher than approx. 300rpm. The display shows the following message:



The run will terminate.

Check the loading and start the centrifuge once again. See the information on proper loading in the rotor instruction manual. For information on troubleshooting, see section [“Vom Anwender behebbare Fehler”](#) auf [Seite 6-3](#).

Stopping the Centrifugation Program



With preset Running Time

Usually the run time is preset and you only have to wait until the centrifuge stops automatically when the preset time limit expires.

As soon as the speed drops to zero, the message **End** will appear in the display. By pressing the  key, you can open the door and remove the centrifuge material.

You can also stop the centrifuging program manually at any time by pressing the  key.

Continuous Operation

If you selected continuous operation (see “[Continuous Operation](#)” on [page 4-6](#)), you will have to stop the centrifuge manually. Press the  key on the control panel. The centrifuge will be decelerated at the designated rate. As soon as the speed drops to zero, the message **End** will appear in the display. By pressing the  key, you can open the door and remove the sample.

Temperature Adaptation during Standstill

The temperature cannot be adapted until the rotor has been positively identified. For this, the centrifuge must have accelerated to over 300rpm. The speed display will then show **End**.

When the rotor is not recognized (door closed and  key not yet pressed, speed display **0**), the centrifuge responds by ensuring that the sample cannot freeze regardless of the rotor being used.

Short-term Centrifugation

For short-term centrifuging, the Cryofuge 5500i has a PULSE- function.

By holding down the  key, spinning will start and continue until the key is let go.

The centrifuge accelerates and brakes at maximum power. Any rpm or RCF entered beforehand is overridden.

Note The centrifuge accelerates to maximum speed, regardless of which rotor was installed.

Check carefully whether you have to maintain a certain speed for your application.

During the acceleration process, time is counted forwards in seconds. The reading stays displayed until the centrifuge door is opened.

Removing the Rotor

To remove the rotor, proceed as follows:

1. Open the centrifuge door.

4 Operation

Aligning the Centrifuge

2. Thread the fastening tool in the centrifuge spindle counter-clockwise. Hold the rotor with the other hand into position.
3. At the same time, pull the rotor directly upwards with both hands and remove it from the centrifuge spindle. Make sure not to tilt the rotor while doing this.

Aerosol-tight Rotors

When using an aerosol tight lid the rotor can only be removed with the lid closed. This is to protect you and the samples.

Aligning the Centrifuge

1. To turn off the centrifuge put the mains switch to "0".





Audible Alarm

Error messages are accompanied by an audible alarm. Press any key to silence the audible alarm.

The end of run can also be accompanied by an audible alarm. To switch off this signal proceed as follows:

1. Press the  key for 1 second.
The display shows the current setting.





2. Use the   key below the field run time until it says **ON** in the display if the centrifuge should make an audible alarm after the run.
Use the   key below the field run time until it says **OFF** in the display if the centrifuge should not make an audible alarm after the run.

Note If the message **rotor** appears in the display the selected speed or RCF value are too high. If you press the  key the centrifuge accelerates to the shown maximum value.

Key Switch

The key can lock some functions of the centrifuge.

Key position	Description
A	All settings can be changed. The user can change and use all programs in the program memory. PULSE and the pre-temp function can be used.
B	The program memory is protected against changes. The user can use all programs but cannot change them. PULSE and the pre-temp function can be used.
C	Program memory and RAM are protected against changes. All set parameters are blocked, but the actual program can be operated as often as needed with the control keys ( ,  , ). All set values can be seen with the arrow keys. The selected program cannot be changed. PULSE and the pre-temp function are locked.

Maintenance and Care

Contents

- “Cleaning Intervals” on page 5-2
- “Cleaning” on page 5-2
- “Cleaning the Venting Slots” on page 5-3
- “Disinfection” on page 5-3
- “Decontamination” on page 5-4
- “Service of Thermo Fisher Scientific” on page 5-5

Cleaning Intervals

For the sake of personal, environmental, and material protection, it is your duty to clean and if necessary disinfect the centrifuge on a regular basis.

Maintenance	Recommended Interval
Clean Rotor Chamber	daily or when polluted
Clean Rotor	daily or when polluted
Accessories	daily or when polluted
Cabinet	Once per month
Ventilation Holes	Every six months



CAUTION Refrain from using any other cleaning or decontamination procedure than those recommended here, if you are not entirely sure that the intended procedure is safe for the equipment.
Use only approved cleansers.
If in doubt, contact Thermo Fisher Scientific.

Cleaning

When cleaning centrifuge mind the following:

- Use warm water with a neutral solvent.
- Never use caustic cleaning agents such as soap suds, phosphoric acid, bleaching solutions or scrubbing powder.
- Use a soft brush without metal bristles to remove stubborn residue.
- Afterwards rinse with distilled water.
- Use only disinfectants with a pH of 6-8.



CAUTION Before using any cleaning or decontamination methods except those recommended by the manufacturer, users should check with the manufacturer that the proposed method will not damage the equipment.

Clean centrifuge and accessories as follows:

1. Open the centrifuge.
2. Turn off the centrifuge.
3. Pull out the power supply plug.
4. Release the rotor.
5. Grasp the rotor with both hands and lift it vertically off the centrifuge spindle.

6. Use a neutral cleaning agent with a pH value between 6 and 8 for cleaning.



CAUTION When cleaning, do not allow liquids, especially organic solvents, to get on the drive shaft or the bearings of the centrifuge. Organic solvents break down the grease in the motor bearing. The drive shaft could freeze up.

After some applications there might be ice in the rotor chamber. Let the ice melt and drain it off. Clean the rotor chamber as described above.

Cleaning the Venting Slots

For cleaning the venting slots proceed as follows:

1. Turn off the centrifuge.
2. Pull out the power supply plug.
3. Remove the lateral fastening screws and demount the venting grid.

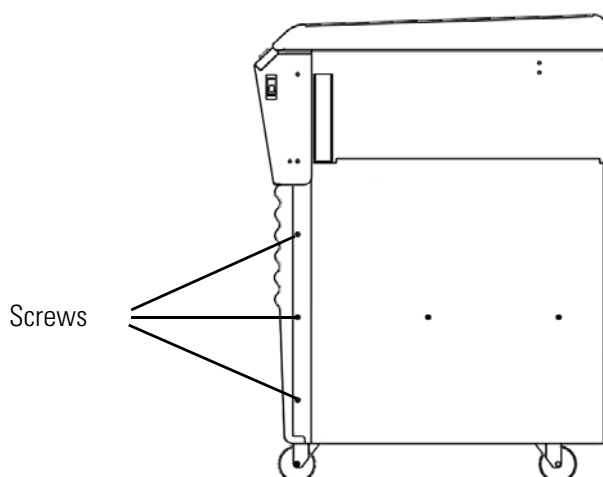

Figure 5-1. Open centrifuge

4. Clean the cooling fins carefully with a brush. Make sure you do not deform the cooling fins.
5. Place the venting grid again and fastened the screws thoroughly.

Disinfection

Disinfect the centrifuge immediately whenever infectious material has spilled during centrifugation.



WARNING Infectious material can get into the centrifuge when a tube breaks or as a result of spills. Keep in mind the risk of infection when touching the rotor and take all necessary precautions.

In case of contamination, make sure that others are not put at risk. Decontaminate the affected parts immediately. Take other precautions if need be.

The rotor chamber should be treated preferably with a neutral disinfectant.



CAUTION Before using any cleaning or decontamination methods except those recommended by the manufacturer, users should check with the manufacturer that the proposed method will not damage the equipment. Observe the safety precautions and handling instructions for the cleaning agents used.

Contact the Service Department of Thermo Fisher Scientific for questions regarding the use of other disinfectants.

Disinfect the rotor and accessories as follows:

1. Open the centrifuge.
2. Turn off the centrifuge.
3. Pull out the power supply plug.
4. Release the rotor.
5. Grasp the rotor with both hands and lift it vertically off the centrifuge spindle.
6. Treat the centrifuge according to the instructions for the disinfectant. Adhere strictly to the given application times.
7. Wipe off the disinfectant.
8. Rinse thoroughly with water.
9. Dispose of the disinfectant according to the applicable guidelines.

Decontamination

Decontaminate the centrifuge immediately whenever contaminating material has spilled during centrifugation.



WARNING Infectious material can get into the centrifuge when a tube breaks or as a result of spills. Keep in mind the risk of infection when touching the rotor and take all necessary precautions. In case of contamination, make sure that others are not put at risk. Decontaminate the affected parts immediately. Take other precautions if need be.



CAUTION Before using any cleaning or decontamination methods except those recommended by the manufacturer, users should check with the manufacturer that the proposed method will not damage the equipment.

For general radioactive decontamination use a solution of equal parts of 70% ethanol, 10% SDS and water.

1. Open the centrifuge.
2. Turn off the centrifuge.
3. Pull out the power supply plug.

4. Release the rotor.
5. Grasp the rotor with both hands and lift it vertically off the centrifuge spindle.
6. Remove the centrifuge tubes and adapters and dispose of them or disinfect them.
7. Rinse the centrifuge first with ethanol and then with de-ionized water.
 - Adhere strictly to the given application times.
8. Wipe off the disinfectant.
9. Rinse thoroughly with water.
10. Dispose of the decontamination solution according to the applicable guidelines.

Service of Thermo Fisher Scientific

Thermo Fisher Scientific recommends having the centrifuge and accessories serviced once a year by an authorized service technician. The service technicians check the following:

- the electrical equipment
- the suitability of the set-up site
- the door lock and the safety system
- the rotor
- the fixation of the rotor and the drive shaft

Thermo Fisher Scientific offers inspection and service contracts for this work. Any necessary repairs are performed for free during the warranty period and afterwards for a charge.

This is only valid if the centrifuge has only been maintained by a Thermo Fisher Scientific service technician.

Troubleshooting

Contents

- “Mechanical Emergency Door Release” on page 6-2
- “Troubleshooting by User” on page 6-3
- “When to contact a Service Technician” on page 6-5

Mechanical Emergency Door Release

During a power failure, you will not be able to open the centrifuge door with the regular electric lid release. A mechanical override is provided to allow sample recovery in the case of an emergency. However, this should be used only in emergencies and after the rotor has come to a complete stop.



WARNING The rotor can still be spinning at high speed. If touched, it can cause serious injuries.

Always wait a few minutes until the rotor has come to a stop without braking. The brake does not work when there is no current. The braking process lasts much longer than usual.

Proceed as follows:

1. Make sure the rotor has stopped (view port in the door).



WARNING Never use your hand or any tools to brake the rotor.

2. Pull out the power supply plug.
3. On both sides of the housing are two white plastic plugs which you can pry out of the back plate with a screwdriver or a knife. Pull the release cords attached to it at the same time to trigger the mechanical door release. The door will open and the samples can be removed.

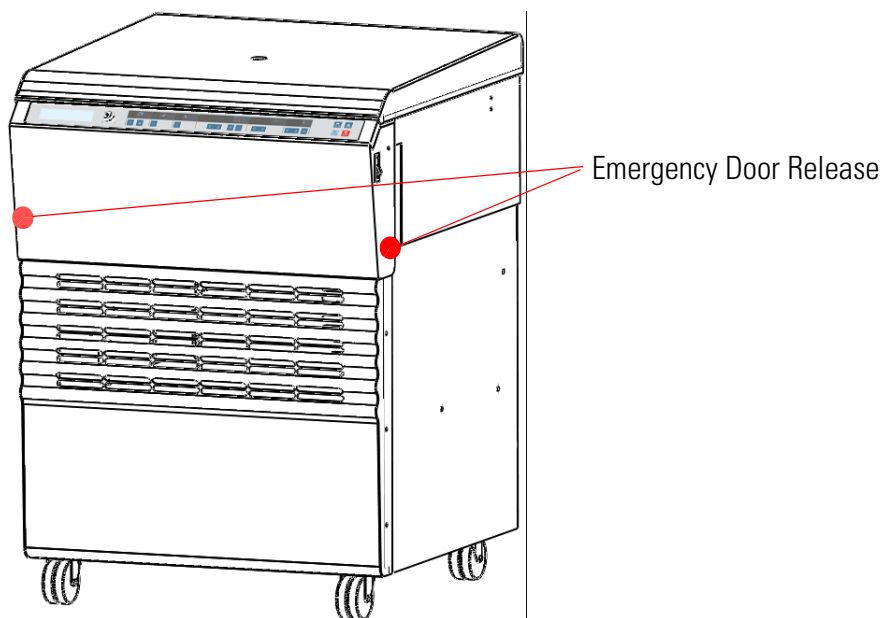



Figure 6-1. Emergency Door Release

Note You need to pull both release cords in order to unlock both locks.

4. Push the release cords back into the centrifuge and mount the plug.
5. Reconnect the centrifuge once the power has been restored. Switch on the centrifuge. Press the  key to have the door locks operative again.



Troubleshooting by User



If problems occur other than those listed in this table, the authorized customer service representative must be contacted.

Failure message	Problem with centrifuge	Possible causes and cures
Display remains dark.	The drive stops. The run does not start or the centrifuge runs down without being braked. The centrifuge door cannot be opened.	No mains connection. Check whether the switch is properly pressed. Check the mains connection. If an error message appears again, inform a service technician.
Display fails briefly.	The drive stops. Rotor stops with deceleration to standstill. Message E-14 appears in display.	Mains connection interrupted for some seconds. Turn off mains switch. Check whether the mains power cord is connected properly. Restart the centrifuge. If an error message appears again, inform a service technician.
The centrifuge door cannot be opened.	Centrifuge does not open.	Restart the centrifuge. The emergency door release enables you to retrieve your samples. If an error message appears again, inform a service technician.
-	Exceptionally running noise.	Check the load placed in the rotor. Check that the rotor cross bolts are well greased. Restart the centrifuge. If an error message appears again, inform a service technician.
Message bAI appears in display.	Rotor stops with deceleration to standstill.	Imbalance detected. Check the load placed in the rotor. Check that the bolts of the rotor are well greased. Restart the centrifuge. If an error message appears again, inform a service technician.
The message rotor appears in display.	Rotor stops with deceleration.	Set speed exceeds permissible maximum speed for the rotor. (The same holds for RCF setting) a. For approx. 15 sec. the maximum permissible rotor speed or rcf for the inserted rotor will be shown alternately by rotor in the display. Within this period, it is possible to accept this value by again pressing the  key. The centrifugation is then continued. b. After 15 sec. the rotor will be decelerated. Always wait until the rotor has come to a stop without braking. By opening and closing the door you reset the message rotor . After entering a permissible speed you can start again.

Failure message	Problem with centrifuge	Possible causes and cures
Display OPEN appears although door is closed.	Centrifuge will not start.	a. Centrifuge door not properly closed. Open the centrifuge door and repeat locking procedure. b. Over-temperature in the motor detected. Pull out the power supply plug. Control and clean the venting grid. Wait some 20 minutes before starting the centrifuge again. If an error message appears again, inform a service technician.
Message Lid appears in display.	The run does not start or the centrifuge runs down without being braked.	Centrifuge door was opened manually during the run. Close the door again. The centrifuge decelerates without braking. Restart the centrifuge.
Message Lift Lid appears in display.	Door does not open automatically.	Door has not been lifted off the lock during opening. 1. Avoid laying objects onto the centrifuge door. 2. Lift the door slightly.
E-00	Motor does not start.	Motor or rotor are blocked. Restart the centrifuge. Open the centrifuge door. Check whether the rotor can turn freely. If an error message appears again, inform a service technician.
E-02	The run does not start or the centrifuge runs down without being braked.	Internal program error in the memory Restart the centrifuge. If an error message appears again, inform a service technician.
E-03	The run does not start or the centrifuge runs down without being braked.	Error in speed entry. Restart the centrifuge. If an error message appears again, inform a service technician.
E-04	The run does not start or the centrifuge runs down without being braked.	Temperature measurement malfunction (sensor fracture). Restart the centrifuge. If an error message appears again, inform a service technician.
E-06	The run does not start or the centrifuge runs down without being braked.	Communication error between key panel and CPU. Restart the centrifuge. If an error message appears again, inform a service technician.
E-07	The rotor is decelerated to a standstill. The lid can be opened.	Overheating in chamber. Display > 51 °C or measured temperature > 70 °C. Clean the cooling fins in the back. (Cooling machine might be defective.)
E-08	The run does not start or the centrifuge runs down without being braked.	Over voltage at frequency converter. Mains voltage outside the tolerance. Deceleration resistance defective. Restart the centrifuge. If an error message appears again, inform a service technician.
E-10	Self-test after switching on the centrifuge.	NV-RAM; error in program memory Restart the centrifuge. If an error message appears again, inform a service technician.

Failure message	Problem with centrifuge	Possible causes and cures
E-12	The run does not start or the centrifuge runs down without being braked.	Temperature measurement error Restart the centrifuge. If an error message appears again, inform a service technician.
E-14	Centrifuge does not start or decelerates to standstill.	No rotor present or rotor identification impossible. a. Check whether a certified rotor is inserted. b. Following a brief power failure, the rotor could not be identified. Restart the centrifuge. If an error message appears again, inform a service technician.
E-15	The run does not start or the centrifuge runs down without being braked.	The check sum in the NV-RAM is incorrect.
E-17	Door does not open.	Door is blocked or jammed. Press the door down once at the front in the center and then actuate the  key again. Otherwise see “Mechanical Emergency Door Release” on page 6-2 .
E-19	The centrifuge cannot be operated.	Incorrect NV-RAM or key panel
E-22	The centrifuge cannot be operated.	NV-RAM parameter does not fit the processor
E-24	The centrifuge cannot be operated.	NV-RAM 2 missing
E-25	The run does not start or the centrifuge runs down without being braked.	Start without rotor. Open the centrifuge by pressing the  key. Check whether the rotor is installed and loaded properly. Check whether a broken tube or damaged rotor released the imbalance switch. Restart the centrifuge. If an error message appears again, inform a service technician.

When to contact a Service Technician

If you need to contact a service technician, please provide the order no. and the serial no. of your centrifuge. You will find these information at the top right.

To identify the software version, proceed as follows:

1. Turn on the power switch on the right side of the device.
The centrifuge performs a self-check of its software. Subsequently, the following readings will be displayed. The order is:



Software version key panel

Software version

NV-RAM-Version 1

6 Troubleshooting

When to contact a Service Technician

A digital display with two segments. The left segment shows the number '7211' and the right segment shows the number '2'. Both segments have small icons on the right side.

NV-RAM-Version 2

A digital display with two segments. The left segment shows the number '235' and the right segment shows the letters 'CY'. Both segments have small icons on the right side.

Cycle counter

Note The values given are only examples.

2. Afterwards the different programs are tested as well.

A digital display with three segments. The first segment shows 'tEST', the second shows 'Pro', and the third shows '9'. Each segment has small icons on the right side.

Program test

3. Communicate the software version to the service technician.

Chemical Compatibility Chart

CHEMICAL	MATERIAL	ALUMINUM	ANODIC COATING for ALUMINUM	BUNA N	CELLULOSE ACETATE BUTYRATE	POLYURETHANE ROTOR PAINT	COMPOSITE Carbon Fiber/Epoxy	DELRIIN	ETHYLENE PROPYLENE	GLASS	NEOPRENE	NORYL	NYLON	PET ¹ , POLYCLEAR, CLEARCRIMP	POLYALLOMER	POLYCARBONATE	POLYESTER, GLASS THERMOSET	POLYETHERIMIDE	POLYTRHYLENE	POLYPROPYLENE	POLYSULFONE	POLYVINYL CHLORIDE	RULON A, TEFLON	SILICONE RUBBER	STAINLESS STEEL	TITANIUM	TYGON	VITON
2-mercaptoethanol	S	S	U	-	S	M	S	-	S	U	S	S	U	S	S	-	S	S	S	S	U	S	S	S	S	S	S	S
Acetaldehyde	S	-	U	U	-	-	-	M	-	U	-	-	-	M	U	U	U	M	M	-	M	S	U	-	S	-	U	
Acetone	M	S	U	U	S	U	M	S	S	U	U	S	U	S	U	U	U	S	S	U	U	S	M	M	S	U	U	
Acetonitrile	S	S	U	-	S	M	S	-	S	S	U	S	U	M	U	U	-	S	M	U	U	S	S	S	S	U	U	
Alconox	U	U	S	-	S	S	S	-	S	S	S	S	S	S	M	S	S	S	S	S	S	S	S	S	S	S	S	U
Allyl Alcohol	-	-	-	U	-	-	S	-	-	-	-	S	-	S	S	M	S	S	S	-	M	S	-	-	S	-	-	
Aluminum Chloride	U	U	S	S	S	S	U	S	S	S	S	S	M	S	S	S	S	-	S	S	S	S	S	M	U	U	S	S
Formic Acid (100%)	-	S	M	U	-	-	U	-	-	-	-	U	-	S	M	U	U	S	S	-	U	S	-	U	S	-	U	
Ammonium Acetate	S	S	U	-	S	S	S	-	S	S	S	S	S	S	S	U	-	S	S	S	S	S	S	S	S	S	S	S
Ammonium Carbonate	M	S	U	S	S	S	S	S	S	S	S	S	S	S	U	U	-	S	S	S	S	S	S	M	S	S	S	S
Ammonium Hydroxide (10%)	U	U	S	U	S	S	M	S	S	S	S	S	-	S	U	M	S	S	S	S	S	S	S	S	S	S	M	S
Ammonium Hydroxide (28%)	U	U	S	U	S	U	M	S	S	S	S	S	U	S	U	M	S	S	S	S	S	S	S	S	S	S	M	S
Ammonium Hydroxide (conc.)	U	U	U	U	S	U	M	S	-	S	-	S	U	S	U	U	S	S	S	-	M	S	S	S	S	-	U	
Ammonium Phosphate	U	-	S	-	S	S	S	S	S	S	S	S	-	S	S	M	-	S	S	S	S	S	S	M	S	S	S	S
Ammonium Sulfate	U	M	S	-	S	S	U	S	S	S	S	S	S	S	S	S	-	S	S	S	S	S	S	U	S	S	U	
Amyl Alcohol	S	-	M	U	-	-	S	S	-	M	-	S	-	M	S	S	S	S	M	-	-	-	U	-	S	-	M	
Aniline	S	S	U	U	S	U	S	M	S	U	U	U	U	U	U	U	-	S	M	U	U	S	S	S	S	U	S	
Sodium Hydroxide (<1%)	U	-	M	S	S	S	-	-	S	M	S	S	-	S	M	M	S	S	S	S	S	S	M	S	S	-	U	
Sodium Hydroxide (10%)	U	-	M	U	-	-	U	-	M	M	S	S	U	S	U	U	S	S	S	S	S	S	M	S	S	-	U	
Barium Salts	M	U	S	-	S	S	S	S	S	S	S	S	S	S	S	M	-	S	S	S	S	S	M	S	S	S	S	S
Benzene	S	S	U	U	S	U	M	U	S	U	U	S	U	U	U	M	U	M	U	U	U	S	U	U	S	U	S	S
Benzyl Alcohol	S	-	U	U	-	-	M	M	-	M	-	S	U	U	U	U	U	U	U	-	M	S	M	-	S	-	S	
Boric Acid	U	S	S	M	S	S	U	S	S	S	S	S	S	S	S	S	U	S	S	S	S	S	S	S	S	S	S	S
Cesium Acetate	M	-	S	-	S	S	S	-	S	S	S	S	-	S	S	-	-	S	S	S	S	S	M	S	S	S	S	S

A Chemical Compatibility Chart

CHEMICAL	MATERIAL																											
	ALUMINUM	ANODIC COATING for ALUMINUM	BUNA N	CELLULOSE ACETATE BUTYRATE	POLYURETHANE ROTOR PAINT	COMPOSITE Carbon Fiber/Epoxy	DELRIN	ETHYLENE PROPYLENE	GLASS	NEOPRENE	NORYL	NYLON	PET ¹ , POLYCLEAR, CLEARCRIMP	POLYALLUMER	POLYCARBONATE	POLYESTER, GLASS THERMOSET	POLYETHERIMIDE	POLYETHYLENE	POLYPROPYLENE	POLYSULFONE	POLYVINYL CHLORIDE	RULON A, TEFLON	SILICONE RUBBER	STAINLESS STEEL	TITANIUM	TYGON	VITON	
Cesium Bromide	M	S	S	-	S	S	S	-	S	S	S	S	S	S	S	-	-	S	S	S	S	S	S	M	S	S	S	
Cesium Chloride	M	S	S	U	S	S	S	-	S	S	S	S	S	S	S	-	-	S	S	S	S	S	S	M	S	S	S	
Cesium Formate	M	S	S	-	S	S	S	-	S	S	S	S	S	S	S	-	-	S	S	S	S	S	S	M	S	S	S	
Cesium Iodide	M	S	S	-	S	S	S	-	S	S	S	S	S	S	S	-	-	S	S	S	S	S	S	M	S	S	S	
Cesium Sulfate	M	S	S	-	S	S	S	-	S	S	S	S	S	S	S	-	-	S	S	S	S	S	S	M	S	S	S	
Chloroform	U	U	U	U	S	S	M	U	S	U	U	M	U	M	U	U	U	M	M	U	U	S	U	U	U	M	S	
Chromic Acid (10%)	U	-	U	U	S	U	U	-	S	S	S	U	S	S	M	U	M	S	S	U	M	S	M	U	S	S	S	
Chromic Acid (50%)	U	-	U	U	-	U	U	-	-	-	S	U	U	S	M	U	M	S	S	U	M	S	-	U	M	-	S	
Cresol Mixture	S	S	U	-	-	-	S	-	S	U	U	U	U	U	U	-	-	U	U	-	U	S	S	S	S	U	S	
Cyclohexane	S	S	S	-	S	S	S	U	S	U	S	S	U	U	U	M	S	M	U	M	M	S	U	M	M	U	S	
Deoxycholate	S	S	S	-	S	S	S	-	S	S	S	S	S	S	S	-	-	S	S	S	S	S	S	S	S	S	S	
Distilled Water	S	S	S	S	S	S	S	S	S	S	S	S	S	S	S	S	S	S	S	S	S	S	S	S	S	S	S	
Dextran	M	S	S	S	S	S	S	-	S	S	S	S	S	S	S	S	S	S	S	S	S	S	S	M	S	S	S	
Diethyl Ether	S	S	U	U	S	S	S	U	S	U	U	S	U	U	U	U	U	U	U	U	U	S	S	S	S	M	U	
Diethyl Ketone	S	-	U	U	-	-	M	-	S	U	-	S	-	M	U	U	U	M	M	-	U	S	-	-	S	U	U	
Diethylpyrocarbonate	S	S	U	-	S	S	S	-	S	S	U	S	U	S	U	-	-	S	S	S	M	S	S	S	S	S	S	
Dimethylsulfoxide	S	S	U	U	S	S	S	-	S	U	S	S	U	S	U	U	-	S	S	U	U	S	S	S	U	U	U	
Dioxane	M	S	U	U	S	S	M	M	S	U	U	S	U	M	U	U	-	M	M	M	U	S	S	S	S	U	U	
Ferric Chloride	U	U	S	-	-	-	M	S	-	M	-	S	-	S	-	-	-	S	S	-	-	-	M	U	S	-	S	
Acetic Acid (Glacial)	S	S	U	U	S	S	U	M	S	U	S	U	U	U	U	U	M	S	U	M	U	S	U	U	S	-	U	
Acetic Acid (5%)	S	S	M	S	S	S	M	S	S	S	S	S	M	S	S	S	S	S	S	S	M	S	S	M	S	S	M	
Acetic Acid (60%)	S	S	U	U	S	S	U	-	S	M	S	U	U	M	U	S	M	S	M	S	M	S	M	U	S	M	U	
Ethyl Acetate	M	M	U	U	S	S	M	M	S	S	U	S	U	M	U	U	-	S	S	U	U	S	M	M	S	U	U	
Ethyl Alcohol (50%)	S	S	S	S	S	S	M	S	S	S	S	S	U	S	U	S	S	S	S	S	S	S	S	M	S	M	U	
Ethyl Alcohol (95%)	S	S	S	U	S	S	M	S	S	S	S	S	U	S	U	-	S	S	S	M	S	S	S	U	S	M	U	
Ethylene Dichloride	S	-	U	U	-	-	S	M	-	U	U	S	U	U	U	U	U	U	U	-	U	S	U	-	S	-	S	
Ethylene Glycol	S	S	S	S	S	S	S	S	S	S	S	S	-	S	U	S	S	S	S	S	S	S	S	M	S	M	S	
Ethylene Oxide Vapor	S	-	U	-	-	U	-	-	S	U	-	S	-	S	M	-	-	S	S	S	U	S	U	S	S	S	U	
Ficoll-Hypaque	M	S	S	-	S	S	S	-	S	S	S	S	-	S	S	-	S	S	S	S	S	S	M	S	S	S	S	
Hydrofluoric Acid (10%)	U	U	U	M	-	-	U	-	-	U	U	S	-	S	M	U	S	S	S	S	M	S	U	U	U	-	-	
Hydrofluoric Acid (50%)	U	U	U	U	-	-	U	-	-	U	U	U	U	S	U	U	U	S	S	M	M	S	U	U	U	-	M	

CHEMICAL	MATERIAL																										
	ALUMINUM	ANODIC COATING for ALUMINUM	BUNA N	CELLULOSE ACETATE BUTYRATE	POLYURETHANE ROTOR PAINT	COMPOSITE Carbon Fiber/Epoxy	DELRIN	ETHYLENE PROPYLENE	GLASS	NEOPRENE	NORYL	NYLON	PET ¹ , POLYCLEAR, CLEARCRIMP	POLYALLOMER	POLYCARBONATE	POLYESTER, GLASS THERMOSET	POLYETHERIMIDE	POLYETHYLENE	POLYPROPYLENE	POLYSULFONE	POLYVINYL CHLORIDE	RULON A, TEFLON	SILICONE RUBBER	STAINLESS STEEL	TITANIUM	TYGON	VITON
Hydrochloric Acid (conc.)	U	U	U	U	-	U	U	M	-	U	M	U	U	M	U	U	U	-	S	-	U	S	U	U	U	-	-
Formaldehyde (40%)	M	M	M	S	S	S	S	M	S	S	S	S	M	S	S	S	U	S	S	M	S	S	S	M	S	M	U
Glutaraldehyde	S	S	S	S	-	-	S	-	S	S	S	S	S	S	S	-	-	S	S	S	-	-	S	S	S	-	-
Glycerol	M	S	S	-	S	S	S	S	S	S	S	S	S	S	S	S	-	S	S	S	S	S	S	S	S	S	S
Guanidine Hydrochloride	U	U	S	-	S	S	S	-	S	S	S	S	S	S	S	-	-	S	S	S	S	S	S	U	S	S	S
Haemo-Sol	S	S	S	-	-	-	S	-	S	S	S	S	S	S	S	-	-	S	S	S	S	S	S	S	S	S	S
Hexane	S	S	S	-	S	S	S	-	S	S	U	S	U	M	U	S	S	U	S	S	M	S	U	S	S	U	S
Isobutyl Alcohol	-	-	M	U	-	-	S	S	-	U	-	S	U	S	S	M	S	S	S	-	S	S	S	-	S	-	S
Isopropyl Alcohol	M	M	M	U	S	S	S	S	S	U	S	S	U	S	U	M	S	S	S	S	S	S	S	M	M	M	S
Iodoacetic Acid	S	S	M	-	S	S	S	-	S	M	S	S	M	S	S	-	M	S	S	S	S	S	M	S	S	M	M
Potassium Bromide	U	S	S	-	S	S	S	-	S	S	S	S	S	S	S	S	S	S	S	-	S	S	S	M	S	S	S
Potassium Carbonate	M	U	S	S	S	S	S	-	S	S	S	S	S	S	U	S	S	S	S	S	S	S	S	S	S	S	S
Potassium Chloride	U	S	S	-	S	S	S	S	S	S	S	S	S	S	S	-	S	S	S	S	S	S	S	U	S	S	S
Potassium Hydroxide (5%)	U	U	S	S	S	S	M	-	S	S	S	S	-	S	U	S	S	S	S	S	S	S	M	U	M	S	U
Potassium Hydroxide (conc.)	U	U	M	U	-	-	M	-	M	S	S	-	U	M	U	U	U	S	M	-	M	U	-	U	U	-	U
Potassium Permanganate	S	S	S	-	S	S	S	-	S	S	S	U	S	S	S	M	-	S	M	S	U	S	S	M	S	U	S
Calcium Chloride	M	U	S	S	S	S	S	S	S	S	S	S	S	S	M	S	-	S	S	S	S	S	S	M	S	S	S
Calcium Hypochlorite	M	-	U	-	S	M	M	S	-	M	-	S	-	S	M	S	-	S	S	S	M	S	M	U	S	-	S
Kerosene	S	S	S	-	S	S	S	U	S	M	U	S	U	M	M	S	-	M	M	M	S	S	U	S	S	U	S
Sodium Chloride (10%)	S	-	S	S	S	S	S	S	-	-	-	S	S	S	S	S	-	S	S	S	S	-	S	S	M	-	S
Sodium Chloride (sat'd)	U	-	S	U	S	S	S	-	-	-	-	S	S	S	S	S	-	S	S	-	S	-	S	S	M	-	S
Carbon Tetrachloride	U	U	M	S	S	U	M	U	S	U	U	S	U	M	U	S	S	M	M	S	M	M	M	M	U	S	S
Aqua Regia	U	-	U	U	-	-	U	-	-	-	-	-	U	U	U	U	U	U	U	-	-	-	-	-	S	-	M
Solution 555 (20%)	S	S	S	-	-	-	S	-	S	S	S	S	S	S	S	-	-	S	S	S	-	S	S	S	S	S	S
Magnesium Chloride	M	S	S	-	S	S	S	S	S	S	S	S	S	S	S	S	S	S	S	S	S	S	S	M	S	S	S
Mercaptoacetic Acid	U	S	U	-	S	M	S	-	S	M	S	U	U	U	U	-	S	U	U	S	M	S	U	S	S	S	S
Methyl Alcohol	S	S	S	U	S	S	M	S	S	S	S	S	U	S	U	M	S	S	S	S	S	S	S	M	S	M	U
Methylene Chloride	U	U	U	U	M	S	S	U	S	U	U	S	U	U	U	U	U	M	U	U	U	S	S	M	U	S	U
Methyl Ethyl Ketone	S	S	U	U	S	S	M	S	S	U	U	S	U	S	U	U	U	S	S	U	U	S	S	S	S	U	U
Metrizamide	M	S	S	-	S	S	S	-	S	S	S	S	-	S	S	-	-	S	S	S	S	S	S	M	S	S	S
Lactic Acid (100%)	-	-	S	-	-	-	-	-	-	M	S	U	-	S	S	S	M	S	S	-	M	S	M	S	S	-	S

A Chemical Compatibility Chart

CHEMICAL	MATERIAL	ALUMINUM	ANODIC COATING for ALUMINUM	BUNA N	CELLULOSE ACETATE BUTYRATE	POLYURETHANE ROTOR PAINT	COMPOSITE Carbon Fiber/Epoxy	DELRIN	ETHYLENE PROPYLENE	GLASS	NEOPRENE	NORYL	NYLON	PET ¹ , POLYCLEAR, CLEARCRIMP	POLYALLUMER	POLYCARBONATE	POLYESTER, GLASS THERMOSET	POLYETHERIMIDE	POLYRTHYLENE	POLYPROPYLENE	POLYSULFONE	POLYVINYL CHLORIDE	RULON A, TEFLON	SILICONE RUBBER	STAINLESS STEEL	TITANIUM	TYGON	VITON
Lactic Acid (20%)	-	-	S	S	-	-	-	-	-	M	S	M	-	S	S	S	S	S	S	S	S	M	S	M	S	S	-	S
N-Butyl Alcohol	S	-	S	U	-	-	S	-	-	S	M	-	U	S	M	S	S	S	S	S	M	M	S	M	-	S	-	S
N-Butyl Phthalate	S	S	U	-	S	S	S	-	S	U	U	S	U	U	U	M	-	U	U	S	U	S	M	M	S	U	S	
N, N-Dimethylformamide	S	S	S	U	S	M	S	-	S	S	U	S	U	S	U	U	-	S	S	U	U	S	M	S	S	S	U	
Sodium Borate	M	S	S	S	S	S	S	S	S	S	S	U	S	S	S	S	S	-	S	S	S	S	S	M	S	S	S	
Sodium Bromide	U	S	S	-	S	S	S	-	S	S	S	S	S	S	S	S	S	-	S	S	S	S	S	M	S	S	S	
Sodium Carbonate (2%)	M	U	S	S	S	S	S	S	S	S	S	S	S	S	U	S	S	S	S	S	S	S	S	S	S	S	S	
Sodium Dodecyl Sulfate	S	S	S	-	S	S	S	-	S	S	S	S	S	S	S	-	S	S	S	S	S	S	S	S	S	S	S	
Sodium Hypochlorite (5%)	U	U	M	S	S	M	U	S	S	M	S	S	S	M	S	S	S	S	M	S	S	S	M	U	S	M	S	
Sodium Iodide	M	S	S	-	S	S	S	-	S	S	S	S	S	S	S	-	-	S	S	S	S	S	S	M	S	S	S	
Sodium Nitrate	S	S	S	-	S	S	S	S	S	S	S	S	S	S	S	S	S	-	S	S	S	S	S	U	S	S	S	
Sodium Sulfate	U	S	S	-	S	S	S	S	S	S	S	S	S	S	S	S	S	S	S	S	S	S	S	M	S	S	S	
Sodium Sulfide	S	-	S	S	-	-	-	S	-	-	-	S	S	S	U	U	-	-	S	-	-	-	S	S	M	-	S	
Sodium Sulfite	S	S	S	-	S	S	S	M	S	S	S	S	S	S	S	M	-	S	S	S	S	S	S	S	S	S	S	
Nickel Salts	U	S	S	S	S	S	-	S	S	S	-	-	S	S	S	S	-	S	S	S	S	S	M	S	S	S	S	
Oils (Petroleum)	S	S	S	-	-	-	S	U	S	S	S	S	U	U	M	S	M	U	U	S	S	S	U	S	S	S	S	
Oils (Other)	S	-	S	-	-	-	S	M	S	S	S	S	U	S	S	S	S	U	S	S	S	S	-	S	S	M	S	
Oleic Acid	S	-	U	S	S	S	U	U	S	U	S	S	M	S	S	S	S	S	S	S	S	S	M	U	S	M	M	
Oxalic Acid	U	U	M	S	S	S	U	S	S	S	S	S	U	S	U	S	S	S	S	S	S	S	S	U	M	S	S	
Perchloric Acid (10%)	U	-	U	-	S	U	U	-	S	M	M	-	-	M	U	M	S	M	M	-	M	S	U	-	S	-	S	
Perchloric Acid (70%)	U	U	U	-	-	U	U	-	S	U	M	U	U	M	U	U	U	M	M	U	M	S	U	U	S	U	S	
Phenol (5%)	U	S	U	-	S	M	M	-	S	U	M	U	U	S	U	M	S	M	S	U	U	S	U	M	M	M	S	
Phenol (50%)	U	S	U	-	S	U	M	-	S	U	M	U	U	U	U	U	S	U	M	U	U	S	U	U	U	M	S	
Phosphoric Acid (10%)	U	U	M	S	S	S	U	S	S	S	S	U	-	S	S	S	S	S	S	S	S	S	U	M	U	S	S	
Phosphoric Acid (conc.)	U	U	M	M	-	-	U	S	-	M	S	U	U	M	M	S	S	S	M	S	M	S	U	M	U	-	S	
Physiologic Media (Serum, Urine)	M	S	S	S	-	-	S	-	S	S	S	S	S	S	S	S	S	S	S	S	S	S	S	S	S	S	S	
Picric Acid	S	S	U	-	S	M	S	S	S	M	S	U	S	S	S	U	S	S	S	S	U	S	U	M	S	M	S	
Pyridine (50%)	U	S	U	U	S	U	U	-	U	S	S	U	U	M	U	U	-	U	S	M	U	S	S	U	U	U	U	
Rubidium Bromide	M	S	S	-	S	S	S	-	S	S	S	S	S	S	S	-	-	S	S	S	S	S	S	M	S	S	S	
Rubidium Chloride	M	S	S	-	S	S	S	-	S	S	S	S	S	S	S	-	-	S	S	S	S	S	S	M	S	S	S	
Sucrose	M	S	S	-	S	S	S	S	S	S	S	S	S	S	S	S	S	S	S	S	S	S	S	S	S	S	S	

CHEMICAL	MATERIAL																											
	ALUMINUM	ANODIC COATING for ALUMINUM	BUNA N	CELLULOSE ACETATE BUTYRATE	POLYURETHANE ROTOR PAINT	COMPOSITE Carbon Fiber/Epoxy	DELRIN	ETHYLENE PROPYLENE	GLASS	NEOPRENE	NORYL	NYLON	PET*, POLYCLEAR, CLEARCRIMP	POLYALLUMER	POLYCARBONATE	POLYESTER, GLASS THERMOSET	POLYETHERIMIDE	POLYRTHYLENE	POLYPROPYLENE	POLYSULFONE	POLYVINYL CHLORIDE	RULON A, TEFLON	SILICONE RUBBER	STAINLESS STEEL	TITANIUM	TYGON	VITON	
Sucrose, Alkaline	M	S	S	-	S	S	S	-	S	S	S	S	S	S	U	S	S	S	S	S	S	S	S	M	S	S	S	
Sulfosalicylic Acid	U	U	S	S	S	S	S	-	S	S	S	U	S	S	S	-	S	S	S	-	S	S	S	U	S	S	S	
Nitric Acid (10%)	U	S	U	S	S	U	U	-	S	U	S	U	-	S	S	S	S	S	S	S	S	S	M	S	S	S	S	
Nitric Acid (50%)	U	S	U	M	S	U	U	-	S	U	S	U	U	M	M	U	M	M	M	S	S	S	U	S	S	M	S	
Nitric Acid (95%)	U	-	U	U	-	U	U	-	-	U	U	U	U	M	U	U	U	U	M	U	U	S	U	S	S	-	S	
Hydrochloric Acid (10%)	U	U	M	S	S	S	U	-	S	S	S	U	U	S	U	S	S	S	S	S	S	S	S	U	M	S	S	
Hydrochloric Acid (50%)	U	U	U	U	S	U	U	-	S	M	S	U	U	M	U	U	S	S	S	S	M	S	M	U	U	M	M	
Sulfuric Acid (10%)	M	U	U	S	S	U	U	-	S	S	M	U	S	S	S	S	S	S	S	S	S	S	U	U	U	S	S	
Sulfuric Acid (50%)	M	U	U	U	S	U	U	-	S	S	M	U	U	S	U	U	M	S	S	S	S	S	U	U	U	M	S	
Sulfuric Acid (conc.)	M	U	U	U	-	U	U	M	-	-	M	U	U	S	U	U	U	M	S	U	M	S	U	U	U	-	S	
Stearic Acid	S	-	S	-	-	-	S	M	S	S	S	S	-	S	S	S	S	S	S	S	S	S	M	M	S	S	S	
Tetrahydrofuran	S	S	U	U	S	U	U	M	S	U	U	S	U	U	U	-	M	U	U	U	U	S	U	S	S	U	U	
Toluene	S	S	U	U	S	S	M	U	S	U	U	S	U	U	U	S	U	M	U	U	U	S	U	S	U	U	M	
Trichloroacetic Acid	U	U	U	-	S	S	U	M	S	U	S	U	U	S	M	-	M	S	S	U	U	S	U	U	U	M	U	
Trichloroethane	S	-	U	-	-	-	M	U	-	U	-	S	U	U	U	U	U	U	U	U	U	S	U	-	S	-	S	
Trichloroethylene	-	-	U	U	-	-	-	U	-	U	-	S	U	U	U	U	U	U	U	U	U	S	U	-	U	-	S	
Trisodium Phosphate	-	-	-	S	-	-	M	-	-	-	-	-	-	S	-	-	S	S	S	-	-	S	-	-	S	-	S	
Tris Buffer (neutral pH)	U	S	S	S	S	S	S	-	S	S	S	S	S	S	S	S	S	S	S	S	S	S	S	S	S	S	S	
Triton X-100	S	S	S	-	S	S	S	-	S	S	S	S	S	S	S	S	S	S	S	S	S	S	S	S	S	S	S	
Urea	S	-	U	S	S	S	S	-	-	-	-	S	S	S	M	S	S	S	S	-	S	S	S	M	S	-	S	
Hydrogen Peroxide (10%)	U	U	M	S	S	U	U	-	S	S	S	U	S	S	S	M	U	S	S	S	S	S	S	M	S	U	S	
Hydrogen Peroxide (3%)	S	M	S	S	S	-	S	-	S	S	S	S	S	S	S	S	M	S	S	S	S	S	S	S	S	S	S	
Xylene	S	S	U	S	S	S	M	U	S	U	U	U	U	U	U	M	U	M	U	U	U	S	U	M	S	U	S	
Zinc Chloride	U	U	S	S	S	S	U	S	S	S	S	S	S	S	S	S	S	S	S	S	S	S	S	U	S	S	S	
Zinc Sulfate	U	S	S	-	S	S	S	S	S	S	S	S	S	S	S	S	S	S	S	S	S	S	S	S	S	S	S	
Citric Acid (10%)	M	S	S	M	S	S	M	S	S	S	S	S	S	S	S	S	M	S	S	S	S	S	S	S	S	S	S	

*Polyethyleneterephthalate

A Chemical Compatibility Chart

Key

- S Satisfactory
- M Moderate attack, may be satisfactory for use in centrifuge depending on length of exposure, speed involved, etc. Suggest testing under actual conditions of use.
- U Unsatisfactory, not recommended.
- Performance unknown; suggest testing, using sample to avoid loss of valuable material.

Chemical resistance data is included only as a guide to product use. No organized chemical resistance data exists for materials under the stress of centrifugation. When in doubt we recommend pretesting sample lots.

Contact Information

United States / Canada	866-9-THERMO +1 866 984 3766
Austria	+43 1 801 400
Belgium	+32 53 73 42 41
Germany	08001 536 376 +49 6184 90 6000
France	+33 2 2803 2180
Italy	+39 02 95059 552
Netherlands	+31 76 579 55 55
Nordic / Baltic Countries / CIS	+358 9 329 10200
Russia	+7 (812) 703 42 15
Spain / Portugal	+34 932 23 09 18
Switzerland	+41 44 454 12 22
UK / Ireland	+44 870 609 9203
China	+800 810 5118 +400 650 5118
India	+91 22 6716 2200
Japan	+81 3 5826 1616
Other Asian Countries	+852 2885 4613
Australia	+61 39757 4300
New Zealand	+64 9 980 6700
Other Countries	+49 6184 90 6000



Index

A		K	
Acceleration Curve	4-4	Keys	3-2
Accident Prevention	P-iv	L	
Aerosol-tight Rotors	4-10	Location	2-4
Autoclaving	5-5	M	
B		Mains Connection	2-5
Braking Curve	4-4	Mains Supply	1-5, 2-6
Bucket Selection	4-7	Maintenance	5-1
C		O	
Care	5-1	Operation	4-1
Centrifugation	4-8	P	
Cleaning	5-2	Precautions	P-iv
Cleaning Intervals	5-2	Preface	P-iii
Close Door	4-2	Preselecting RCF-Value	4-4
Contact Information	B-1	Preselecting Speed	4-4
Continuous Operation	4-6, 4-9	Preselecting the Temperature	4-6
D		Preset Running Time	4-9
Decontamination	5-4	Pre-warming or Pre-cooling	4-7
Disinfection	5-3	Pre-warming or Pre-cooling the Centrifuge	4-7
Door Opening	4-2	R	
E		Removing the Rotor	4-9
Emergency Door Release	6-2	Rotor Installation	4-3
Entering Parameters	4-4	Rotor Selection	1-6
Explanation of K-Factor	4-5	Run Time Preselection	4-5
Explanation of RCF Value	4-5	S	
F		Safety features	1-2
Features	1-4	Safety zone	2-4
I		Select Program	4-7
Imbalance Indicator	4-8	Service Technician	5-5, 6-5
		Short-term Centrifugation	4-9
		Starting Centrifuge Program	4-8

Index:

Stopping the Centrifugation Program 4-9
Storage 2-6
Switch on Centrifuge 4-2

T

Technical Data 1-3
Temperature Adaptation 4-9
Transporting the Centrifuge 2-4
Trouble Shooting 6-1

