

TProfessional *basic* Thermocycler

Instruction Manual

Ver. 11/06

**Model**

TProfessional Basic Gradient
TProfessional Basic
TProfessional Basic XL Gradient
TProfessional Basic XL

Order No.

070-601
070-701
070-602
070-702



Please read these instructions carefully before using this apparatus!

**Biometra GmbH**

Rudolf-Wissell-Str. 30
D-37079 Göttingen
Tel.: ++49 (0)551-50 68 6-0
Fax: ++49 (0)551-50 68 6-66
email: Info@biometra.com
Internet: <http://www.biometra.com>

Service Department
Rudolf-Wissell-Strasse 14-16
D-37079 Göttingen
Tel.: ++49 (0)551-50 68 6-10 or -12
Fax: ++49 (0)551-50 68 6-11
email: Service@biometra.com

This document describes the state at the time of publishing. It needs not necessarily agree with future versions.

Subject to change!

Contents

1	Introduction.....	5
1.1	Field of Applications	5
1.2	Special features	5
1.2.1	TProfessional Basic Thermoblock	5
1.2.2	TProfessional Basic Lid	5
1.2.3	TProfessional Basic User interface.....	5
1.2.4	TProfessional Basic Housing	5
1.3	Technical specifications.....	6
1.4	Legal Notes	7
1.4.1	PCR License – Legal Disclaimer	7
1.4.2	Copyright	7
1.4.3	Liability.....	7
1.4.4	Meaning of the Instructions.....	7
2	Safety and Warning Notices	8
2.1	Definition of Symbols.....	8
2.2	General Safety Instructions	8
3	Installation.....	11
3.1	Content of delivery.....	11
3.2	Unpack and Check	11
3.3	Installation Conditions	11
3.4	Operation Voltage.....	12
3.5	Initial self test (power on self test)	13
4	Operating elements	14
4.1	TProfessional Basic Thermocycler front view.....	14
4.2	TProfessional Basic Thermocycler rear view.....	14
4.3	The TProfessional Basic control panel	15
4.4	High Performance Smart Lid (HPSL).....	15
5	Operating.....	17
5.1	The TProfessional Basic User Interface	17
5.1.1	TProfessional Basic Menu Buttons.....	17
5.1.2	TProfessional Basic Soft Keys.....	17
5.1.3	Log in Menu	18
5.1.4	Block Menu	18
5.1.5	System Menu.....	19
5.1.6	Program Menu	19
5.2	TProfessional Basic Software.....	20
5.2.1	Navigation within software menus	20
5.2.2	Log in	20
5.2.3	Log in existing User	20
5.2.4	Create new user account.....	22
5.2.5	Supervisor Log in.....	23
5.2.6	Delete User	23

5.3	Create program	23
5.3.1	Create program from template	24
5.3.2	Create program without template	24
5.3.3	Set lid pre-heating mode	25
5.3.4	Set lid temperature	26
5.3.5	Enter step temperature and time	26
5.3.6	Set loop	27
5.3.7	Cool below ambient temperature	28
5.3.8	Program Pause	28
5.3.9	Save program	28
5.3.10	Set Gradient	31
5.3.11	Program linear gradient	32
5.4	Edit programs	33
5.4.1	Insert program step	33
5.4.2	Delete program step	35
5.4.3	Copy program	36
5.4.4	Delete program	37
5.4.5	Editing programs in the graphical mode	38
5.5	Change program options	39
5.5.1	Heating and cooling rate	40
5.5.2	Time increment → Δt (s)	40
5.5.3	Temperature increment or decrement → ΔT (°C)	41
5.6	Run program	41
5.6.1	Select program for start from User directories	41
5.6.2	Quick start programs from the block Menu	42
5.6.3	View program prior to start	42
5.6.4	Display during operation	43
5.6.5	Pause Program during run	44
5.6.6	Continue program	45
5.7	Stop program	45
5.7.1	Stop Program from a pause	45
5.8	Optimization of Fast-PCR programs	45
6	System settings	47
6.1	User configuration	47
6.1.1	Set language	47
6.1.2	Change individual PIN	47
6.1.3	Delete Account	48
6.2	System configuration	48
6.2.1	Configure beep	48
6.2.2	Configure Contrast	49
6.2.3	Set time and date	50
6.2.4	Defragment memory	50
6.2.5	Screen saver	50
6.3	System info	51
6.3.1	System info	51
6.3.2	View Log files of the last five runs	52
6.4	Service	52
6.4.1	View log files of Power on self test	53
6.4.2	Execute extended self test	53

6.4.3	View log files from extended self test	54
6.4.4	View Error log files	54
6.4.5	Create Info file for Biometra Service Department	54
6.5	How to contact Biometra	55
6.6	Supervisor system configuration.....	55
6.6.1	Change user PIN	55
6.6.2	Delete user account.....	55
6.6.3	Change supervisor PIN.....	55
6.6.4	Set boot language.....	56
6.6.5	Delete all user accounts	56
7	Short manual.....	57
8	Trouble shooting	62
8.1	Slow heating and cooling.....	62
8.2	Autorestart	62
8.3	Autorestart due to unrecognised power failure	62
8.4	Adaptation of protocols from other cyclers	62
8.5	Releasing wheel in case of blocked lid	62
9	Maintenance and repair	64
9.1	Cleaning and Maintenance	64
9.2	Servicing and repair.....	64
9.3	Firmware update.....	64
9.4	Replacement of Spare Parts	64
10	Accessories	65
10.1	Plasticware	65
11	Service.....	66
11.1	Instructions for return shipment	66
11.2	Packing of the Thermocycler	67
12	Equipment Decontamination Certificate	68
13	Note for the disposal of electric / electronic waste.....	70
14	Declaration of Conformity	71
15	Warranty.....	72
16	Subject Index	73

1 Introduction

1.1 Field of Applications

The Biometra TProfessional Basic is a Thermocycler that is licensed for PCR applications (research use only) and intended to be used for performing polymerase chain reactions. The Biometra TProfessional Basic Thermocycler is inspired by the wish to simplify molecular biology research. To reach this goal the instrument housing, lid and block were totally redesigned, providing so far unrealized temperature uniformity. Innovative user software was developed, driven by Biometras 15 years experience in interface design. The result is an easy to use Thermocycler with excellent technical specifications.

1.2 Special features

1.2.1 TProfessional Basic Thermoblock

The TProfessional Basic features a gold anodized 96 well block providing outstanding temperature uniformity. The instrument is available in two different versions: with 96 well or 96 well Gradient block.

1.2.2 TProfessional Basic Lid

The TProfessional Basic lid has been optimised to achieve two essential requirements: prevention of condensation and reliable contact between samples and thermoblock. The lid is powered by Biometras well know smart lid technology which automatically limits lid pressure to save tubes from damage. In addition, the new design of the High Performance Lid ensures an even temperature distribution between samples thus significantly improving temperature uniformity. With one press on the front button, the lid gently swings open and arrests in its end position.

1.2.3 TProfessional Basic User interface

The TProfessional Basic user interface incorporates Biometras proven spreadsheet-programming philosophy. Avoiding endless serial program windows, all steps of a program are entered in a single screen. This makes the creation of new or editing existing programs fast and easy. One touch leads from the spreadsheet to an alternative graphical programming mode. The TProfessional Basic manages up to 30 individual users (all password protected) and provides for a large program store.

1.2.4 TProfessional Basic Housing

The elegant TProfessional Basic housing is designed for heavy use. Due to an optimised air stream design even higher efficiency and better temperature uniformity is achieved. The instrument works quietly and consumes little power, which in turn leads to low heat emission. The compact footprint saves valuable bench space. Keyboard and display have been set to an angle that ensures reflection-free viewing and ergonomic programming. To facilitate servicing the TProfessional Basic housing can be completely removed from the chassis.

1.3 Technical specifications

	TProfessional Basic
Block	Gold anodized 96 well block or anodized 96 well XL block
Max. Heating Rate*	3.5 °C/sec
Max. Cooling Rate*	2.5 °C/sec
Avg. Heating Rate*	3.0 °C/sec
Avg. Cooling Rate*	2.0 °C/sec
Temperature Uniformity	55 °C: +/- 0.20 °C within 15 sec 70 °C: +/- 0.30 °C within 15 sec 95 °C: +/- 0.60 °C within 15 sec
Block Temperature Range	3 °C to 99 °C
Temperature Gradient **	26 °C
Gradient Temperature Range	20 to 99 °C
Control Accuracy	+/- 0.1 °C
Block Formats	96 well (70µl) or 96 well XL (100µl)
Programming	Easy spreadsheet programming
Software options	Quick start of the last five programs, view program prior to start, toggle between spreadsheet and graphical mode, extended self test, generate service files, adjustable ramp rates, view gradient temperature graph, PC control over RS 232
Display	¼ VGA screen, 320 x 240 pixel
Memory	350 typical programs in up to 30 user directories (password protected)
Auto restart after power failure	Yes
Heated Lid	High Performance Smart Lid (HPSL)
Lid Temperature Range	30 to 99 °C
Power consumption	max. 480 Watt
Power Supply	100, 115, 230 Volt / 50 - 60 Hz
Noise emission	Very low
Interface	RS232 serial port
Dimensions (WxDxH)	28 cm x 38 cm x 24 cm
Weight	13.0 kg
Working conditions	15 °C to 35 °C, 70 % air humidity, max 2.000 NN

* Measured inside the block. ** TProfessional Basic Gradient

1.4 Legal Notes

1.4.1 PCR License – Legal Disclaimer

Purchase of a Biometra Thermocycler conveys a limited non-transferable immunity from suit for the purchaser's own internal research and development and applied fields other than human in vitro diagnostics under one or more of US Patents Nos. 5,038,852, 5,656,493, 5,333,675, 5,475,610, and 6,703,236, or corresponding claims in their non-US counterparts, owned by Applied Biosystems Corporation.

No right is conveyed expressly, by implication or by estoppel under any patent claim, reagents, kits, or methods such as 5' nuclease methods, or under any other apparatus or system claim, including but not limited to US Patent No. 6,814,934 and its non-US counterparts, which describe and claim thermal cyclers capable of real-time detection.

Further information on purchasing licenses may be obtained by contacting the Director of Licensing, Applied Biosystems, 850 Lincoln Centre Drive, Foster City, California 94404, USA.

Biometra biomedizinische Analytik GmbH
Rudolf Wissell Str. 30
37079 Goettingen, Germany



1.4.2 Copyright

All rights reserved. It is not allowed to copy and publish the manual or parts of it in any form as copies, micro film or other methods without a written authorisation from Biometra. Biometra is pointing out that applied company and brand names are usually protected trade marks.

1.4.3 Liability





Biometra is not liable for damages and injuries caused by use not considering these operating instructions in parts or completely.

1.4.4 Meaning of the Instructions

Biometra recommends that you first read these instructions carefully. This operation instruction is part of the product and should be kept over the full life-time of the instrument. It should also be forwarded to subsequent owners and users. Make sure that additions and updates are inserted into the operation instructions.

2 Safety and Warning Notices



2.1 Definition of Symbols



<u>Symbol</u>	<u>Definition</u>
	Caution! Refer to instruction manual!
	Danger! High voltage!
	Fragile!
	Danger! Hot surface!

2.2 General Safety Instructions



Please read this manual carefully before starting operation of the TProfessional Basic Thermocycler. The TProfessional Basic Thermocycler is intended for sample incubation at varying temperatures.

- General safety precautions for laboratory work must be observed when working with the TProfessional Basic Thermocycler.
- The TProfessional Basic does not produce a sound power level that could be hazardous for the user.

  The thermoblock and the heated lid will reach high temperatures during operation. Both thermoblock and heated lid can burn you.

  Rapid heating of the thermoblock can cause liquids to boil explosively. Always wear safety goggles during operation. Close the lid before starting a program.

  Do not heat samples without having the lid locked securely.

  Be aware that samples are reaching high temperatures. Do not touch or open hot tubes or microplates, because hot liquid may quickly spill

out.



Do not touch the heated lid.



Use only suited plastic ware in the TProfessional Basic thermocycler. Tubes and plates must show good fit when placed in the thermoblock. Only use tubes that are suited for high temperatures (tight lids).



The TProfessional Basic Thermocycler contains no user serviceable parts. Do not open the housing instrument. Service and repair may only be carried out by the Biometra Service department or otherwise qualified technical personal.



Do not use the instrument when damages of the housing, block, cable or other parts are visible.



Prior to connecting the unit to the power source please ensure that the voltage selector at the bottom of the instrument is set to the required voltage.



Make sure that the main supply voltage is in accordance with the label above the power connection (see section 4.2)



Unplug the power cable before you open the TProfessional Basic Thermocycler. Danger of electric shock!



Make sure that the appliance connector and the plug of the supply cord are accessible, so you can separate the instrument from the mains.



Connect the TProfessional Basic Thermocycler to a grounded socket.



When only few samples are put in the block place additional tubes in the four corner positions. This is to evenly distribute the lid pressure and prevents single tubes from excessive pressure. Use of few tubes may result in damage of the tubes by excessive pressure.



Appropriate safety regulations must be observed when working with infectious, pathogenic or radioactive material. Ask the responsible local safety inspector for details.



The TProfessional Basic Thermocycler must not be used with explosive, flammable or volatile liquids.



Do not place fingers between lid and housing when opening or closing the lid.



Before opening of the lid, release lid pressure (see section 4.4)



It is not necessary to apply oil into the opening of the block in order to improve the heat transfer between the block and the sample tubes.

If you still decide to use oil, **do not** use silicon oil. Mineral oil may be used.



Ensure that both the rear and bottom ventilation slits not clogged by dust or other material. Danger of overheating!



Let equilibrate the TProfessional Basic Thermocycler to room temperature before starting operation.



There must be sufficient distance between the ventilation slots on the rear side of the Thermocycler and a wall or another instrument (min 10 cm). Danger of overheating!



This instrument is designed and certified to meet EN 61010-1 safety standards. It should not be modified or altered in any way. Alteration of this instrument will void the warranty, void the EN61010-1 certification, and create a potential safety hazard.



Place the TProfessional Basic Thermocycler on a stable, non flammable surface in a dry, safe environment. For details see working conditions in table "Technical specifications" (see chapter 1.3).



Do not use alcohol (e.g. methanol, ethanol), organic solvents or abrasives to clean the instrument.



For transports always use the original Biometra box.

3 Installation

3.1 Content of delivery

- 1) Thermocycler
- 2) Mains connector
- 3) Manual
- 4) Short Manual

Please keep the original packaging material for return shipment in case of servicing. The TProfessional Basic shipping box provides a specially developed system for contact-free transport of this electronic device.

3.2 Unpack and Check

Unpack and carefully examine the instrument. Report any damage to Biometra. Do not attempt to operate this device if physical damage is present.

Please keep the original packing material for return shipment in case of service issues



!! Attention !!



Please fill out and send back the warranty registration card. This is important for you to claim full warranty.

3.3 Installation Conditions

- Place the TProfessional Basic Thermocycler on a stable surface in a dry, safe environment. For details see working conditions in table “Technical specifications” (see chapter 1.3).
- Let equilibrate the TProfessional Basic Thermocycler to room temperature before starting operation (1 to 6h).
- Make sure that the appliance connector and the plug of the supply cord are accessible, so you can separate the instrument from the mains.
- Make sure that the ventilation slots on the bottom and the rear are not obstructed (see section 4.2). Make sure that there is no object underneath the thermocycler that may block the ventilation slots at the bottom (e.g. a piece of paper etc.)
- There must be sufficient distance between the ventilation slots on the rear side of the Thermocycler and a wall or another instrument (min 10 cm).

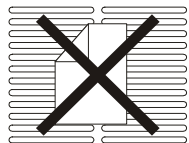
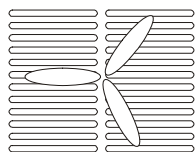

Ensure that both the rear and bottom ventilation slits of the rear and bottom of the instrument are unobstructed.

Insufficient ventilation can cause overheating of the instrument.

- Make sure that the main supply voltage is in accordance with the label above the power connection (see section 4.2)
- Connect the TProfessional Basic Thermocycler to a grounded socket.



Prior to connecting the unit to the power source please ensure that the voltage selector at the back side of the instrument is set to the required voltage.

Danger of electric shock! Unplug the power cable before you open the TProfessional Basic Thermocycler.

- The display contrast can be adjusted to local lightning conditions (6.2.2)

3.4 Operation Voltage

Important: Prior to connecting the TProfessional Basic to the mains, make sure that the setting of the Voltage selector is in accordance with your mains Voltage.

The TProfessional Basic Thermocycler can operate at 100, 115 or 230 Volt. The operation Voltage is shown on the Voltage selector which is located at the instrument bottom.

To change operation Voltage of the TProfessional Basic, switch off the instrument and disconnect the mains plug.

Use a coin or another round shape item to turn the adjustment slot of the Voltage selector to the new Voltage.

Instrument bottom

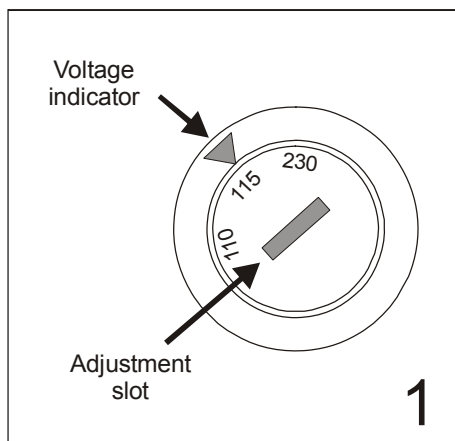

Instrument backside

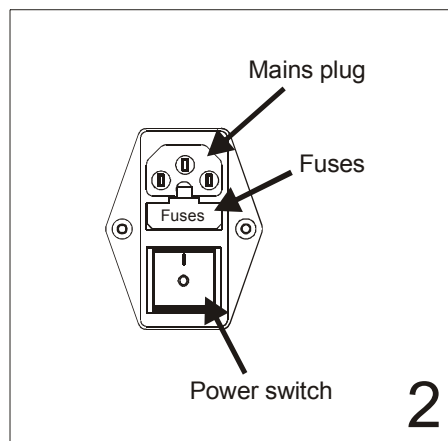

3.5 Initial self test (power on self test)

After switching on the TProfessional Basic serial number of the instrument and the software version is displayed.

A log file of the power on self test is stored in the Thermocycler memory (see section 6.4.1).

4 Operating elements

4.1 TProfessional Basic Thermocycler front view

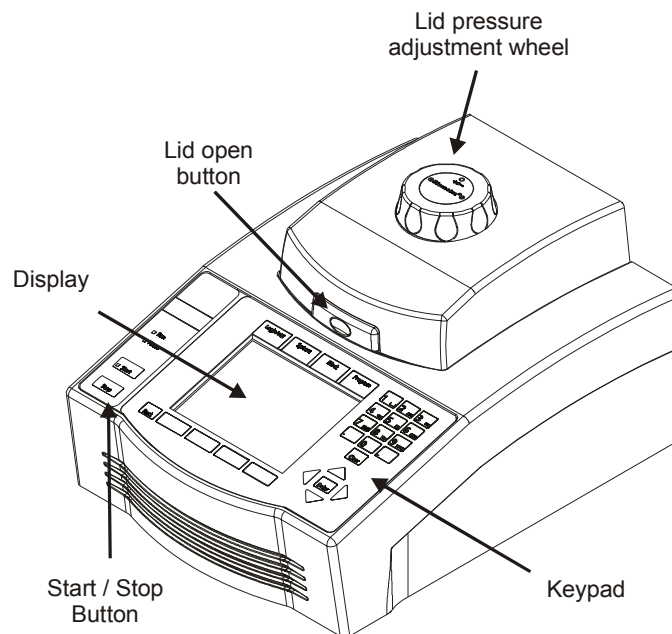

4.2 TProfessional Basic Thermocycler rear view

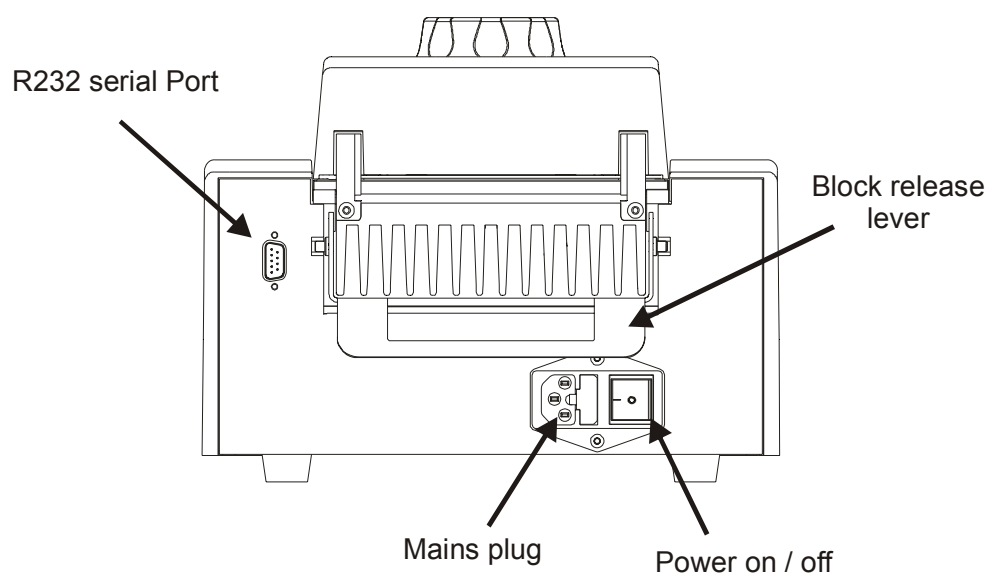

4.3 The TProfessional Basic control panel

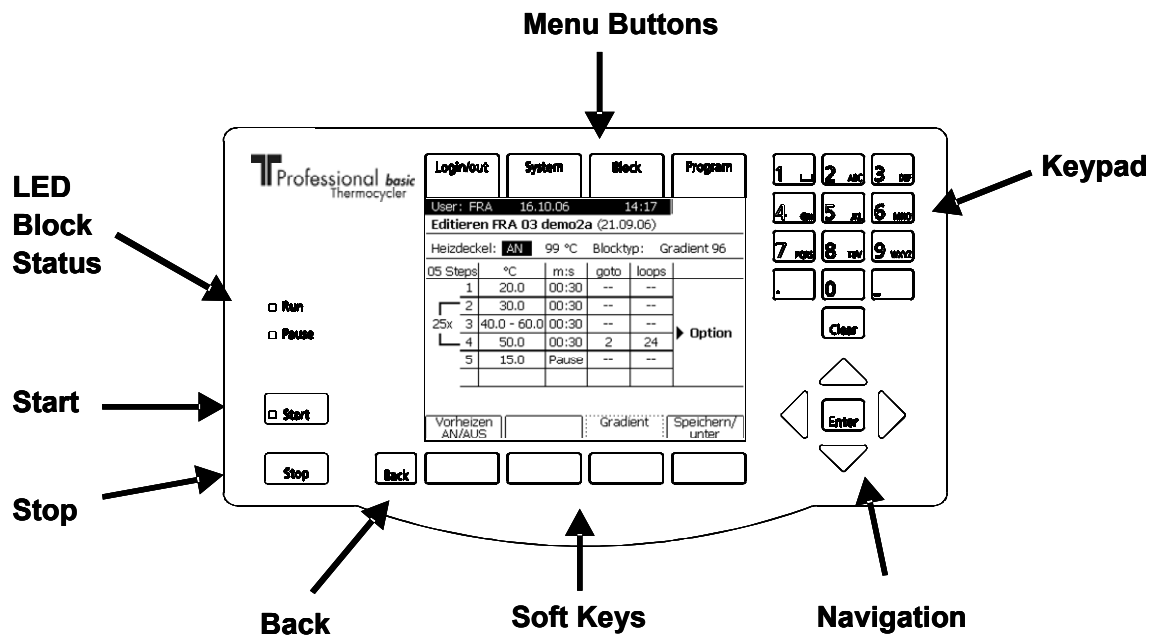

4.4 High Performance Smart Lid (HPSL)

To achieve optimum pressure on the tubes the TProfessional Basic is equipped with a height adjustable heated lid.

Close the lid:

After the samples have been placed in the block close the lid. Turn the wheel clockwise until you hear a clicking noise. In this mode the pressure will not increase further, even when you keep on turning the wheel.

Note: The pressure of the lid has been optimized for a fully loaded block. If only very few tubes are loaded to the block you should place two dummy tubes each in the four corner positions to avoid damage of tubes by excessive pressure.

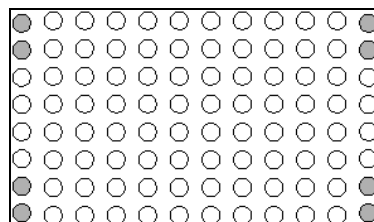

Open the lid:

First: Release pressure by turning the wheel counter clockwise. As soon as there is no more resistance the pressure has been released.

Then: Open the lid with by pushing the front button.

Important: The lid should not be opened under pressure because this leads to damage of the locking mechanism.

5 Operating

5.1 The TProfessional Basic User Interface

The TProfessional Basic User interface provides four **Menu Buttons** above the screen and four **Soft Keys** below the Screen,

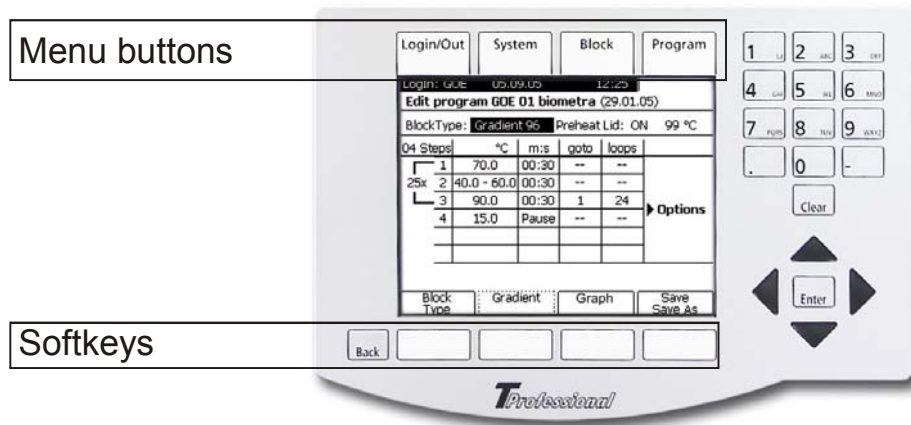

5.1.1 TProfessional Basic Menu Buttons

The four **MENU BUTTONS** allow quick access to the TProfessional Basic Main Menus. These are:

- Login /out Menu
- System Menu
- Block Menu
- Program Menu

The active menu is indicated by a graphical link to the respective menu button.

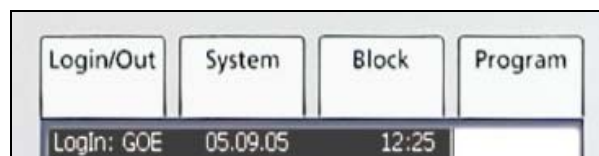

The example shows Program Menu is active.

The four **Menu Buttons** are permanent and always have the same function. This is in contrast to the **Soft Keys**. The Soft Key functions change depending on the current software menu.

5.1.2 TProfessional Basic Soft Keys

Below the Display there are four **SOFT KEYS**.

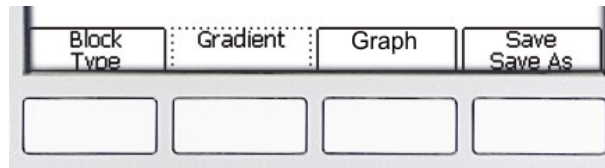

In contrast to the Menu Buttons, the Soft Keys have changing functionalities, which are shown in the above display line.

5.1.3 Log in Menu

To enter the Log In menu, press the Menu Button [Log in/out] above the display.

When the instrument is switched on, the Log in screen is displayed. To use the instrument a user has to be selected. Alternatively, a new user can be created.

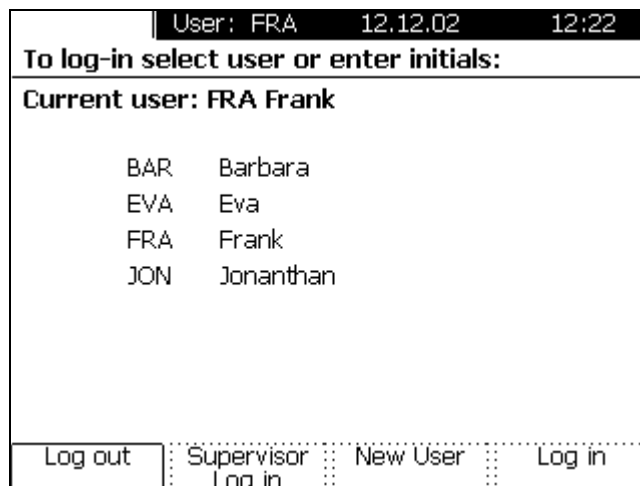

5.1.4 Block Menu

To enter the Block Menu, press the Menu Button [Block] above the display.

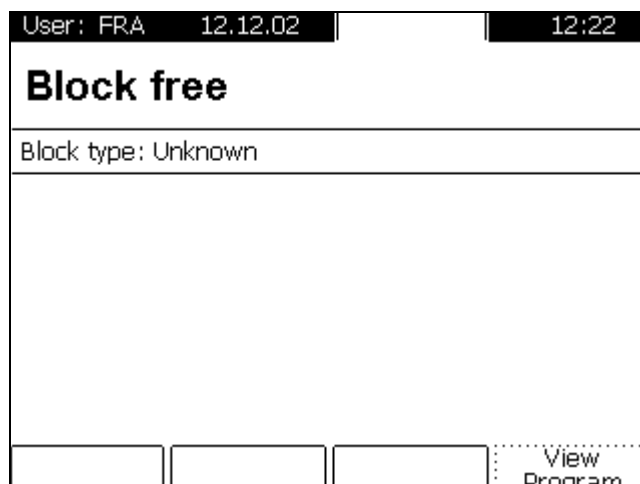

The block menu shows the current status of the block. The block can be active with a program or free.

If the block is free (not running), the five most recently used programs (by the active User) are listed. These programs can be started directly from the block menu (select with cursor and push [start] Button).

5.1.5 System Menu

To enter the System Menu, press the System Menu Button above the display.

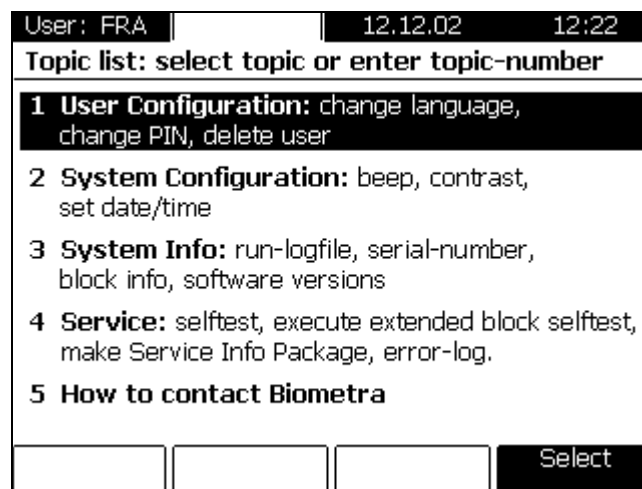

The System Menu allows global settings and provides information about the instrument. The power on self test log files can be retrieved and service files generated, a detailed description of this menu is shown in section 0, page 45.

5.1.6 Program Menu

To enter the Program Menu, press the Program Button above the Display.

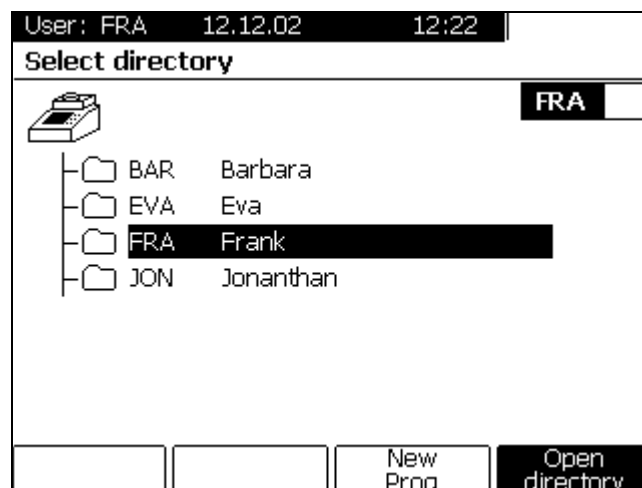

In the Program Menu, existing programs can be edited or new programs can be created. Each User has his own program directory, where individual programs are saved. Programs from other user directories can be used, but not modified.

5.2 TProfessional Basic Software

5.2.1 Navigation within software menus

Four navigation keys provide easy navigation within the software screens. The [left] and the [right] key have additional functionalities as described below:

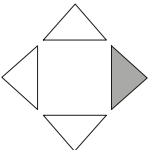
	<p>The right cursor key moves the cursor to the next field.</p> <p>This cursor can also be used to confirm data entry. By pressing the right cursor settings will be saved and the cursor moves to the next field.</p> <p>In the file directory, this key moves to cursor forward to the next (lower) level.</p>
---	--

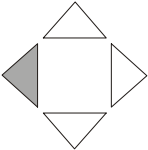
	<p>The left cursor key moves the cursor back to the previous field.</p> <p>In most screens this cursor is equivalent to the "back" key.</p> <p>In the file directory, this key moves the cursor back to the higher level.</p>
--	---

5.2.2 Log in

The TProfessional Basic manages up to 30 individual users. For each user a directory is created, where programs are stored. Programs from other directories (i.e. users) can be read but not modified. This allows to use all programs that are in the cyclor memory, but to write only in the own user directory.

Each User is identified by User Name plus Initials (2-3 letters).

Each User account can be protected by a PIN consisting of 1-7 digits. If no PIN protection is wanted, leave the field "Enter PIN" empty and confirm with [Enter].

Note: If no PIN protection is used, programs in the User directory may be changed or deleted by unauthorized persons.

5.2.3 Log in existing User

Press Menu Button [Log in/out] above the Display. A list of Users is shown

User: - - 12.12.02 12:22			
To log-in select user or enter initials:			
			BAR
BAR	Barbara		
EVA	Eva		
FRA	Frank		
JON	Jonathan		
Log out	Supervisor Log in	New User	Log in

Select User with cursor keys, or enter first initial. The cursor jumps to the first account starting with this letter.

User: - - 12.12.02 12:22			
To log-in select user or enter initials:			
			FRA
BAR	Barbara		
EVA	Eva		
FRA	Frank		
JON	Jonathan		
Log out	Supervisor Log in	New User	Log in

Press Soft Key [log in] and enter your PIN.

User: - - 12.12.02 12:22			
Enter 7 digit PIN code for: FRA Frank			

Remember to log-out when this cyclor is no longer under your supervision!			
			PIN-code OK

Confirm PIN with button [PIN code ok]. The current User is shown:

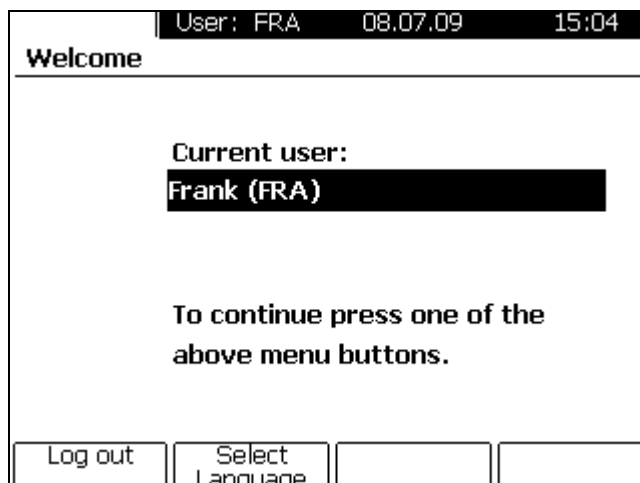

To proceed with editing or running a program, select one of the Menu Buttons above the display

5.2.4 Create new user account

Press Menu Button [Log in/out] above the Display.

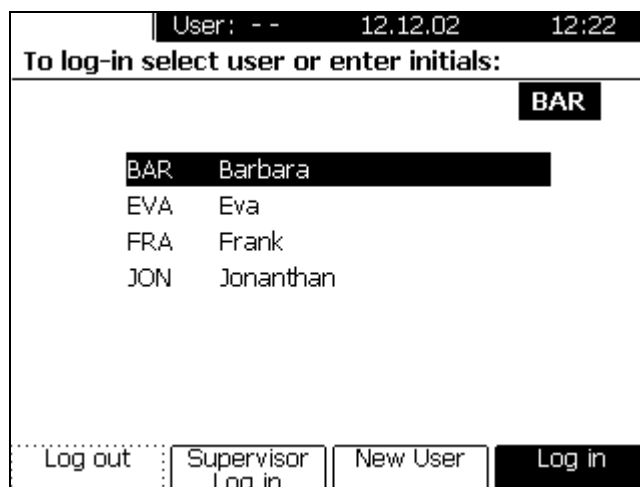

To create a new User account, press Soft Key [New User].

Enter your name and 2-3 initials. Enter a personal identification number (PIN) consisting of 1-7 digits. For security reasons, you are requested to repeat the entry of your PIN.

Note: PIN entry is optional. If no password protection is wanted, just confirm with [User data OK]. However, if no PIN is entered, your account containing all of your programs can be modified by unauthorized personnel.

Note: Your PIN can be changed any time in the System menu (see section 6.1.2).

5.2.5 Supervisor Log in

Only the Supervisor is authorized to change global instrument settings. This includes update of firmware and the deletion of user accounts.

To log in as Supervisor, press the Log in/out Menu Button above the Display. Press Soft Key [Supervisor Log in] and enter Supervisor PIN.

The default Supervisor PIN is 000 000 0 (do not enter blanks).

5.2.6 Delete User

Once logged in, you can delete your own account in the System Menu (see section 13.1.3.).

In addition, any user can be deleted by the Supervisor. To delete a user, log in as Supervisor (see section 6.3.) and select menu option “delete user”. Choose the user account you would like to delete and confirm with [OK].

Note: By deleting a User Account all programs in the referring user directory will be deleted. It is therefore recommended to save the programs in a different directory prior to deleting a User account.

5.3 Create program

At Thermocyclers of the TProfessional Basic series programs can be created in two ways. You may use pre-installed program examples (see chapter 5.3.1) or create new programs without a template (see chapter 5.3.2).

5.3.1 Create program from template

Log in to your personal user directory and press menu button [Program] above the display to enter the TProfessional Basic program menu. In the directory “Biometra Shared” you will find several pre-installed protocols for different PCR applications.

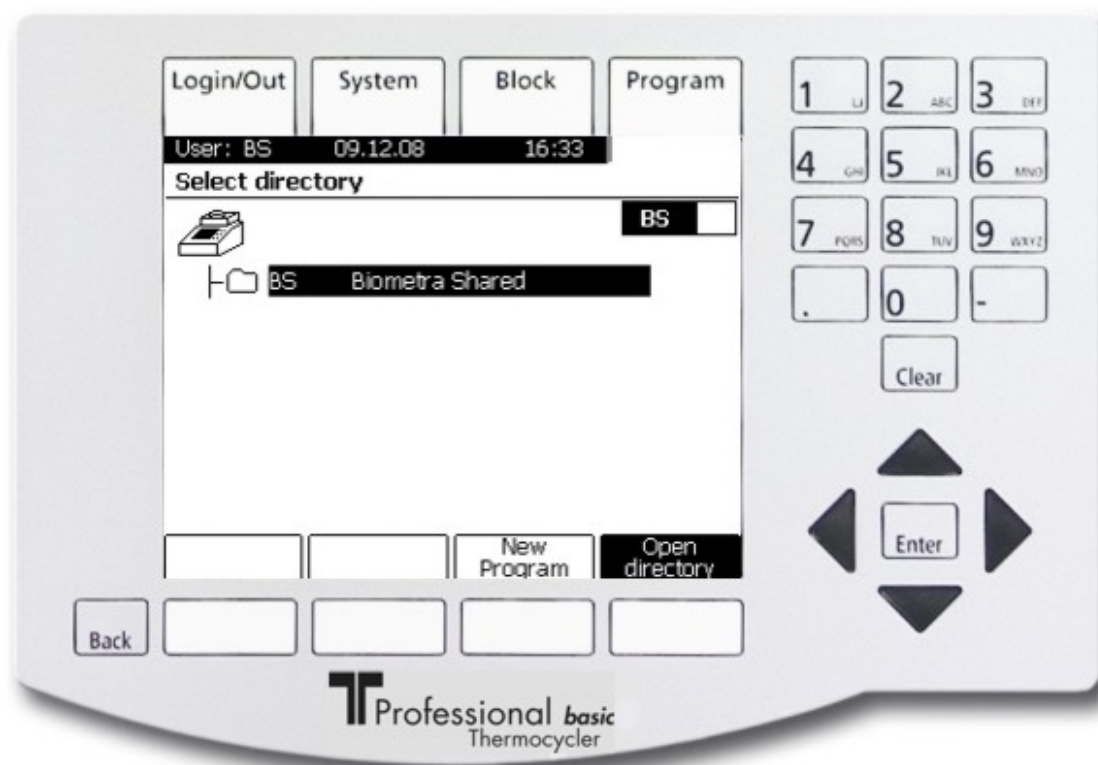

Press softkey [Open directory] to open the directory „Biometra Shared“. Choose a suitable program using the cursor keys or enter the corresponding program number. Protocols may be started directly from the Biometra Shared directory or may be copied to the respective user directory and edited (see chapter 5.3)

Note: Please always, before starting a template protocol, check the single steps and adapt details (times, temperatures, loops, temperature- and time-increments) according to the required PCR conditions respectively. Biometra will not be liable if the PCR does not work if necessary adjustments have not been programmed.

Note: The directory is protected by a PIN-Code. The default PIN for the directory “Biometra Shared” is 0000.

5.3.2 Create program without template

Press menu button [Program] above the display (see chapter 5.3.1) to enter the TProfessional Basic program menu.

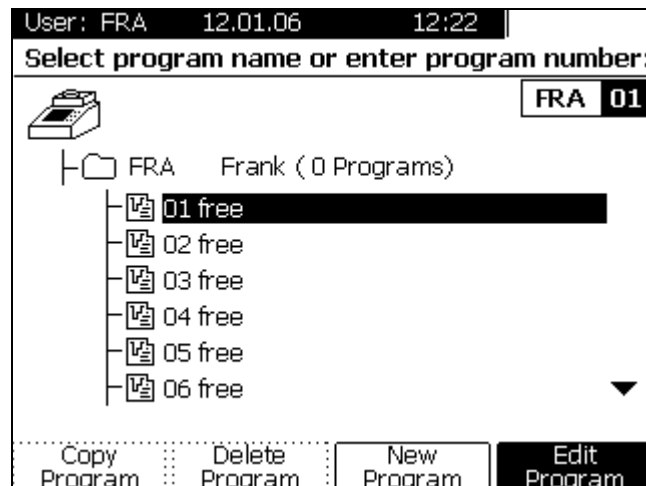

Press softkey [Edit Program] and in the next screen press [New Program].

The programming table opens (see chapter **Fehler! Verweisquelle konnte nicht gefunden werden.**).

5.3.3 Set lid pre-heating mode

You can choose whether the lid is pre-heated before the program starts. This is to avoid evaporation during the initial heating phase.

Note: During the preheating of the lid, the block is held constant at 25°C.

Note: After reaching the set lid temperature, there is a 40 second equilibration phase before the block starts.

Note: The default setting, which is recommended for most applications, is preheating: On.

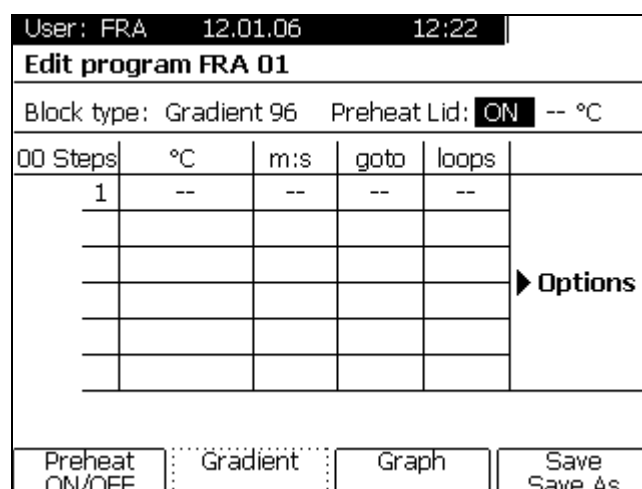

However, if the program should start while the lid is heating, this can be set by pressing the Soft Key [preheat on/off].

After Lid settings have been made, confirm with [Enter] to enter the programming spreadsheet.

5.3.4 Set lid temperature

Note: Thanks to the design of the new High Performance Smart Lid, lower lid temperatures can be used for thermocycling than in the past. Thanks to the lower lid temperature a higher temperature uniformity between samples can be achieved.

User: FRA 12.01.06 12:22					
Edit program FRA 01					
Block type: Gradient 96 Preheat Lid: ON 99 °C					
00 Steps	°C	m:s	goto	loops	
1	--	--	--	--	▶ Options
Insert/Delete Step		Gradient	Graph	Save Save As	

The recommended lid temperature is 99.0°C.

Enter temperature and confirm with [Enter] or step to the next field with cursor key.

5.3.5 Enter step temperature and time

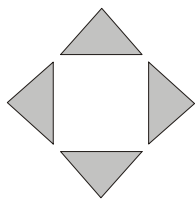

Use cursor keys to navigate in the programming table.

Note: Each setting is confirmed with [Enter]. The cursor moves automatically to the next field. Alternatively, you can confirm a value by moving forward with the cursor keys.

User: FRA 12.01.06 12:22					
Edit program FRA 01					
Block type: Gradient 96 Preheat Lid: ON 99 °C					
04 Steps	°C	m:s	goto	loops	
1	20.0	00:33	--	--	► Options
2	30.0	00:30	--	--	
3	40.0	00:30	--	--	
4	50.0	00:30	--	--	
Insert/Delete Step		Gradient	Graph	Save Save As	

Enter temperature for the first step and press [Enter]. In the next row you can enter the time for this temperature:

Note: Minutes and seconds can be separated by “dot”, but this is optional. You can also enter the digits one after the other.

Example: To set 2 minutes, 30 seconds enter “2”, “3”, “0”. Subsequently 2:30 [m:s] will be displayed in the programming table

Note: For Biometra Thermocyclers a dot can be used as a shortcut to program minutes.

Example: To set 2 minutes enter “2”, “.”. Subsequently 2:00 [m:s] will be displayed in the programming table

5.3.6 Set loop

Note: In general, loops are entered in the **LAST STEP** of the loop. A loop is defined by selecting the **FIRST STEP** in the loop plus the number of back loops.

Enter the number of the first step within the loop in the row “go to” and confirm with [Enter].

Enter the number of back loops in the row “loops”.

User: FRA 12.01.06 12:22					
Edit program FRA 01					
Block type: Gradient 96 Preheat Lid: ON 99 °C					
04 Steps	°C	m:s	goto	loops	
1	20.0	00:33	--	--	Options
┌ 2	30.0	00:30	--	--	
└ 25x 3	40.0	00:30	--	--	
┌ 4	50.0	00:30	2	24	
└ 5	--	--	--	--	
Insert/Delete: Gradient Graph Save Save As Step					

The loop is shown as a bracket at the left side of the spreadsheet.

Note: Total cycler number = (number of back loops) + 1, e.g. enter 24 for a total cycle number of 25.

5.3.7 Cool below ambient temperature

After the program has been finished, samples can be kept at below ambient temperature.

User: FRA 12.01.06 12:22					
Edit program FRA 01					
Block type: Gradient 96 Preheat Lid: ON 99 °C					
05 Steps	°C	m:s	goto	loops	
1	20.0	00:33	--	--	Options
┌ 2	30.0	00:30	--	--	
└ 25x 3	40.0	00:30	--	--	
┌ 4	50.0	00:30	2	24	
└ 5	15.0	Pause	--	--	
Insert/Delete: Gradient Graph Save Save As Step					

Note: To save lifetime of Peltier elements, a temperature of 15°C for the final step rather than 4°C is recommended.

5.3.8 Program Pause

To hold a temperature for an indefinite time enter "0". After confirming with [Enter] the word "pause" is shown.

5.3.9 Save program

Press button [Save / Save as].

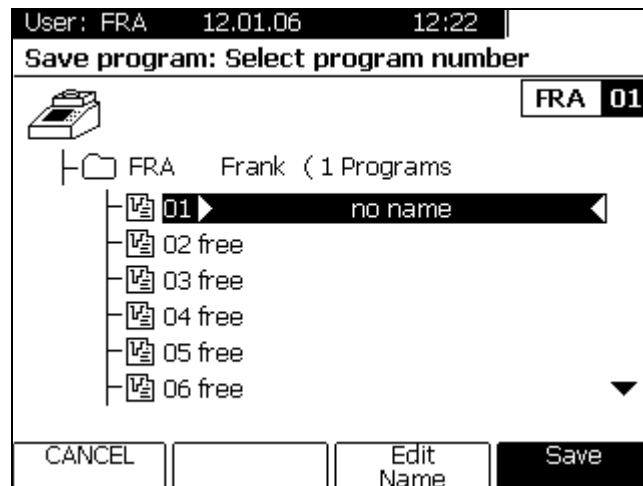

The first available program number is automatically pre-selected. Use cursor keys (or enter two digits) to move to a different program store.

To enter a program name press button [edit name].

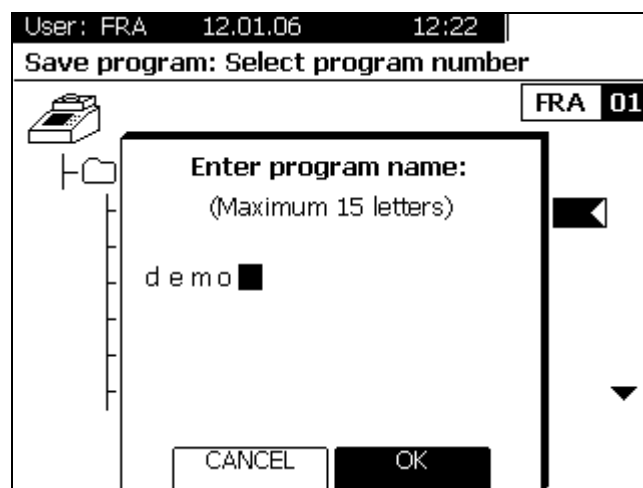

Enter program name and confirm name with button [ok].

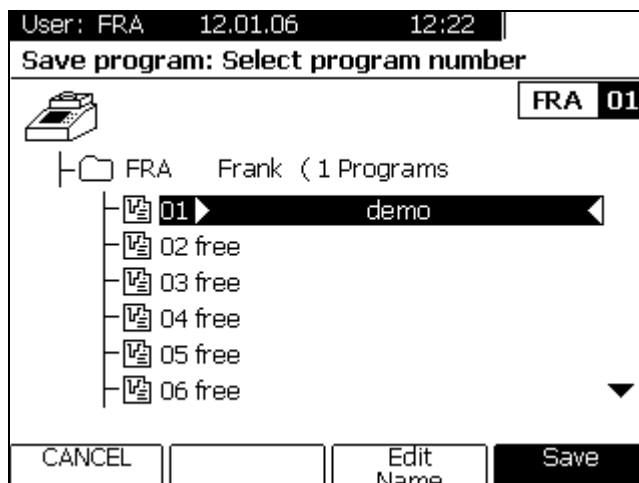

Confirm program store number with Soft Key [Save].



Program number, name and date are shown in the file directory.

To run this program press Menu Button [block] above the display.

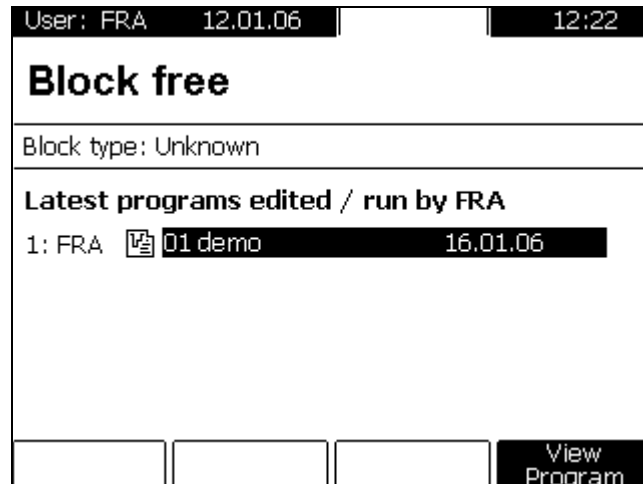

Press the (illuminated) [Start] Button on the left side of the keypad.

5.3.10 Set Gradient

The easiest way to define a gradient is to enter the two temperatures of the block (left and right side) separated by “-“.

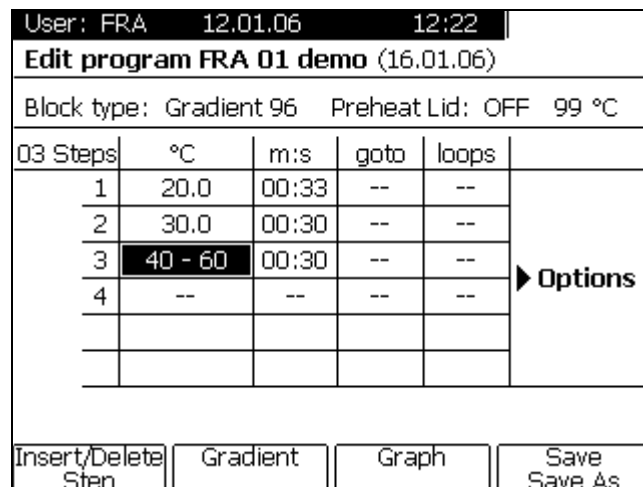

Confirm with [Enter] or move cursor to the next field.

Alternatively, move cursor to the field for temperature setting and press Soft Key [Gradient].

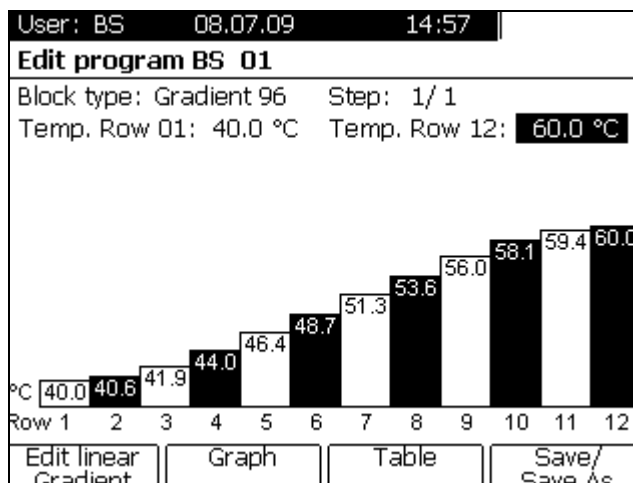

In the Gradient Screen you can enter a new, or edit an existing Gradient. Enter new settings for Row01 (left side) and Row12 (right side) and confirm with Enter.

After both settings are confirmed with [Enter] the temperatures for the single rows are displayed in the bar chart.

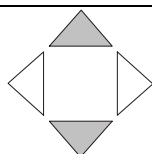

With the cursor keys UP and DOWN the gradient can be fine adjusted. Press the cursor keys to increase or decrease the temperature in increments of 0.1 °C.

To go back to the spreadsheet, press Soft Key [Table].

5.3.11 Program linear gradient

Press softkey [Edit linear gradient].

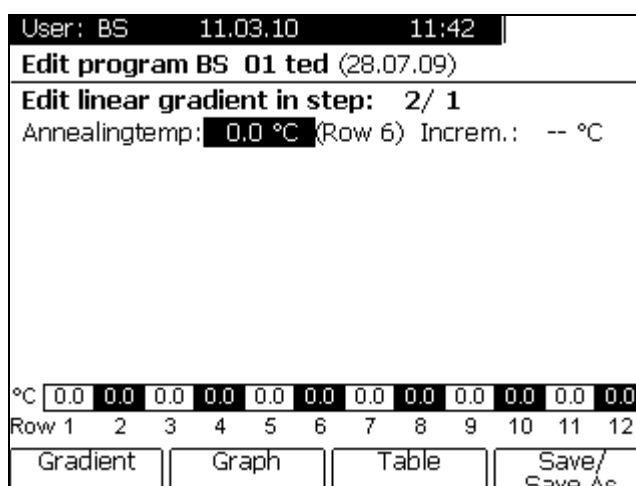

Enter the desired annealing temperature and define a temperature increment (Incr.) between the single rows of the heating block (E.g. the entered annealing temperature corresponds to the temperature in row 6 of a 96 well block). The temperatures for all other rows are calculated automatically. The temperature in row 01 (left side of the block) is the lowest and the temperature in row 12 (right side of the block) is the highest.

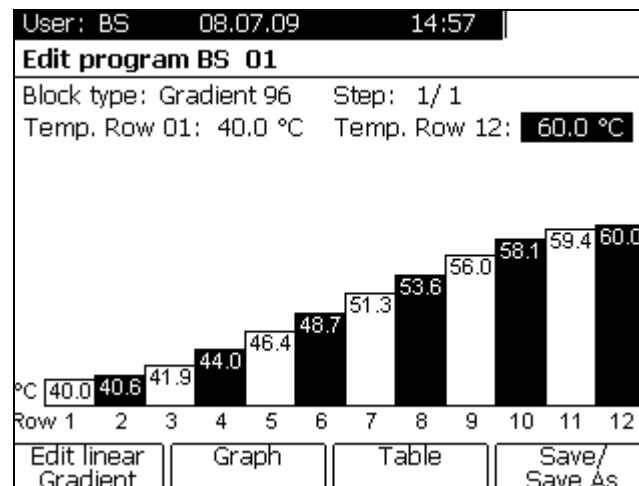

5.4 Edit programs

Programs can be edited in the Table or Graphical mode [Graph]. To change between these two modes click on the Soft Key [Table] or [Graph] respectively. The graphical mode is intended for easy modification of existing programs, which can then be saved under a new program number and name. To edit programs in the graphical mode see section 5.4.5, page 38.

Note: During operation of the Thermocycler the active program can be viewed but not modified. If you want to change settings of the active program for further experiments you have to save a copy of this program to another memory. For further information about copying programs see section 5.4.3, page 36.

5.4.1 Insert program step

Move cursor to the position, where a new step should be inserted

User: FRA 12.01.06 12:22

Edit program FRA 03 demo2a (16.01.06)

Block type: Gradient 96 Preheat Lid: OFF 99 °C

05 Steps	°C	m:s	goto	loops	
1	20.0	00:33	--	--	Options
2	30.0	00:30	--	--	
25x 3	40.0 - 60.0	00:30	--	--	
4	50.0	00:03	2	24	
5	15.0	Pause	--	--	

Insert/Delete Step Gradient Graph Save/Save As

To insert a program step press Soft Key [Insert/Del]. The step at which a new step will be inserted is highlighted.

User: FRA 12.01.06 12:22					
Edit program FRA 03 demo2a (16.01.06)					
Block type: Gradient 96 Preheat Lid: OFF 99 °C					
05 Steps	°C	m:s	goto	loops	
1	20.0	00:33	--	--	Options
2	30.0	00:30	--	--	
25x 3	40.0 - 60.0	00:30	--	--	
4	50.0	00:03	2	24	
5	15.0	Pause	--	--	
CANCEL			Delete Step	Insert Step	

Press Soft Key [insert step].

User: FRA 12.01.06 12:22					
Edit program FRA 03 demo2a (16.01.06)					
Block type: Gradient 96 Preheat Lid: ON 99 °C					
05 Steps	Insert step before step no 4?				Options
1					
2					
25x 3					
4					
5	NO		YES		

Confirm with Soft Key [Yes]. Enter temperature and time settings for new step.

User: FRA 12.01.06 12:22					
Edit program FRA 03 demo2a (16.01.06)					
Block type: Gradient 96 Preheat Lid: OFF 99 °C					
06 Steps	°C	m:s	goto	loops	
1	20.0	00:33	--	--	Options
2	30.0	00:30	--	--	
25x 3	40.0 - 60.0	00:30	--	--	
4	0.0	00:01	--	--	
5	50.0	00:03	2	24	
6	15.0	Pause	--	--	
Insert/Delete Step	Gradient	Graph	Save Save As		

Note: The new step has been entered within an existing loop, this loop now consists of four steps.

5.4.2 Delete program step

Move cursor to the step that should be deleted and press Soft Key [insert/delete step].

User: FRA 12.01.06 12:22					
Edit program FRA 03 demo2a (16.01.06)					
Block type: Gradient 96 Preheat Lid: OFF 99 °C					
06 Steps	°C	m:s	goto	loops	
1	20.0	00:33	--	--	Options
2	30.0	00:30	--	--	
3	40.0 - 60.0	00:30	--	--	
4	80.0	00:30	--	--	
5	50.0	00:03	2	24	
6	15.0	Pause	--	--	
CANCEL		Delete Step		Insert Step	

To delete the highlighted step press Soft Key [Insert/Del]

User: FRA 12.01.06 12:22					
Edit program FRA 03 demo2a (16.01.06)					
Block type: Gradient 96 Preheat Lid: ON 99 °C					
06 Steps	Delete step no 4?				
1					
2					
3					
4					
5					
6	Options				
NO		YES			

Confirm deletion of step number 4 with Soft Key [YES]

User: FRA 12.01.06 12:22					
Edit program FRA 03 demo2a (16.01.06)					
Block type: Gradient 96 Preheat Lid: OFF 99 °C					
05 Steps	°C	m:s	goto	loops	
1	20.0	00:33	--	--	Options
2	30.0	00:30	--	--	
25x 3	40.0 - 60.0	00:30	--	--	
4	50.0	00:03	2	24	
5	15.0	Pause	--	--	
Insert/Delete Step		Gradient	Graph	Save Save As	

The total step number is reduced by one, the loop now contains 3 steps only.

5.4.3 Copy program

Press Menu Button [Program] and enter User directory.

Move cursor to the program you want to copy.

User: FRA 12.01.06 12:22		
Select program name or enter program number:		
	FRA 02	
└─	FRA Frank (3 Programs)	
└─	01 demo	16.01.06
└─	02 demo1a	16.01.06
└─	03 demo2a	16.01.06 Grad
└─	04 free	
└─	05 free	
└─	06 free	
Copy Program		Delete Program
New Program		Edit Program

Press Soft Key [Copy Program]. The cursor automatically jumps to the next available (free) program store.

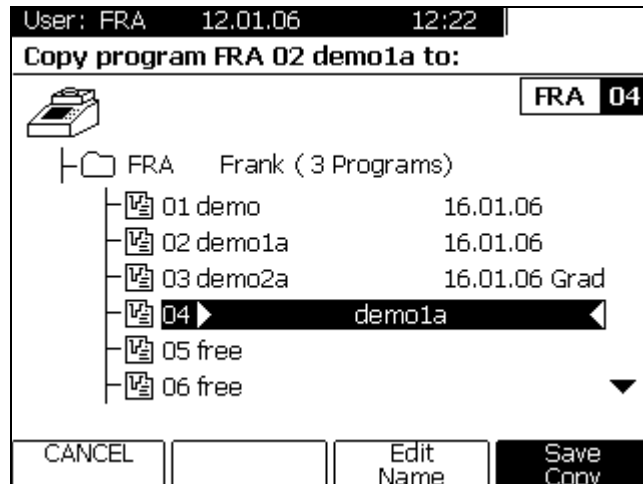

The program copy can be stored at any storage number. To change program number move the cursor to the wanted location or directly enter a storage number (two digits) over the keypad.

Edit name and confirm with Soft Key [Save Copy]

5.4.4 Delete program

Select a program from your user directory

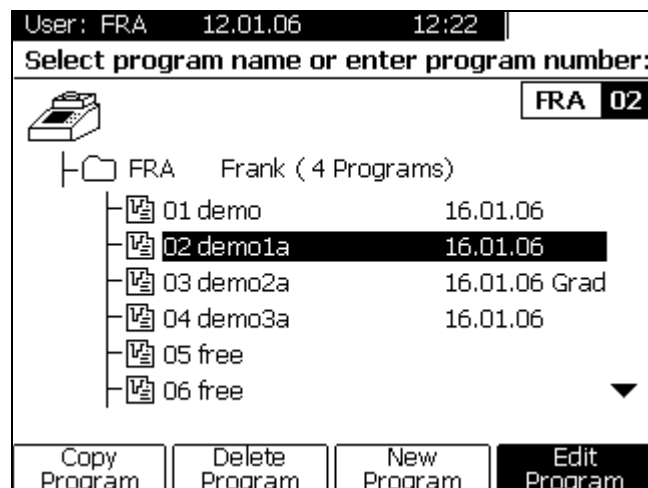

Press Soft Key [Delete program].

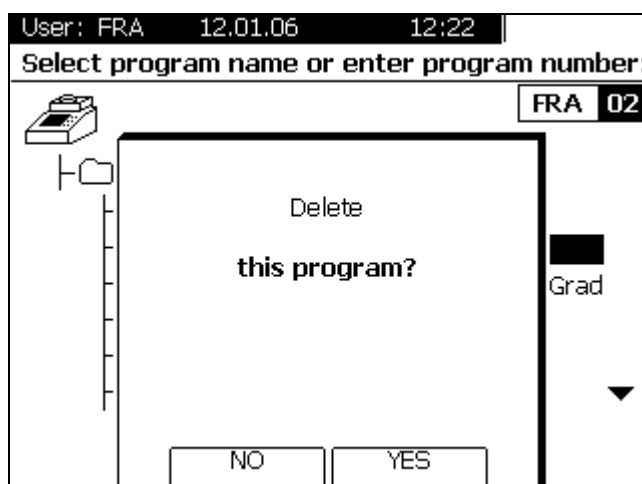

Confirm Deletion with Soft Key [Yes].

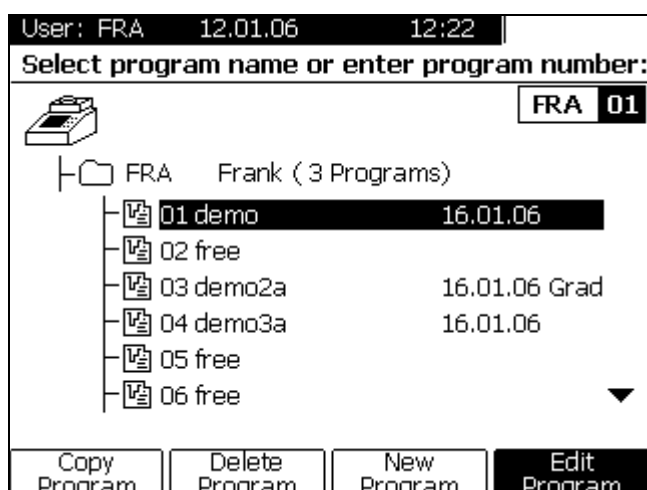

This program store is now free.

5.4.5 Editing programs in the graphical mode

Programs are created in the spread sheet mode where new steps are easily defined by Temperature and Time. In addition, programs can be edited in the graphical mode which provides a schematic temperature plot of the different steps.

To enter this mode, press Soft Key [Graph].

Spread Sheet Mode [Table]

Graphical Mode [Graph]

User: FRA 12.01.06 12:22					
Edit program FRA 03 demo2a (16.01.06)					
Block type: Gradient 96 Preheat Lid: OFF 99 °C					
05 Steps	°C	m:s	goto	loops	
1	20.0	00:33	--	--	Options
2	30.0	00:30	--	--	
25x 3	40.0 - 60.0	00:30	--	--	
4	50.0	00:03	2	24	
5	15.0	Pause	--	--	
Insert/Delete Step	Gradient	Graph	Save Save As		

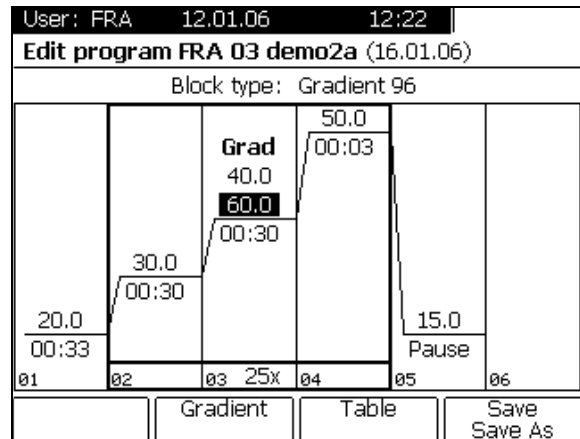

To change temperature and time settings, move cursor to the respective field and enter new values with the key pad. Once confirmed with enter, the temperature graph is updated.

Note: The steps are automatically spread over the whole range to give maximum resolution (thus steps height does not represent the real temperature).

Note: To set loops, go to the Spread Sheet Mode (press [Table])

Note: To insert or delete program steps, go to the Spread Sheet Mode (press [Table])

Note: To edit or enter gradients, move cursor to the respective step and press Soft Key [Gradient]. Enter gradient temperatures as described in section 5.3.10, page 31).

5.5 Change program options

For each step additional options can be defined.

To change program options, move the cursor to the right side of the spreadsheet, labelled with "Options". A new table is displayed.

User: FRA 12.01.06 12:22					
Edit program FRA 03 demo2a (16.01.06)					
Block type: Gradient 96 Preheat Lid: OFF 99 °C					
05 Steps	°C	m:s	goto	loops	
1	20.0	00:33	--	--	Options
2	30.0	00:30	--	--	
25x 3	40.0 - 60.0	00:30	--	--	
4	50.0	00:03	2	24	
5	15.0	Pause	--	--	
Insert/Delete Step	Gradient	Graph	Save Save As		

User: FRA 12.01.06 12:22					
Edit program FRA 03 demo2a (16.01.06)					
Block type: Gradient 96 Preheat Lid: OFF 99 °C					
05 Steps	°C	m:s	ΔT(°C)	Δt (s)	λ(°C/s)
1	20.0	00:33	--	--	5.0
2	30.0	00:30	--	--	5.0
25x 3	40.0 - 60.0	00:30	--	--	5.0
4	50.0	00:03	--	--	5.0
5	15.0	Pause	--	--	5.0
Insert/Delete Step	Gradient	Graph	Save Save As		

To go back to programming sheet, move the cursor to the left side of the display

User: FRA 12.01.06 12:22					
Edit program FRA 03 demo2a (16.01.06)					
Block type: Gradient 96 Preheat Lid: OFF 99 °C					
05 Steps	°C	m:s	goto	loops	
1	20.0	00:33	--	--	Options +
2	30.0	00:30	--	--	
25x 3	40.0 - 60.0	00:30	--	--	
4	50.0	00:03	2	24	
5	15.0	Pause	--	--	
Insert/Delete Step		Gradient	Graph	Save Save As	

If options have been changed from the default values, there is an indication in the options field.

5.5.1 Heating and cooling rate

Since the TProfessional Basic is a fast thermocycler it may be necessary to reduce the heating and cooling ramp to adapt protocols from slower thermocyclers.

The average heating and cooling rates can be set in the column labelled with \uparrow [°C/s].

User: HD 11.09.09 16:40						
Edit program HD 01						
Preheat Lid: ON 99 °C Block type: Gradient 96						
06 Steps	°C	m:s		ΔT (°C)	Δt (s)	\uparrow (°C/s)
1	95.0	05:00		--	--	3.0
2	95.0	00:30		--	--	3.0
3	58.0	00:30		--	--	3.0
4	72.0	00:30		--	--	3.0
5	72.0	05:00		--	--	3.0
6	16.0	Pause		--	--	3.0
Insert/Delete Step		Gradient	Graph	Save/ Save As		

Note: This entry specifies the speed at which the referring step is achieved. I.e. to heat from step 1 to step 2, the heating rate in step 2 has to be lowered.

Note: To reduce the over all speed of the Thermocycler, the heating rate has to be modified in all steps. The speed settings will be only valid for this individual program.

5.5.2 Time increment $\rightarrow \Delta t(s)$

To compensate for loss in enzyme activity, each step within a loop can be extended from cycle to cycle. Enter the desired time increment [seconds] in the row labelled with dt[s]. This value will be added to the time value from cycle to cycle.

$\Delta T (^{\circ}\text{C})$	$\Delta t (\text{s})$	$\lambda (^{\circ}\text{C}/\text{s})$
--	--	3.0
--	--	3.0
←	5	3.0
--	--	3.0
--	--	3.0
--	--	3.0

Note: A time increment will increase the total runtime depending on the numbers of cycles and the size of the increment. A program with many cycles and large time increments will take a significantly longer time than a standard protocol.

5.5.3 Temperature increment or decrement → $\Delta T (^{\circ}\text{C})$

For some applications it is useful to start with a higher temperature and to decrease this temperature from cycle to cycle. This subsequent lowering of a temperature is called touch down.

$\Delta T (^{\circ}\text{C})$	$\Delta t (\text{s})$	$\lambda (^{\circ}\text{C}/\text{s})$
--	--	3.0
--	--	3.0
←	-0.1	3.0
--	--	3.0
--	--	3.0
--	--	3.0

To decrease a temperature from cycle to cycle enter a negative temperature increment in the row labelled with $\Delta T [^{\circ}\text{C}]$.

Note: Be sure that the temperature decrease is set in a step that lies within a loop. Otherwise there will be no iterative temperature decrease.

5.6 Run program

To start program press [Start] Button (see section 4.3, page 15).

This button is only active, when a program for start has been selected. This is indicated by the green LED in the Start button.

5.6.1 Select program for start from User directories

Any program in the cycler memory can be used to start the thermocycler. In addition to the programs in the own User account, also programs from other User directories can be started.

To select a program for start press [Program] Menu Button above the Display.

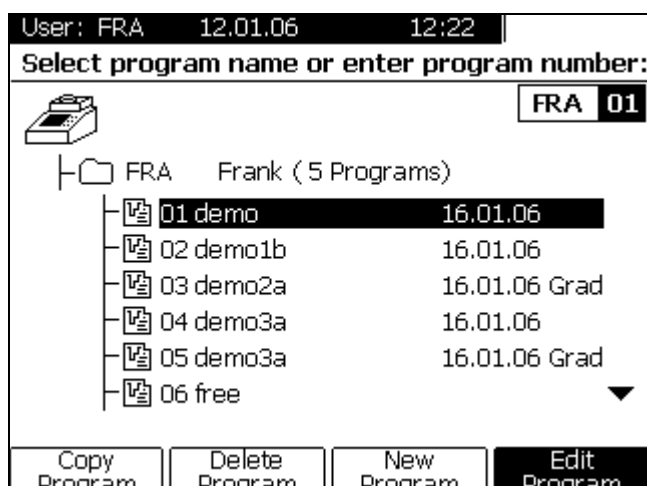

Select directory and program with cursor keys and press [Start] Button.

5.6.2 Quick start programs from the block Menu

The TProfessional Basic provides the last 5 programs that haven been run for quick start.

Push the [block] Menu Button above the Display.



Select one of the last five programs with the cursor keys.

Press the (illuminated) Start button on the left side of the keypad (see section 4.3, page 15).

5.6.3 View program prior to start

To check the program prior to start press the [View Program] Soft Key.

User: FRA		12.01.06		12:22	
View program FRA 02 demo1b (16.01.06)					
Block type: Gradient 96 Preheat Lid: ON 99 °C					
05 Steps	°C	m:s	goto	loops	
1	20.0	00:30	--	--	Options
2	30.0	00:30	--	--	
25x 3	40.0	00:30	--	--	
4	50.0	00:30	2	24	
5	15.0	Pause	--	--	
Run Time: 45m					
View Gradient		View Graph		Copy Program	

The current program is shown.

Press [View Graph] Soft Key for alternative display.

View Table

User: FRA		12.01.06		12:22	
View program FRA 02 demo1b (16.01.06)					
Block type: Gradient 96 Preheat Lid: ON 99 °C					
05 Steps	°C	m:s	goto	loops	
1	20.0	00:30	--	--	Options
2	30.0	00:30	--	--	
25x 3	40.0	00:30	--	--	
4	50.0	00:30	2	24	
5	15.0	Pause	--	--	
Run Time: 45m					
View Gradient		View Graph		Copy Program	

View Graph

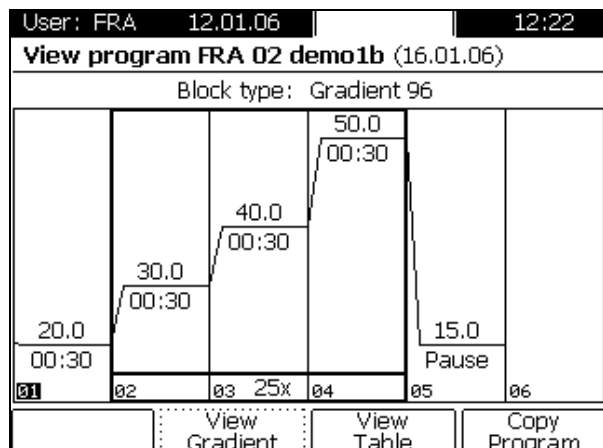

Note: In the view program mode, a program cannot be edited. To edit program press [Program] Menu Button above the Display.

5.6.4 Display during operation

After the instrument has been started, the below display is shown

User: FRA		12.01.06		12:22	
Block active		Program FRA / 02 demo1b			
User: Frank (FRA) Block type: Gradient 96					
<p>Remaining Time: 1h 22m Estimated End : 4:22 pm</p>					
Pause Block	Show Grad	Show Graph	Show Table		

To show detailed information about the running program, press one of the Soft Keys [Show Graph] and [Show Table].

There are three different display modes available during the run.

Show Time	Show Graph	Show Table																																																																																																																																																			
<table border="1"> <tr> <td colspan="2">User: FRA</td> <td colspan="2">12.01.06</td> <td colspan="2">12:22</td> </tr> <tr> <td colspan="2">Block active</td> <td colspan="4">Program FRA / 02 demo1b</td> </tr> <tr> <td colspan="6">User: Frank (FRA) Block type: Gradient 96</td> </tr> <tr> <td colspan="6" style="text-align: center;"> <p>Remaining Time: 1h 22m Estimated End : 4:22 pm</p> </td> </tr> <tr> <td>Pause Block</td> <td>Show Grad</td> <td>Show Graph</td> <td>Show Table</td> <td colspan="2"></td> </tr> </table>	User: FRA		12.01.06		12:22		Block active		Program FRA / 02 demo1b				User: Frank (FRA) Block type: Gradient 96						<p>Remaining Time: 1h 22m Estimated End : 4:22 pm</p>						Pause Block	Show Grad	Show Graph	Show Table			<table border="1"> <tr> <td colspan="2">User: FRA</td> <td colspan="2">12.01.06</td> <td colspan="2">12:22</td> </tr> <tr> <td colspan="2">Block active</td> <td colspan="4">Program FRA / 02 demo1b</td> </tr> <tr> <td colspan="6">Block: 20.0 °C Step: 01/05</td> </tr> <tr> <td colspan="6"> </td> </tr> <tr> <td colspan="6"> <table border="1"> <thead> <tr> <th>Time</th> <th>Temp (°C)</th> <th>Time</th> </tr> </thead> <tbody> <tr> <td>01:15</td> <td>20.0</td> <td>01:15</td> </tr> <tr> <td>02</td> <td>30.0</td> <td>00:30</td> </tr> <tr> <td>03</td> <td>40.0</td> <td>00:30</td> </tr> <tr> <td>04</td> <td>50.0</td> <td>00:30</td> </tr> <tr> <td>05</td> <td>15.0</td> <td>Pause</td> </tr> <tr> <td>06</td> <td></td> <td></td> </tr> </tbody> </table> </td> </tr> <tr> <td colspan="3">Estimated End:</td> <td colspan="3">Lid: 99.0 °C</td> </tr> <tr> <td>Pause Block</td> <td>Show Grad</td> <td>Show Time</td> <td>Show Table</td> <td colspan="2"></td> </tr> </table>	User: FRA		12.01.06		12:22		Block active		Program FRA / 02 demo1b				Block: 20.0 °C Step: 01/05												<table border="1"> <thead> <tr> <th>Time</th> <th>Temp (°C)</th> <th>Time</th> </tr> </thead> <tbody> <tr> <td>01:15</td> <td>20.0</td> <td>01:15</td> </tr> <tr> <td>02</td> <td>30.0</td> <td>00:30</td> </tr> <tr> <td>03</td> <td>40.0</td> <td>00:30</td> </tr> <tr> <td>04</td> <td>50.0</td> <td>00:30</td> </tr> <tr> <td>05</td> <td>15.0</td> <td>Pause</td> </tr> <tr> <td>06</td> <td></td> <td></td> </tr> </tbody> </table>						Time	Temp (°C)	Time	01:15	20.0	01:15	02	30.0	00:30	03	40.0	00:30	04	50.0	00:30	05	15.0	Pause	06			Estimated End:			Lid: 99.0 °C			Pause Block	Show Grad	Show Time	Show Table			<table border="1"> <tr> <td colspan="2">User: FRA</td> <td colspan="2">12.01.06</td> <td colspan="2">12:22</td> </tr> <tr> <td colspan="2">Block active</td> <td colspan="4">Program FRA / 02 demo1b</td> </tr> <tr> <td colspan="6">20.0 °C</td> </tr> <tr> <td colspan="6"> <table border="1"> <thead> <tr> <th>05 Steps</th> <th>°C</th> <th>m:s</th> </tr> </thead> <tbody> <tr> <td>1</td> <td>20.0</td> <td>01:14</td> </tr> <tr> <td>2</td> <td>30.0</td> <td>00:30</td> </tr> <tr> <td>3</td> <td>40.0</td> <td>00:30</td> </tr> <tr> <td>4</td> <td>50.0</td> <td>00:30</td> </tr> <tr> <td>5</td> <td>15.0</td> <td>Pause</td> </tr> </tbody> </table> </td> </tr> <tr> <td colspan="3">Estimated End:</td> <td colspan="3">Lid: 99.0 °C</td> </tr> <tr> <td>Pause Block</td> <td>Show Grad</td> <td>Show Graph</td> <td>Show Time</td> <td colspan="2"></td> </tr> </table>	User: FRA		12.01.06		12:22		Block active		Program FRA / 02 demo1b				20.0 °C						<table border="1"> <thead> <tr> <th>05 Steps</th> <th>°C</th> <th>m:s</th> </tr> </thead> <tbody> <tr> <td>1</td> <td>20.0</td> <td>01:14</td> </tr> <tr> <td>2</td> <td>30.0</td> <td>00:30</td> </tr> <tr> <td>3</td> <td>40.0</td> <td>00:30</td> </tr> <tr> <td>4</td> <td>50.0</td> <td>00:30</td> </tr> <tr> <td>5</td> <td>15.0</td> <td>Pause</td> </tr> </tbody> </table>						05 Steps	°C	m:s	1	20.0	01:14	2	30.0	00:30	3	40.0	00:30	4	50.0	00:30	5	15.0	Pause	Estimated End:			Lid: 99.0 °C			Pause Block	Show Grad	Show Graph	Show Time		
User: FRA		12.01.06		12:22																																																																																																																																																	
Block active		Program FRA / 02 demo1b																																																																																																																																																			
User: Frank (FRA) Block type: Gradient 96																																																																																																																																																					
<p>Remaining Time: 1h 22m Estimated End : 4:22 pm</p>																																																																																																																																																					
Pause Block	Show Grad	Show Graph	Show Table																																																																																																																																																		
User: FRA		12.01.06		12:22																																																																																																																																																	
Block active		Program FRA / 02 demo1b																																																																																																																																																			
Block: 20.0 °C Step: 01/05																																																																																																																																																					
<table border="1"> <thead> <tr> <th>Time</th> <th>Temp (°C)</th> <th>Time</th> </tr> </thead> <tbody> <tr> <td>01:15</td> <td>20.0</td> <td>01:15</td> </tr> <tr> <td>02</td> <td>30.0</td> <td>00:30</td> </tr> <tr> <td>03</td> <td>40.0</td> <td>00:30</td> </tr> <tr> <td>04</td> <td>50.0</td> <td>00:30</td> </tr> <tr> <td>05</td> <td>15.0</td> <td>Pause</td> </tr> <tr> <td>06</td> <td></td> <td></td> </tr> </tbody> </table>						Time	Temp (°C)	Time	01:15	20.0	01:15	02	30.0	00:30	03	40.0	00:30	04	50.0	00:30	05	15.0	Pause	06																																																																																																																													
Time	Temp (°C)	Time																																																																																																																																																			
01:15	20.0	01:15																																																																																																																																																			
02	30.0	00:30																																																																																																																																																			
03	40.0	00:30																																																																																																																																																			
04	50.0	00:30																																																																																																																																																			
05	15.0	Pause																																																																																																																																																			
06																																																																																																																																																					
Estimated End:			Lid: 99.0 °C																																																																																																																																																		
Pause Block	Show Grad	Show Time	Show Table																																																																																																																																																		
User: FRA		12.01.06		12:22																																																																																																																																																	
Block active		Program FRA / 02 demo1b																																																																																																																																																			
20.0 °C																																																																																																																																																					
<table border="1"> <thead> <tr> <th>05 Steps</th> <th>°C</th> <th>m:s</th> </tr> </thead> <tbody> <tr> <td>1</td> <td>20.0</td> <td>01:14</td> </tr> <tr> <td>2</td> <td>30.0</td> <td>00:30</td> </tr> <tr> <td>3</td> <td>40.0</td> <td>00:30</td> </tr> <tr> <td>4</td> <td>50.0</td> <td>00:30</td> </tr> <tr> <td>5</td> <td>15.0</td> <td>Pause</td> </tr> </tbody> </table>						05 Steps	°C	m:s	1	20.0	01:14	2	30.0	00:30	3	40.0	00:30	4	50.0	00:30	5	15.0	Pause																																																																																																																														
05 Steps	°C	m:s																																																																																																																																																			
1	20.0	01:14																																																																																																																																																			
2	30.0	00:30																																																																																																																																																			
3	40.0	00:30																																																																																																																																																			
4	50.0	00:30																																																																																																																																																			
5	15.0	Pause																																																																																																																																																			
Estimated End:			Lid: 99.0 °C																																																																																																																																																		
Pause Block	Show Grad	Show Graph	Show Time																																																																																																																																																		

5.6.5 Pause Program during run

To pause program press Soft Key [Pause Block].

User: FRA		12.01.06		12:22																			
Pause		Program FRA / 02 demo1b																					
20.0 °C																							
<table border="1"> <thead> <tr> <th>05 Steps</th> <th>°C</th> <th>m:s</th> </tr> </thead> <tbody> <tr> <td>1</td> <td>20.0</td> <td>01:13</td> </tr> <tr> <td>2</td> <td>30.0</td> <td>00:30</td> </tr> <tr> <td>3</td> <td>40.0</td> <td>00:30</td> </tr> <tr> <td>4</td> <td>50.0</td> <td>00:30</td> </tr> <tr> <td>5</td> <td>15.0</td> <td>Pause</td> </tr> </tbody> </table>						05 Steps	°C	m:s	1	20.0	01:13	2	30.0	00:30	3	40.0	00:30	4	50.0	00:30	5	15.0	Pause
05 Steps	°C	m:s																					
1	20.0	01:13																					
2	30.0	00:30																					
3	40.0	00:30																					
4	50.0	00:30																					
5	15.0	Pause																					
Estimated End:			Lid: 99.0 °C																				
Continue	Show Grad	Show Graph	Show Time																				

The message “PAUSE” is shown in the display and alternates with the elapsed time.

5.6.6 Continue program

To continue paused program press Soft Key [Continue]

5.7 Stop program

To stop the active program press [stop] Button.

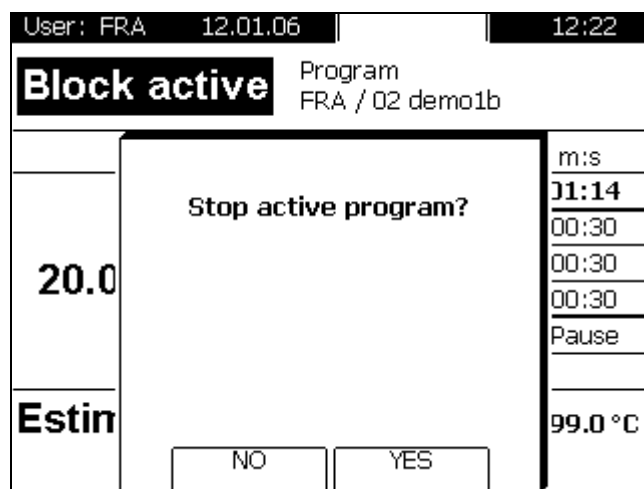

To abort the active program confirm with [Yes].

5.7.1 Stop Program from a pause

If the last step in a program is a pause, the program has to be stopped by pressing the [Stop] Button before switching off the instrument.

Note: If the instrument is switched off during a pause step, this will be recognized as a power failure (a referring error message is written to the log file).

5.8 Optimization of Fast-PCR programs

The usage of Fast-PCR Kits allows a significant shortening of PCR protocols in comparison to normal programs when conventional polymerases are used. Though suppliers of Fast-PCR kits suggest some protocols for their polymerases for the optimization of Fast-PCR protocols some physical factors have to be considered. E.g. the temperature transfer from the thermocycler block into the reaction mix is hindered by low temperature conductivity of the plastic of the reaction tubes. Moreover the temperature spread within the block, especially at short dwells, depends on its geometry and is different between various block types. To reach the desired temperature in the reaction tube, when dwells are shortened (≤ 15 sec), the target temperature of program steps has to be adapted, otherwise drop-outs due to insufficient denaturation or insufficient primer annealing may occur. Biometra recommends the following protocol templates for the optimization of dwells for the TProfessional Basic Thermocycler:

Dwell 15sec, Annealing temperature 60 °C

95 °C	5:00	
96 °C	00:15	35x
59 °C	00:15	
68 °C	00:30	
72 °C	01:00	
16 °C	Pause	

Dwell 5sec, Annealing temperature 60 °C

95 °C	5:00	
97,5 °C	00:05	35x
57,5 °C	00:05	
68 °C	00:30	
72 °C	01:00	
16 °C	Pause	

Dwell 10sec, Annealing temperature 60 °C

95 °C	5:00	
96,5 °C	00:10	35x
58,5 °C	00:10	
68 °C	00:30	
72 °C	01:00	
16 °C	Pause	

Dwell 1sec, Annealing temperature 60 °C

95 °C	5:00	
99 °C	00:01	35x
56 °C	00:01	
68 °C	00:30	
72 °C	01:00	
16 °C	Pause	

The protocol templates are pre-installed in the directory “Biometra Shared” (see chapter 5.3.1).

Note: The given annealing temperatures correspond to a calculated primer annealing temperature of 60°C. If necessary, the annealing temperature has to be optimised for each single primer pair. Biometra recommends to optimize the annealing temperature by a gradient at 0.5 °C steps on a gradient enabled PCR Thermocycler.

Note: For the protocol templates an elongation time of 30 sec each is given. For optimisation of the elongation time please take the processivity (bases/sec) of the Fast-PCR polymerase given in the supplier handbook into consideration and adjust the elongation time corresponding to the length of the fragment to be amplified. At a processivity of 35 bp/sec the elongation time given in the protocol templates would be sufficient for the amplification of a 1000 bp long DNA fragment.

Note: The proposed protocols are only applicable for the Thermocycler TProfessional Basic 96. To establish a Fast-PCR at the Thermocyclers TProfessional 96 and TProfessional Standard 96 please follow the instructions in the homologue chapter of the corresponding manual.

6 System settings

To change global settings press the [System] Menu Button above the screen.

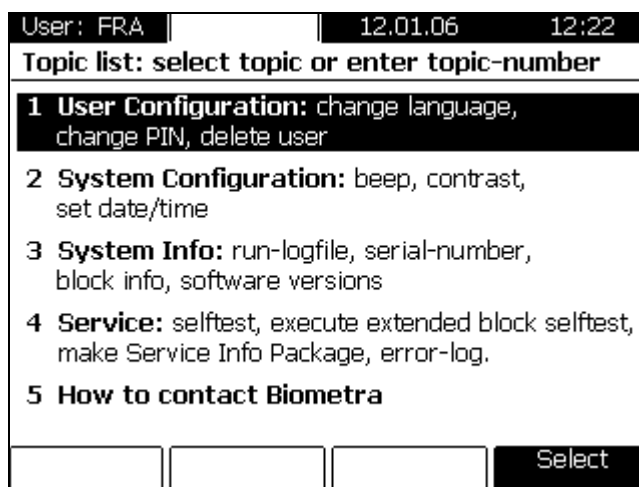

Main screen

6.1 User configuration

This option allows changes of your individual user account.

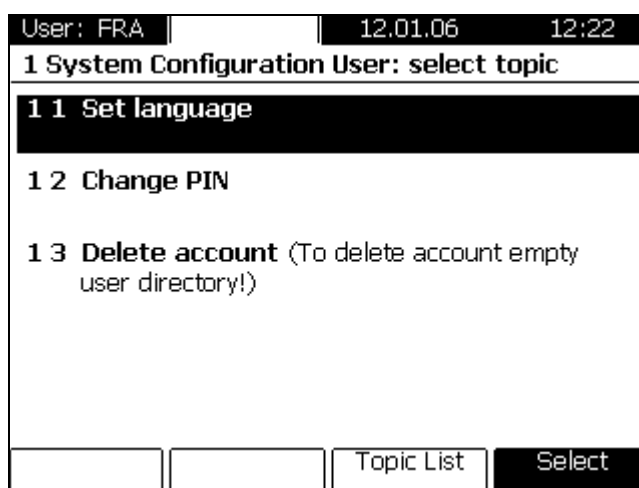

6.1.1 Set language

The language settings are part of each User account. Available languages are English and German (second software release)

6.1.2 Change individual PIN

The option allows changing the PIN of the current User.

6.1.3 Delete Account

Any user can delete his or her personal account.

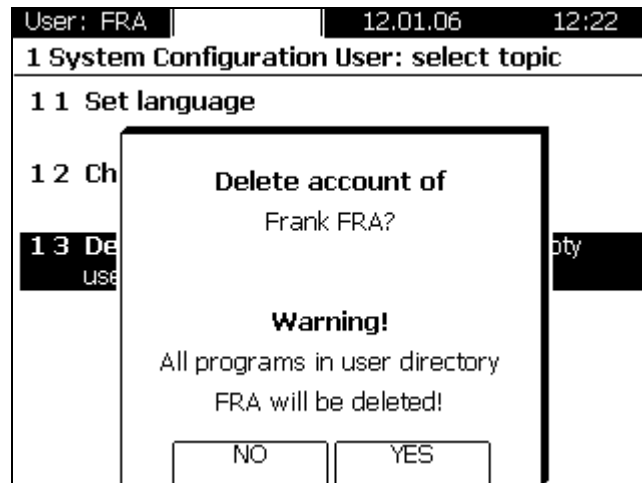

Important: Deleting a User account will automatically delete the user file directory together with all programs stored in this directory.

Prior to deleting an account, ensure that the User directory is empty, or save a copy of the programs for further use to a different User directory (see section 5.4.3).

6.2 System configuration

This option allows setting of the signal tone (beep), Display contrast and time settings.

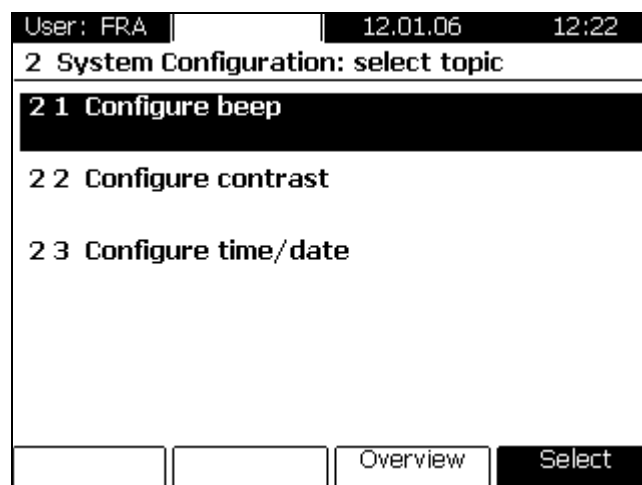

6.2.1 Configure beep

To switch beep on/off toggle between ON and OFF and confirm with Soft Key [Set Beep].

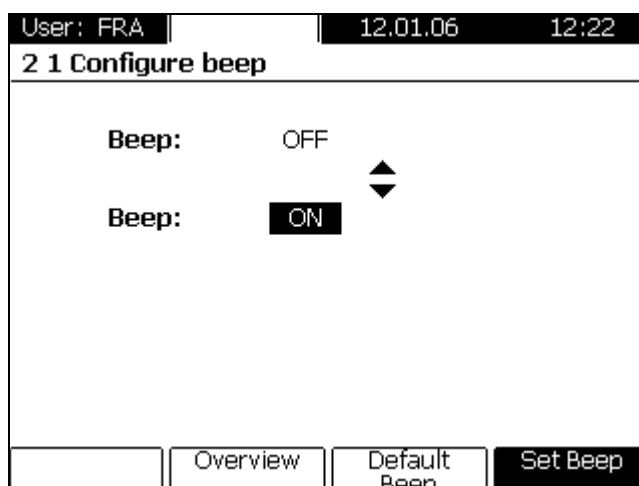

6.2.2 Configure Contrast

The Display contrast can be set individually for each User.

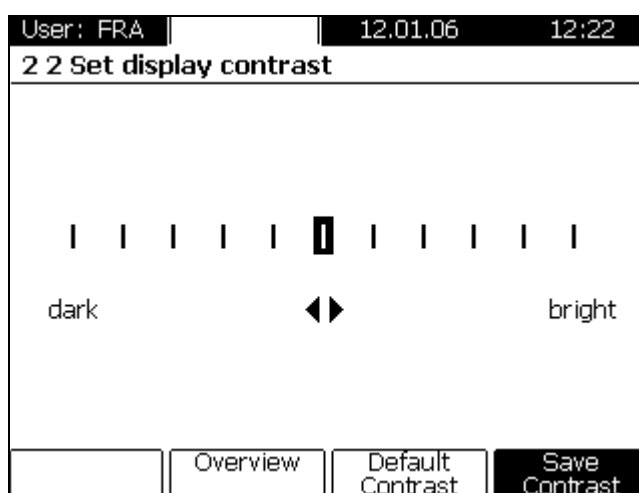

Change settings with Cursor keys and confirm with Soft Key [Save Contrast].

6.2.3 Set time and date

User: FRA		12.01.06	12:22
2 3 Set date and time			
Date			
Day:	16		
Month:	01		
Year:	2006		
Time			
Hours:	15		
Minutes:	10		
		Overview	Set Date and Time

Enter settings for Date and Time and confirm with Soft Key [Set Time and Date].

6.2.4 Defragment memory

By erasing and creating PCR-protocols after a while new files may be stored fragmented in the memory of the TProfessional Basic Thermocycler. This leads to increased memory access times and the software reacts slower to user inputs. By defragmentation the information becomes sorted and is stored in order thus leading to decreased memory access times. Subsequently the software reacts faster to user inputs.

User: FRA		08.07.09	15:06
2 4 Defragment memory			
To defragment memory press			
OK.			
This may take several minutes.			
		Overview	OK

Confirm your selection with [OK] and wait until the defragmentation process is finished.

6.2.5 Screen saver

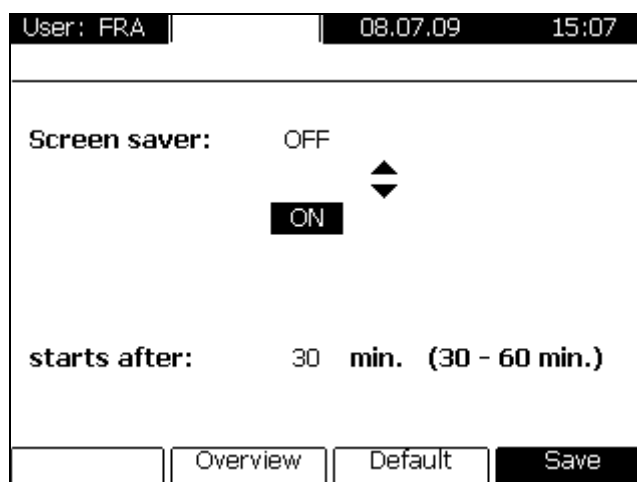

Set the screen saver ON or OFF and if necessary change the time after that the screen saver is started (Standard time is 30 min.) Press [Save] to save the changings.

6.3 System info

This Menu provides information on the instrument and on the Log files of the last five runs.



6.3.1 System info

Use this option to Display the instruments serial number, block type and software version.

User: FRA	12.01.06	12:22
3 1 View system info		
Cyclertype: TProfessional		
Company: Biometra		
Serial No.: Service		
Revisions-No.: 0.0000001		
Blocktype: Gradient 96		
Serial No.: 16741119		
Software-Version: 0.25 - 0.30 - 0.72tpr		
Protocol-Version: 0. 0. 0. 1 - 0. 2. 1. 0 - 0. 2. 1. 0		
		Overview

6.3.2 View Log files of the last five runs

During each run a log file is stored in the Thermocycler memory. The log files of the last five runs can be viewed in this window.

User: FRA	12.01.06	12:22
3 2 Run-logfile: BBE 01 schering 1bc		
Log-Time and Date: 10:55 05.10.05		
Start-Endtime/Date: 08:07 - 09:05 05.08.05 06.08.05		
User: SME Halling	Serial No.: 125	
Cyclertype: TProfessional	Company: Biometra	
Software-Version: 0.38 - 0.29 - 2.5.1		
Block: 1		
Block Serial No.: 3456	Blocktype: Gradient 96	
Messages: Gradient 96		
	View Program	List Run-Logfiles

6.4 Service

User: FRA	12.01.06	12:22
4 Service: select topic		
4 1 Poweron selftest - logfile		
4 2 Execute extended block selftest		
4 3 Extended block selftest - logfiles		
4 4 Error-Logfiles		
4 5 Make Service Info Package		
	Overview	Select

6.4.1 View log files of Power on self test

During boot up (Power on) the TProfessional Basic hardware is checked (Self test). Here you can see the results of the last five self tests.

6.4.2 Execute extended self test

In addition to the regular Power on –Self test, a more comprehensive test can be triggered by the user. In the extended block self test the unit can check the status and condition of different components and functions. Therefore, this test is an important and useful information to the customer whether the Thermocycler is still working within its parameters.

The extended block self test is listed in the [System] Menu under [Service]. With [Execute Selftest] this test is initiated. This test takes several minutes. During the test no programs can be run on the thermocycler.

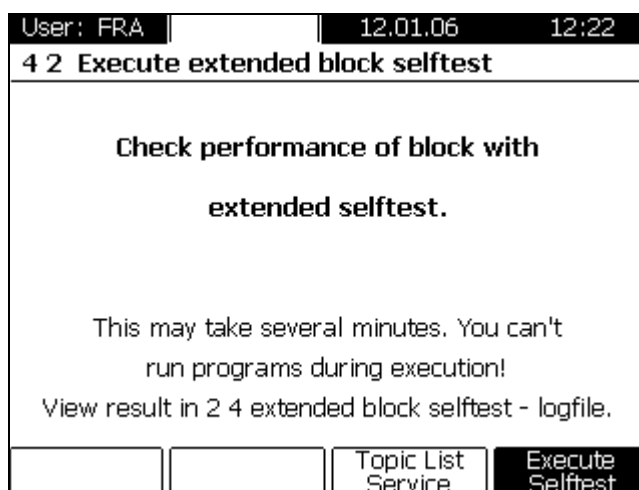

In certain intervals the unit will automatically recommend to check the components of the unit, i.e. to execute a new extended block self test (message 729).

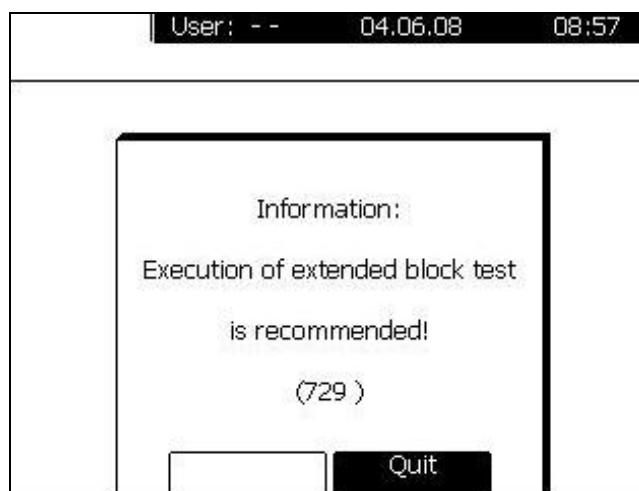

Pressing [Quit] confirms that this recommendation has been noted. In case the unit is switched off but the extended block self test has not been initiated, this recommendation window will appear again if the unit is switched on.

It is recommended to execute an extended self test regularly.

6.4.3 View log files from extended self test

The results of the extended self test logfiles are stored by the instrument. To view a summary of the self test select the suitable logfile from the menu.

User: FRA		08.07.09 15:08	
4 3 Select logfile extended selftest:			
Date	Time	Blocktype	Serialno.
12.09.05	09:09	Gradient 60	12345627
05.10.05	10:55	Gradient 60	12345067
06.10.05	13:05	Gradient 96	25780067
01.01.06	07:30	384 well	25685678
25.04.06	09:55	96 well	36545721
--	--		
		Overview	Select

User: FRA		08.07.09 15:09	
4 3 View logfile of extended block selftest			
Over-all performance block : OK			
Serialno.: 12345627		Blocktype: Gradient 60	
Execution period: 09:09 - 11:25 12.09.05			
Check heating lid: OK			
Check cooling element: OK			
Check thermal tracking: OK			
Check regulation: OK			
Check gradient: OK			
Check heating performance: OK			
Check cooling performance: OK			
		More results	List Logfiles

In the next window the actual status of all important components is summarized at a glance.

6.4.4 View Error log files

A history of all software and hardware errors is shown in this menu.

Note: Sever errors that require action by the User are displayed in the User Software Menu.

6.4.5 Create Info file for Biometra Service Department

This option creates a Service file containing technical details for the Biometra Service Department.

6.5 How to contact Biometra

User: FRA	12.01.06	12:22
5 How to contact Biometra		
Biometra GmbH Rudolf-Wissell-Str. 30 37079 Goettingen Germany		
		+49 (0)551 / 50686 - 0
		+49 (0)551 / 50686 - 66
e-mail: info@biometra.com www.biometra.com		
		OK

6.6 Supervisor system configuration

The supervisor has access to an own system menu with some specific functions.

6.6.1 Change user PIN

The supervisor can change the PIN for each user account. Select the appropriate user directory from the list and enter a new PIN.

6.6.2 Delete user account

Select the user directory to delete from the list and confirm with [OK]. The directory and the programs therein are deleted.

6.6.3 Change supervisor PIN

Enter your actual PIN (the default Supervisor PIN is 000 000 0 (do not enter blanks)), enter your new PIN and repeat your input. Confirm with [PIN OK].

User: SUP	08.07.09	15:10
SUP Change SUP PIN		
Supervisor	SUP	
!!!Attention: Forgotten SUP-PIN can only be changed by Biometra-Service in Germany!!!		
Enter current PIN:	██████████	
Enter new PIN:	_____	
Repeat PIN:	_____	
	Overview	PIN OK

Note: Please make a note of the Supervisor Pin und keep it on a safe spot. A forgotten Supervisor Pin can only be reset by Biometras Service Department and requires to send back the instrument.

6.6.4 Set boot language

The language displayed during the boot process can be set by the supervisor.

6.6.5 Delete all user accounts

The supervisor can delete all user accounts and including all programs. In the next screen confirm with [OK] to delete all accounts.

Note: Deleted user accounts and programs can not be reconstituted

7 Short manual

Safety Warnings



Do not open the instrument unless you are authorised to do so. Check the label at the backside if the instrument has correct voltage configuration (110V, 115 V or 230 V).



The thermoblock and the heated lid will reach high temperatures during operation. Both thermoblock and heated lid can burn you.



Rapid heating of the thermoblock can cause liquids to boil explosively. Always wear safety goggles during operation. Close the lid before starting a program.



It is not necessary to apply oil into the opening of the block in order to improve the heat transfer between the block and the sample tubes. If you still decide to use oil, do not use silicon oil. Mineral oil may be used.

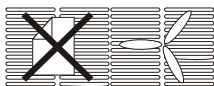

Ensure that both the rear and bottom ventilation slits at the rear and bottom of the instrument are unobstructed. Insufficient ventilation can cause overheating of the instrument.

The TProfessional Basic Control Panel

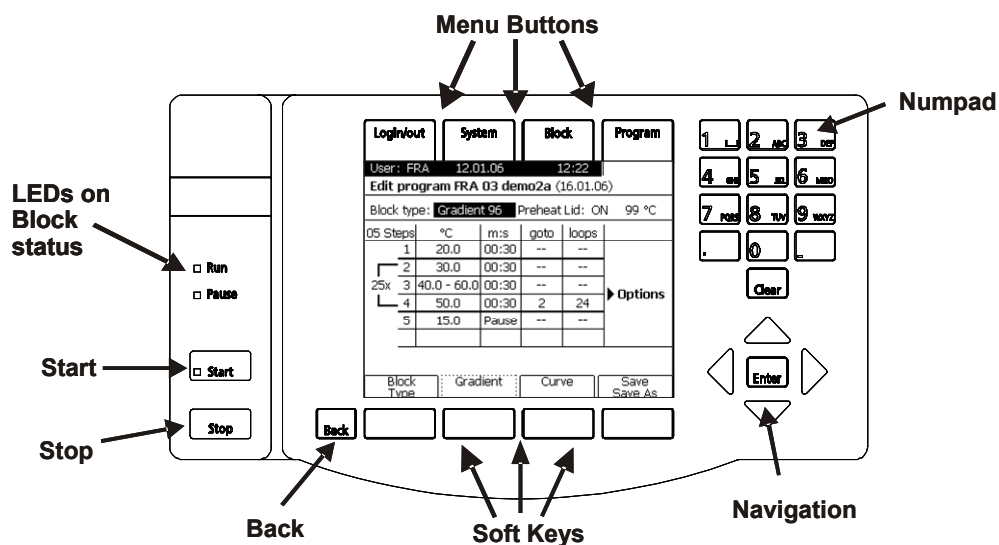

Log in

After the TProfessional Basic has passed the initial self-diagnosis the login menu is displayed:

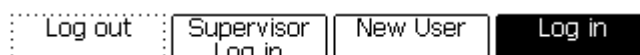

- Press **[Log in]** and log in as existing user
- Press **[Supervisor Log in]** and log in as supervisor
- Press **[New User]** and create new user account

The language displayed in the user interface can be selected (English or German). The selected language will be stored for each individual user.



➔ Press **[Select Language]** to select preferred language

Create, modify and save programs

➔ To create a new or edit an existing program, press the **[Program]** menu button.

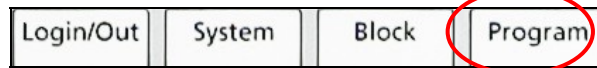

➔ Move cursor to your directory and press **[Open directory]**.



➔ Press **[New Program]** or choose existing program and press **[Edit Program]** to enter the program screen.

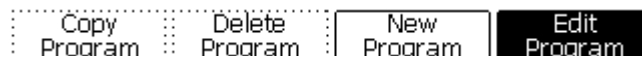

Use the cursor keys to navigate in the program screen. In each case the activated field is displayed inverted. Corresponding to the activated field the assignment of the Soft Keys in the TProfessional Basic control panel will change accordingly.

Note: In the directory “Biometra Shared” you will find pre-installed protocol templates for different PCR applications. In chapter 5.3.1 and 5.8 you will find instructions how to use these protocols.

The TProfessional Basic program screen

Status display „Block type“

Status display „Preheat Lid“

Defined cycles

Options tab

Programming table

06 Steps	°C	m:s	goto	loops
1	95.0	05:00	--	--
2	95.0	02:00	--	--
35x 3	58.0 - 65.0	00:30	--	--
4	72.0	00:50	2	34
5	72.0	05:00	--	--
6	16.0	Pause	--	--

➔ To alter block type activate the corresponding status display and press **[Block Type]**.

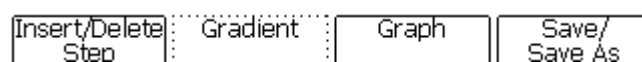

Select appropriate block type from the menu in the next window. (The TProfessional Basic Thermocyclers automatically recognize the installed block module. However, it is also possible to write a program for an alternative block type.)

- To switch lid preheating on or off activate the corresponding status display and press **[Preheat ON/OFF]**.

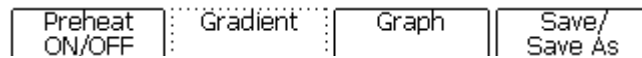

Set lid temperature in status display under [-- °C] within the range of 30°C to 99°C.

- Enter temperature **[°C]** and time **[m:s]** in the programming table for each single step. To hold a temperature for an indefinite time enter "0" under **[m:s]** and press <enter>. Subsequently, the word "pause" is shown in the display.
Note: Minutes and seconds can be separated by "dot". You can also enter the digits one after the other. Example: to set 2 minutes, 30 seconds enter "2", "3", "0" or "2", ".", "3", "0".
- To insert or delete a program step move cursor to the corresponding position in the programming table and press **[Insert/Delete Step]**.

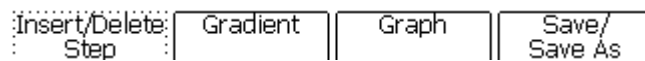

- To insert or delete a program step press **[Insert Step]** or **[Delete Step]**. The position at which a step will be inserted or deleted is highlighted.



- In the next screen confirm insertion or deletion with **[YES]**
- To define a loop A) enter the step the program shall go back to **[goto]** and B) enter how often the loop is repeated **[loops]**. The defined loop is graphically displayed by a bracket at the left side of the spreadsheet, the total cycle number is mentioned.
- To program special features like temperature increment, time increment or heating and cooling rate repeatedly press the cursor key <right> to open the options tab. A new table is displayed:

User: HD		21.02.08		09:30	
Edit program HD 01 test (19.02.08)					
Block type: Gradient 96		Preheat Lid: ON		99 °C	
06 Steps	°C	m:s	ΔT(°C)	Δt (s)	∇(°C/s)
1	95.0	05:00	--	--	5.0
2	95.0	02:00	--	--	5.0
35x 3	58.0 - 65.0	00:30	-0.5	--	5.0
4	72.0	00:50	--	3	5.0
5	72.0	05:00	--	--	5.0
6	16.0	Pause	--	--	5.0

Tip:

Storing samples at 16°C rather than 4°C at the end of a run will increase the instruments life time.

- To reduce or increase the annealing temperature from step to step within a loop set a negative or positive temperature increment under **ΔT(°C)**.
- To increase or reduce the incubation time from step to step in a loop set a positive or negative time increment under **Δt(s)**.
- By default the ramping rate (heating and cooling) is pre-set to 3°C/sec. To adjust the ramping rate, enter any value between 0.1°C and 3.0°C under **∇[°C/s]**.
- (For gradient enabled units only) To define a gradient A) enter the two temperatures of the block (left and right side) separated by a minus under **[°C]** (e.g. 40-60) or B) press **[Gradient]** and then **[Edit linear Gradient]**. This activates the screen for programming linear gradients:

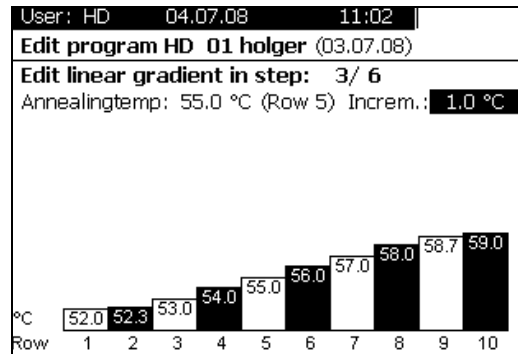

- Enter an annealing temperature. The set annealing temperature defines the temperature in row 6 of the thermoblock. Enter a temperature increment [**Incr.**]. The corresponding temperature profile is shown for each single row.
- Press [**Save/Save as**] to save a program.

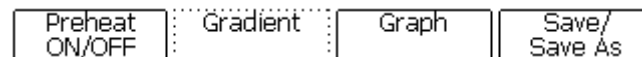

Subsequently the program storage screen opens:

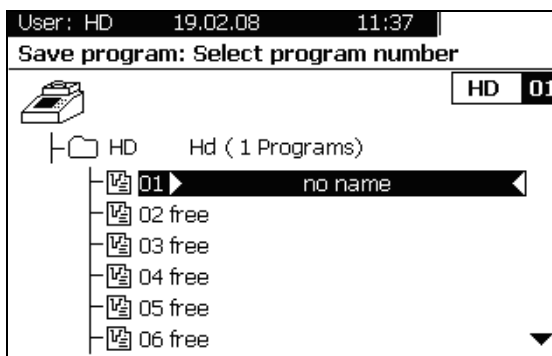

Tip:

A folder with common protocols could be established. From the common folder each user may copy any program into the own account and modify it easily.

- By default the program is stored at the first free storage place available. To save a program at a specific storage place use cursor keys <up> and <down> or enter two digits.
- To edit the name of the program press [**Edit name**]. In the next screen occurring enter a name by using the keypad and confirm with [**OK**].

Start, pause and stop programs

- The TProfessional Basic Thermocycler for each user stores the last 5 programs that have been run or modified. For quick start of one of these programs press the [**Block**] menu button. In the next screen select one of the last five programs by using the cursor keys <up> and <down>. Press the [**Start**] button on the left side of the keypad to start the program.
- To start a program from a user directory log in with your user account and press the [**Program**] menu button. In the next screen select the appropriate user directory and program by navigating with the cursor keys. Press the [**Start**] button on the left side of the keypad to start the selected program. After starting a program the following screen is shown:

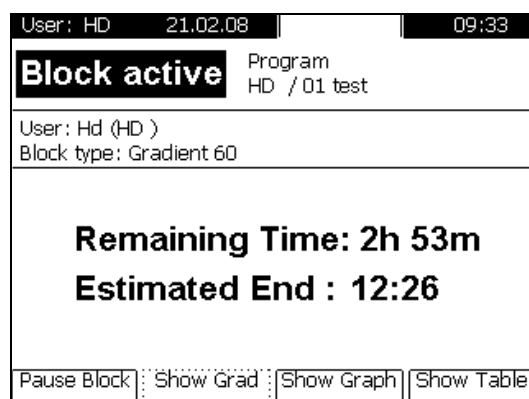

- ➔ To pause an active program press **[Pause Block]**. The message "PAUSE" is shown in the display and alternates with the elapsed time.
- ➔ To continue a paused program press **[Continue]**.

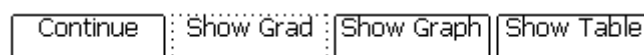

To stop an active program press the **[Stop]** button on the left side of the keypad and confirm with **[OK]** in the TProfessional Basic program screen. Programs with a pause in the last step have to be stopped manually as well.

8 Trouble shooting

8.1 Slow heating and cooling

The TProfessional Basic is equipped with a strong ventilator for the cooling of the heat sink (see also chapter 9.1). The inlet of this fan is located at the bottom side of the instrument. Be sure that the inlet is not clogged by dust or other material (e.g. a sheet of paper placed under the cyclor can be attached to the inlet as the fan is in operation). Dust can be removed easily from the inlet with a conventional vacuum cleaner.

8.2 Autorestart

Running programs will be continued from the same step where the power failure has happened as soon as the power is supplied again. A message is displayed showing (a) that a power failure occurred during the run and (b) when and at which step the program was started again:

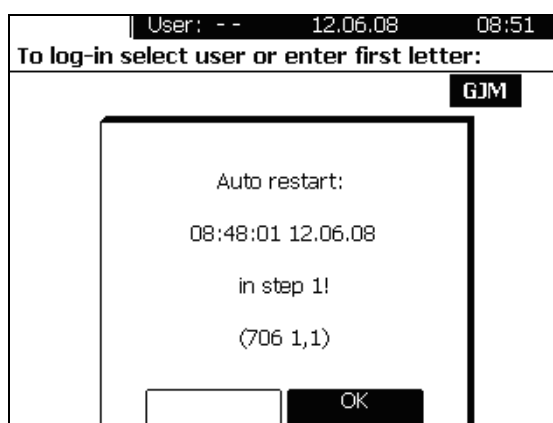

Confirm with [OK] to close the message screen.

8.3 Autorestart due to unrecognised power failure

High voltage fluctuation can lead to an automatic restart of the thermocycler. In this case the cyclor restarts at the step where there power failure has occurred. A message is displayed showing (a) that a power failure occurred during the run and (b) when and at which step the program was started again (see 8.2). To avoid voltage fluctuation, do not connect the cyclor to a socket shared by a strong power consumer like a refrigerator or a centrifuge.

8.4 Adaptation of protocols from other cyclors

Since the TProfessional Basic is a fast instrument it may be necessary to reduce the heating and cooling ramps to run protocols from other cyclors. For the setting of the heating and cooling ramps see section 5.5.1. Alternatively, the time settings may be extended.

8.5 Releasing wheel in case of blocked lid

When the lid is in the very up or down position, it may happen that the wheel is uncoupled. In this situation the clutch mechanism is active in both directions (clicking noise in either direction).

To unlock wheel, press down metal pin with a ball pen and turn wheel carefully. This pin overrides the automatic clutch mechanism. Thus, care must be taken not to apply excessive pressure.

Release lid in upper position:

- 1) press pin
- 2) carefully turn wheel while holding the pin down **CLOCKWISE**, until you feel normal resistance (no more clicking noise, clutch is released). Release pin and turn lid down, until the clutch mechanism is activated (clicking noise, optimum pressure applied).

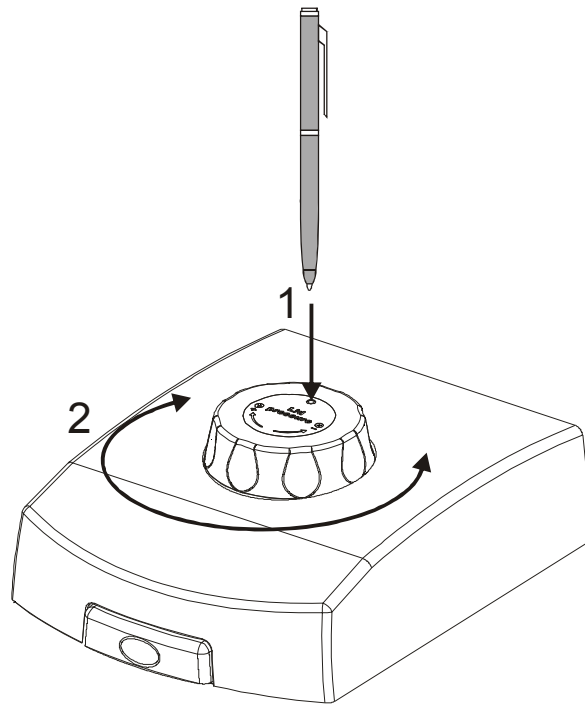

Release lid in down position:

- 1) press pin
- 2) carefully turn wheel while holding the pin down **COUNTER CLOCKWISE**, until you feel normal resistance (no more clicking noise, clutch is released). Release pin and turn wheel counter clockwise until pressure is completely released. Open lid.

Important: When the clutch mechanism is active (= optimum pressure is applied), do not use pin to further increase lid pressure. This would lead to damage of tubes and instrument!

9 Maintenance and repair

9.1 Cleaning and Maintenance

The TProfessional Basic was built to operate for a long time without the need for periodical maintenance. Nevertheless, occasionally cleaning of the air inlet may be necessary to maintain the efficiency of the Thermocycler. Insufficient airflow may lead to reduced heating and cooling rates (see chapter 8.1). The inlet for the airflow is located at the bottom side of the instrument. Be sure that the inlet is not clogged by dust or other material (e.g. a sheet of paper placed under the cyclor can be attached to the inlet as the fan is in operation). Dust can be removed easily from the inlet with a conventional vacuum cleaner. Additionally, the Thermocycler housing may be cleaned from time to time with a smooth cotton cloth. Do not use strong detergents or organic solvents for cleaning. Never treat silver block with abrasive agents.

Important: Appropriate safety regulations must be observed when working with infectious or pathogenic material.

9.2 Servicing and repair

The TProfessional Basic Thermocycler contains no user serviceable parts. Do not open the housing instrument. Service and repair may only be carried out by the Biometra Service department or otherwise qualified technical personal.

The Service department offers Thermocycler maintenances and temperature verifications. Biometra recommends an annual maintenance and a biannual temperature check for all Thermocyclers. Please call the following phone number for detailed information: +49 551-50881-10/12.

9.3 Firmware update

For instruction for firmware upgrade, please contact the Biometra Service Department or your local distributor/sales representative.

9.4 Replacement of Spare Parts

Only original spare parts mentioned in these operating instructions are allowed.

10 Accessories

10.1 Plasticware

Biometra offers a broad range of plasticware for the use in PCR. The following table provides an overview for the product portfolio:

Cat. no.	Description	Quantity
Single tubes		
050-310	0.2 ml tubes with caps	1000 pcs.
050-320	0.5 ml tubes with caps	1000 pcs.
Tube strips		
050-254	Strips 8 tubes and flat caps	125 pcs.
050-255	Strips 8 tubes and domed caps	125 pcs.
48 well plates		
050-225	48 well microplate	50 pcs.
96 well plates		
050-232	96 well skirted	25 pcs.
050-213	96 well non-skirted (low profile)	25 pcs.
050-253	96 well non-skirted	25 pcs.
384 well plates		
050-231	HSQ 384 well skirted	50 pcs.
050-240	384 well microplate	50 pcs.
Miscellaneous		
050-237	Silicone mat	50 pcs.
050-256	Adhesive film	100 pcs.
050-257	Heat Sealing Film	100 pcs.
050-236	Heat Sealing Film Aluminium	10 pcs.
050-194	96 well aluminium plate	1 pcs.
050-694	384 well aluminium plate	1 pcs.
050-251	Nop mat 96 well	20 pcs.
050-252	Nop mat 384 well	20 pcs.

11 Service

Should you have any problems with this unit, please contact our service department or your local Biometra dealer:

Biometra GmbH

Service Department

Rudolf-Wissell-Straße 14 - 16

D-37079 Göttingen

Phone: ++49 (0)5 51 50 68 6 - 10 or 12

Fax: ++49 (0)5 51 50 68 6 -11

e-mail: Service@biometra.com



If you would like to send the unit back to us, please read the following return instructions in chapter 11.1.

11.1 Instructions for return shipment

In case of an instrument failure that cannot be fixed by the procedures described in section 8 please proceed as follows:

- Return only defective devices. For technical problems which are not definitively recognisable as device faults please contact the Technical Service Department at Biometra (Tel.: +49 551-50881-10/12, Fax: +49 551-50881-11, e-mail: service@biometra.com).
- Please contact our service department for providing a **return authorization number (RAN)**. This number has to be applied clearly visible to the outer box. **Returns without the RAN will be not be accepted!**
- **Important:** Carefully clean all parts of the instrument of biologically dangerous, chemical or radioactive contaminants. If an instrument is contaminated, Biometra will be forced to refuse to accept the device. The sender of the repair order will be held liable for possible losses resulting from insufficient decontamination of the device.
- Please prepare written confirmation that the device is free from biologically dangerous and radioactive contaminants. The declaration of decontamination (see section 12) must be attached to the outside of the packaging.
- Use the original packing material. If not available, contact Biometra or your local distributor.
- Label the outside of the box with "CAUTION! SENSITIVE ELECTRONIC INSTRUMENT!"
- Please enclose a note which contains the following:
 - a) Sender's name and address,
 - b) Name of a contact person for further inquiries with telephone number,
 - c) Description of the fault, which also reveals during which procedures the fault occurred, if possible

11.2 Packing of the Thermocycler

Biometra uses an extra designed packaging system where the instrument is mounted in between two tearproof foils. The Thermocycler is put onto the lower inlet and is fixed in between the foils by pressing the upper inlet down.

Note: The Thermocycler is only protected from transport damage if the packing instructions are followed and the instrument is mounted in between the foils. Biometra will not be responsible for transport damage by improper packing.

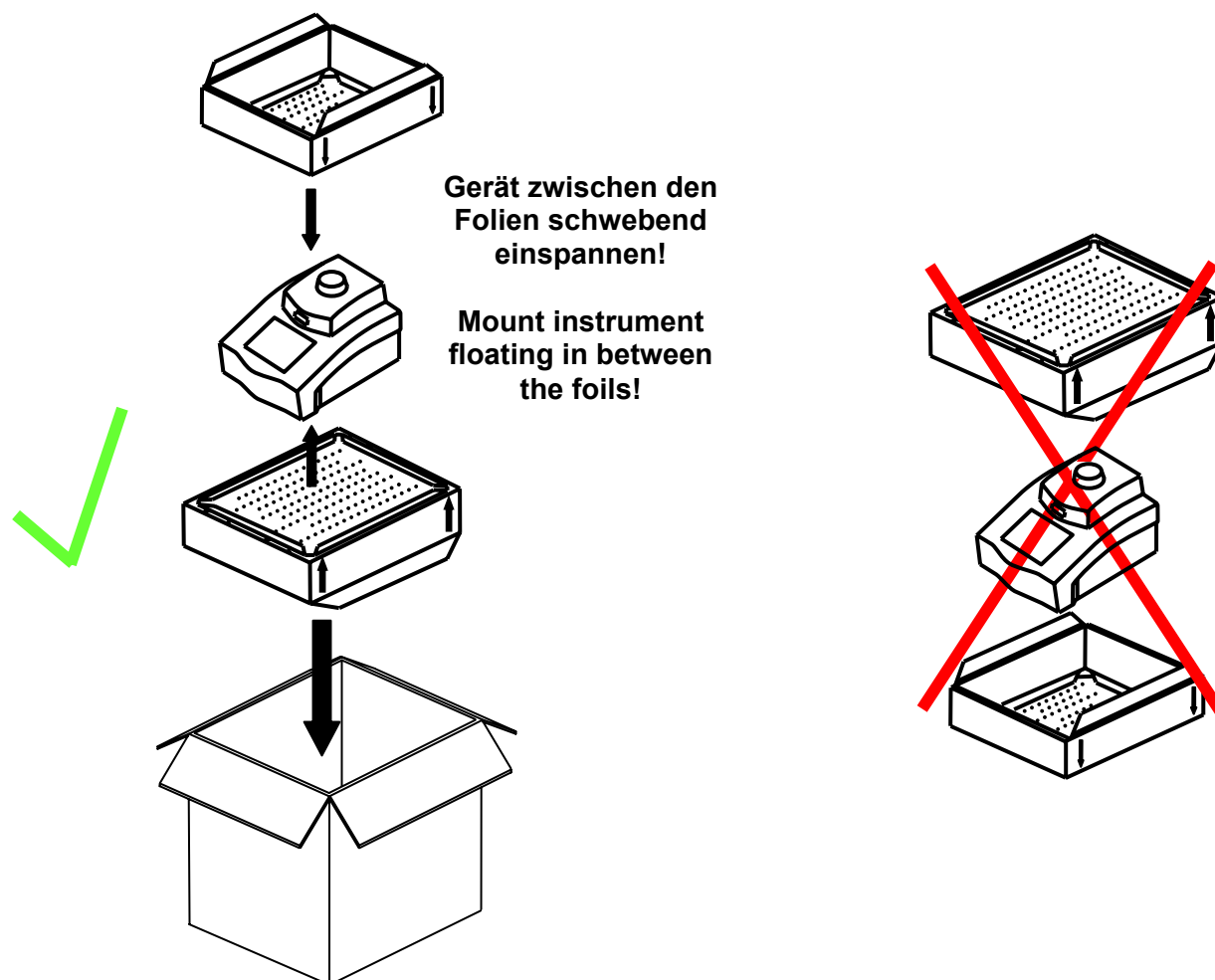

12 Equipment Decontamination Certificate

To enable us to comply with german law (i.e. §71 StrlSchV, §17 GefStoffV and §19 ChemG) and to avoid exposure to hazardous materials during handling or repair, please complete this form, prior to the equipment leaving your laboratory.

COMPANY / INSTITUTE _____

ADDRESS _____

PHONE NO _____ FAX NO _____

E-MAIL _____

EQUIPMENT	Model	Serial No
	_____	_____
	_____	_____
	_____	_____
	_____	_____

If on loan / evaluation Start Date: _____ Finish Date _____

Hazardous materials used with this equipment:

Method of cleaning / decontamination:

The equipment has been cleaned and decontaminated:

NAME _____ POSITION _____
(HEAD OF DIV./ DEP./ INSTITUTE / COMPANY)

SIGNED _____ DATE _____

PLEASE RETURN THIS FORM TO BIOMETRA GMBH OR YOUR LOCAL BIOMETRA DISTRIBUTOR TOGETHER WITH THE EQUIPMENT.

PLEASE ATTACH THIS CERTIFICATE OUTSIDE THE PACKAGING. INSTRUMENTS WITHOUT THIS CERTIFICATE ATTACHED WILL BE RETURNED TO SENDER.

General Information for Decontamination:

Please contact your responsible health & safety officer for details.

Use of radioactive substances:

Please contact your responsible person for details.

Use of genetically change organism or parts of those:

Please contact your responsible person for details.

13 Note for the disposal of electric / electronic waste.

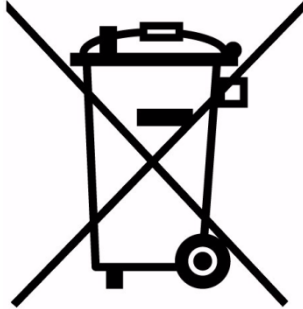
	Note	for disposal of electric / electronic waste	
	Hinweis	für die Entsorgung von Elektroaltgeräten	
	Renseignement	du <u>traitement des déchets</u> des appareils électrique / électronique	

This symbol (the crossed-out wheeled bin) means, that this product should be brought to the return and / or separate systems available to end-users according to your country regulations, when this product has reached the end of its lifetime.

For details, please contact your local distributor!

This symbol applies only to the countries within the EEA*.

EEA = European Economic Area, comprising all EU-members plus Norway, Iceland and Liechtenstein.

Dieses Symbol (die durchgestrichene Abfalltonne) bedeutet, dass dieses Produkt von der Firma Biometra für eine kostenlose Entsorgung zurückgenommen wird. Dies gilt nur für Geräte, die innerhalb Deutschlands gekauft worden sind.

Kontaktieren Sie für die Entsorgung bitte die Biometra Service-Abteilung!
Außerhalb Deutschlands wenden Sie sich bitte an den lokalen Händler.

Dieses Symbol gilt nur in Staaten des EWR*.

*EWR = Europäischer Wirtschaftsraum, umfasst die EU-Mitgliedsstaaten sowie Norwegen, Island und Liechtenstein.

Cet symbol (conteneur à déchets barré d'une croix) signifie que le produit, en fin de vie, doit être retourné à un des systèmes de collecte mis à la disposition des utilisateurs finaux en conséquence des réglementations par la loi de votre pays.

Pour des information additionnel nous Vous demandons de contacter votre distributeur!

Cet symbole s'applique uniquement aux pays de l'EEE*.

EEE = Espace économique européen, qui regroupe les États membres de l'UE et la Norvège, Islande et le Liechtenstein.

14 Declaration of Conformity

EU – Konformitätserklärung
EC - Declaration of Conformity

Göttingen, April 2011

im Sinne der EG-Richtlinie über elektrische Betriebsmittel zur Verwendung innerhalb bestimmter Spannungsgrenzen 2006/95/EG
following the EC directive about electrical equipment for use within certain limits of voltage 2006/95/EC

und / and

im Sinne der EG-Richtlinie für die elektromagnetische Verträglichkeit 2004/108/EG.
following the EC directive about the electromagnetic compatibility 2004/108/EC.

Hiermit erklären wir, dass folgende **Thermocycler**:
*Herewith we declare that the following **Thermocyclers**:*

Typen / types: TProfessional Basic, TProfessional Basic Gradient,
TProfessional Basic XL, TProfessional Basic XL Gradient
Best.-Nr. / Order No.: 070-701, 070-702, 070-601, 070-602

den grundlegenden Anforderungen der
corresponds to the basic requirements of

EG-Niederspannungsrichtlinie 2006/95/EG und der
EC low voltage directive 2006/95/EC and the

EG-Richtlinie über die elektromagnetische Verträglichkeit 2004/108/EG entsprechen.
EC directive about the electromagnetic compatibility 2004/108/EC.

Folgende harmonisierte Normen wurden angewandt:
The following harmonized standards have been used:

EN61326

EN61000-3-2

EN61000-3-3

EN61010-1

EN61010-2-010

Dr. Jürgen Otte
Quality Manager

15 Warranty

This Biometra instrument has been carefully build, inspected and quality controlled before dispatch. Hereby Biometra warrants that this instrument conforms to the specifications given in this manual. This warranty covers defects in materials or workmanship as described under the following conditions:

This warranty is valid for 24 month from date of shipment to the customer from Biometra. This warranty will not be extended to a third party without a written agreement of Biometra.

This warranty covers only the instrument and all original accessories delivered with the instrument. This warranty is valid only if the instrument is operated as described in the manual.

Biometra will repair or replace each part which is returned and found to be defective. This warranty does not apply to wear from normal use, failure to follow operating instructions, negligence or to parts altered or abused.

16 Subject Index

Autorestart.....	62	linear Gradient.....	32
Beep.....	48	loop.....	27
Block Menu.....	18	pause.....	28, 44
Contact.....	55	quick start.....	42
Contrast.....	49	save.....	28
Control panel.....	15	spread sheet mode.....	38
Declaration of Conformity.....	71	start.....	41
Decontamination Certificate.....	68	stop.....	45
Defragmentation.....	50	temperature increment.....	41
Disposal.....	70	time increment.....	40
Fast-PCR.....	45	Program Menu.....	19
Firmware update.....	64	Repair.....	64
Gradient.....	31	Safety precautions.....	8
linear Gradient.....	32	Screen saver.....	50
Heated lid.....	15, 25, 26	Self test	
Heated Lid.....	62	extended.....	53
Language.....	47, 56	Power on self test.....	53
Log file.....	53, 54	Service.....	52
Log in.....	20	Service info file.....	54
Log in Menu.....	18	Servicing.....	64
Maintenance.....	64	Short manual.....	57
Operation Voltage.....	12	Start.....	41
Packing.....	67	Stop.....	45
PIN-Code.....	21, 47, 55	Supervisor.....	23, 55
Plasticware.....	65	System configuration.....	48
Program		System info.....	51
continue.....	45	System menu.....	19
cooling rate.....	40	System settings.....	47
copy.....	36	Technical specifications.....	6
create.....	23	Time and Date.....	50
delete.....	37	User account	
delete step.....	35	create.....	22
edit.....	33	delete.....	23, 55, 56
Gradient.....	31	User Account	
graphical mode.....	38	Delete.....	48
heating rate.....	40	User interface.....	17
insert step.....	33	Warranty.....	72