

Watson-Marlow 520UN IP66/NEMA 4X pumps



Contents

1	Declaration of conformity	3	16.12 Security code	44
2	Declaration of incorporation	3	16.13 Exit	45
3	Five-year warranty	4	17 MemoDose	46
4	When you unpack your pump	5	17.1 Changing dosing speed	47
5	Information for returning pumps	6	17.2 Footswitch operation with MemoDose	48
6	Peristaltic pumps: an overview	7	18 Flow calibration	49
7	Safety notes	8	18.1 Exit	51
8	Pump specifications	10	19 Pin-out details	51
8.1	Dimensions	15	21 Exit	51
9	Good pump installation practice	16	21 Automatic control wiring	52
9.1	General recommendations	16	21.1 520N module fitting	52
9.2	Do's and do not's	17	21.2 Wiring up	54
10	Connecting this product to a power supply	18	21.3 Speed: analogue input	57
11	Start-up check list	21	21.4 Speed: analogue output	58
12	Switching the pump on for the first time	21	21.5 Tachometer frequency output	58
13	Switching the pump on in subsequent power cycles (if not in auto-restart mode)	23	21.6 Run / stop input	59
14	Manual operation	24	21.7 Direction input	59
14.1	Keypad functions in manual mode	24	21.8 Auto / manual toggle	60
14.2	Keypad lock	27	21.9 MemoDose input	60
14.3	Keypad beep	27	21.10 Leak detection input	60
14.4	Manual operation and remote digital inputs and outputs	27	21.11 Outputs 1, 2, 3, 4	61
15	Main menu	28	21.12 Supply voltages	62
15.1	Keypad functions in menu screens	28	22 Automatic control and operation	63
15.2	Main menu entry	29	23 Troubleshooting	65
16	Setup	30	23.1 Error codes	66
16.1	Trim	32	24 Drive maintenance	67
16.2	Analogue	33	25 Drive spares	67
16.3	Display	35	26 The 520R, 520R2 and 520RE pumpheads	68
16.4	Outputs	36	26.1 Pumphead fitting	69
16.5	Remote stop	38	27 520R, 520R2 and 520RE installation	71
16.6	Auto-restart	40	27.1 Opening the guard	71
16.7	Set maximum speed	41	27.2 520R and 520R2 tube loading	72
16.8	Backlight	41	27.3 520RE: fitting the drain port	73
16.9	ROM	42	27.4 520RE Element loading	74
16.10	Language	42	27.5 520RE Element connection	76
16.11	Defaults	43		

28	520R, 520R2 and 520RE maintenance	77
29	520R, 520R2 and 520RE rotor settings	78
30	Pumphead spares	79
31	Flow rates	80
32	Tubing and element part numbers	88
33	520 series pumping accessories	91
34	Trademarks	92
35	Patient-connected applications	92
36	Publication history	92
37	Decontamination certificate	93

1 Declaration of conformity



This declaration was issued for Watson-Marlow 520UN pumps on February 1, 2004. When this pump unit is used as a stand-alone pump it complies with: Machinery Directive 2006/42/EC, EMC Directive 2004/108/EC.



This pump is ETL listed: ETL control number 3050250. Cert to CAN/CSA std C22.2 No 1010-92. Conforms to UL std 61010A, April 30, 2002.

See 8 *Pump specifications*.

2 Declaration of incorporation

When this pump unit is to be installed into a machine or is to be assembled with other machines for installations, it must not be put into service until the relevant machinery has been declared in conformity with the Machinery Directive 2006/42/EC. See 8 *Pump specifications*.

Responsible person: Christopher Gadsden, Managing Director, Watson-Marlow Limited, Falmouth, Cornwall TR11 4RU, England. Telephone +44 (0) 1326 370370 Fax +44 (0) 1326 376009.

A handwritten signature in black ink, appearing to read 'C. Gadsden'.

The information in this user guide is believed to be correct at the time of publication. However, Watson-Marlow Limited accepts no liability for errors or omissions. Watson-Marlow Bredel has a policy of continuous product improvement, and reserves the right to alter specifications without notice. This manual is intended for use only with the pump it was issued with. Earlier or later models may differ. The most up-to-date manuals appear on the Watson-Marlow website: <http://www.watson-marlow.com>

3 Five year warranty

520 cased pumps, 620 cased pumps and 720 cased pumps

For any 520, 620 or 720 cased pump purchased after 1 January 2007, Watson-Marlow Limited ("Watson-Marlow") warrants, subject to the conditions and exceptions below, through either Watson-Marlow, its subsidiaries, or its authorised distributors, to repair or replace free of charge, any part of the product which fails within five years of the day of manufacture of the product. Such failure must have occurred because of defect in material or workmanship and not as a result of operation of the product other than in normal operation as defined in this pump manual.

Watson-Marlow shall not be liable for any loss, damage, or expense directly or indirectly related to or arising out of the use of its products, including damage or injury caused to other products, machinery, buildings, or property, and Watson-Marlow shall not be liable for consequential damages, including, without limitation, lost profits, loss of time, inconvenience, loss of product being pumped, and loss of production. This warranty does not obligate Watson-Marlow to bear any costs of removal, installation, transportation, or other charges which may arise in connection with a warranty claim.

Conditions of and specific exceptions to the above warranty are:

Conditions

- Products must be returned by pre-arrangement, carriage-paid, to Watson-Marlow, or a Watson-Marlow approved service centre.
- All repairs or modifications must have been made by Watson-Marlow Limited, or a Watson-Marlow approved service centre or with the express permission of Watson-Marlow.
- Warranties purporting to be on behalf of Watson-Marlow made by any person, including representatives of Watson-Marlow, its subsidiaries, or its distributors, which do not accord with the terms of this warranty shall not be binding upon Watson-Marlow unless expressly approved in writing by a Director or Manager of Watson-Marlow.

Exceptions

- The warranty shall not apply to repairs or service necessitated by normal wear and tear or for lack of reasonable and proper maintenance.
- All tubing and pumping elements as consumable items are excluded.
- Products which, in the judgment of Watson-Marlow, have been abused, misused, or subjected to malicious or accidental damage or neglect are excluded.
- Electrical surge as a cause of failure is excluded.
- Chemical attack is excluded
- All pumphead rollers are excluded.
- The 620R family of pumpheads are excluded from all warranty when pumping above 2 bar while above 165rpm.
- Pumpheads from the 313/314 and the Microcassette ranges and any 701 extension pumpheads are excluded and retain their one-year standard pumphead warranty. The drive they are attached to is subject to the five-year warranty as set out here.
- Ancillaries such as leak detectors are excluded.

4 When you unpack your pump

Unpack all parts carefully, retaining the packaging until you are sure all components are present and in good order. Check against the components supplied lists, below.

Packaging disposal

Dispose of packaging materials safely, and in accordance with regulations in your area. Pay particular attention to the expanded polystyrene shockproof shells. The outer carton is made of corrugated cardboard and can be recycled.

Inspection

Check that all components are present. Inspect components for damage in transit. If anything is missing or damaged, contact your distributor immediately.

Components supplied (520UN pump, IP66/NEMA 4X)



- The 520U pump drive unit fitted with:
 - 520R2 or other pumphead (see 8 *Pump specifications*) if specified as a pump
 - A 520N watertight module providing pump ingress protection to IP66, NEMA 4X.
Note: the module is attached for transit, but must be removed to allow wiring up, voltage selection and fuse inspection and then re-affixed before the pump is operated.
 - The designated mains power lead for your pump
- PC-readable CDROM containing these operating instructions
- Quick Start manual

Note: Some versions of this product will include components different from those listed above. Check against your purchase order.

Storage

This product has an extended shelf life. However, care should be taken after storage to ensure that all parts function correctly. Users should be aware that the pump contains a battery with an unused life of seven years. Long-term storage is not recommended for peristaltic pump tubing. Please observe the storage recommendations and use-by dates which apply to tubing you may wish to bring into service after storage.

5 Information for returning pumps

Equipment which has been contaminated with, or exposed to, body fluids, toxic chemicals or any other substance hazardous to health must be decontaminated before it is returned to Watson-Marlow or its distributor.

A certificate included at the rear of these operating instructions, or signed statement, must be attached to the outside of the shipping carton. This certificate is required even if the pump is unused. See 37 *Decontamination certificate*.

If the pump has been used, the fluids that have been in contact with the pump and the cleaning procedure must be specified along with a statement that the equipment has been decontaminated.

6 Peristaltic pumps - an overview

Peristaltic pumps are the simplest possible pump, with no valves, seals or glands to clog or corrode. The fluid contacts only the bore of a tube, eliminating the risk of the pump contaminating the fluid, or the fluid contaminating the pump. Peristaltic pumps can operate dry without risk.

How they work

A compressible tube is squeezed between a roller and a track on an arc of a circle, creating a seal at the point of contact. As the roller advances along the tube, the seal also advances. After the roller has passed, the tube returns to its original shape, creating a partial vacuum which is filled by fluid drawn from the inlet port.

Before the roller reaches the end of the track, a second roller compresses the tube at the start of the track, isolating a packet of fluid between the compression points. As the first roller leaves the track, the second continues to advance, expelling the packet of fluid through the pump's discharge port. At the same time, a new partial vacuum is created behind the second roller into which more fluid is drawn from the inlet port.

Backflow and siphoning do not occur, and the pump effectively seals the tube when it is inactive. No valves are needed.

The principle may be demonstrated by squeezing a soft tube between thumb and finger and sliding it along: fluid is expelled from one end of the tube while more is drawn in at the other.

Animal digestive tracts function in a similar way.

Suitable applications

Peristaltic pumping is ideal for most fluids, including viscous, shear-sensitive, corrosive and abrasive fluids, and those containing suspended solids. They are especially useful for pumping operations where hygiene is important.

Peristaltic pumps operate on the positive displacement principle. They are particularly suitable for metering, dosing and dispensing applications. Pumps are easy to install, simple to operate and inexpensive to maintain.

7 Safety notes

In the interests of safety, this pump and the tubing selected should only be used by competent, suitably trained personnel after they have read and understood this manual, and considered any hazard involved. If the pump is used in a manner not specified by Watson-Marlow Ltd, the protection provided by the pump may be impaired.

Any person who is involved in the installation or maintenance of this equipment should be fully competent to carry out the work. In the UK this person should also be familiar with the Health and Safety at Work Act 1974.



This symbol, used on the pump and in this manual, means: Caution, refer to accompanying documents.



This symbol, used on the pump and in this manual, means: Do not allow fingers to contact moving parts.



This symbol, used on the pump and in this manual, means: Recycle this product under the terms of the EU Waste Electrical and Electronic Equipment (WEEE) Directive.



Fundamental work with regard to lifting, transportation, installation, starting-up, maintenance and repair should be performed by qualified personnel only. The unit must be isolated from mains power while work is being carried out. The motor must be secured against accidental start-up.



There is a user-replaceable type T2,5A H 250V fuse in the fuseholder in the centre of the switchplate at the back of the pump. *The 520N module must be removed to allow access to the switchplate. See 21.1 520N module removal and replacement.* There is a fuse on the interface card which self-resets after five seconds. There are no user-serviceable fuses or parts inside this pump.

There are moving parts inside the pumphead. Before opening the tool-unlockable pumphead guard, ensure that the following safety directions are followed.

- Ensure that the pump is isolated from the mains power.
- Ensure that there is no pressure in the pipeline.
- If a tube failure has occurred, ensure that any fluid in the pumphead has been allowed to drain to a suitable vessel, container or drain.
- Ensure that protective clothing and eye protection are worn if hazardous fluids are pumped.
- Primary operator protection from rotating parts of the pump is provided by the pumphead safeguard. Note that safeguards differ, depending on the type of pumphead. See the pumphead section of this manual.

This pump must be used only for its intended purpose.

The pump must be accessible at all times to facilitate operation and maintenance. Access points must not be obstructed or blocked. Do not fit any devices to the drive unit other than those tested and approved by Watson-Marlow. Doing so could lead to injury to persons or damage to property for which no liability can be accepted.

If hazardous fluids are to be pumped, safety procedures specific to the particular fluid and application must be put in place to protect against injury to persons.

The exterior surfaces of the pump may get hot during operation. Do not take hold of the pump while it is running. Let it cool after use before handling it. The drive unit must not be run without a pumphead fitted.



This product does not comply with the ATEX directive and must not be used in explosive atmospheres.

8 Pump specifications

Labels fixed to the rear of the pump contain manufacturer and contact details, product reference number, serial number and model details.

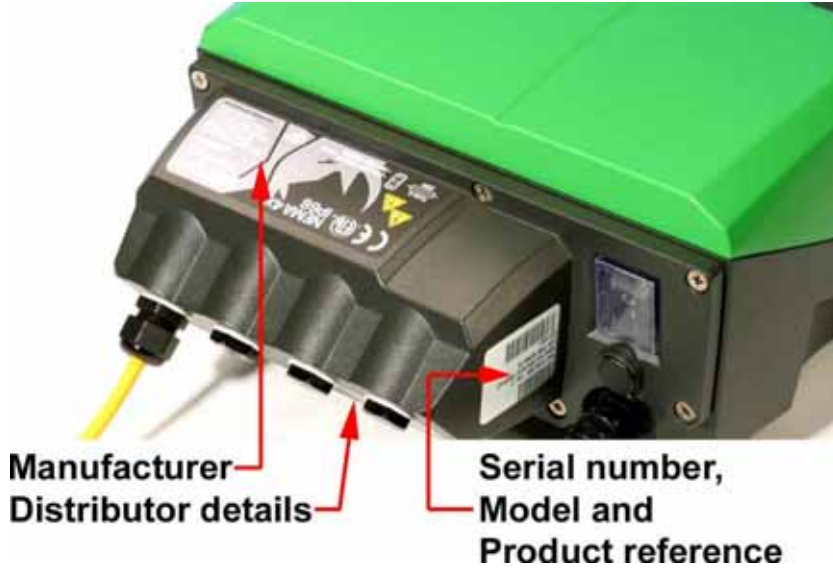

The same information is carried on the drive's backplate, accessible when the 520N module is removed.

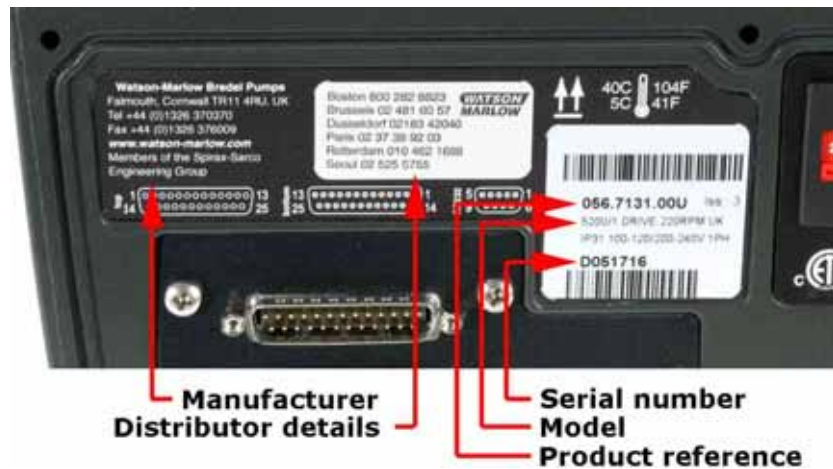

520UN, IP66/NEMA 4X model

This pump can be controlled from the keypad or remotely. It features:

Manual control

Speed adjustment; run and stop; direction control; "max" key for rapid priming.

Remote control

The pump can be digitally controlled with a contact closure or logic input signal to operate the pump.

Analogue control

The pump speed can be controlled through an analogue signal input in the ranges 0-10V or 4-20mA.

Outputs

A 0-10V or 0-1258Hz output signal provides feedback of the pump speed. There are four 24V relay status outputs which can be configured in software for a variety of pump parameters.

MemoDose

Allows precise repeat dosing. Stores in memory a pulse count from the motor. This count is repeated each time **START** is pressed to provide a single-shot dose.

Calibration dose

Uses the same pulse count as MemoDose. The corresponding pumped volume can be entered to calibrate the flow of the pump.

IP (Ingress Protection) and NEMA definitions

IP		NEMA
1st Digit	2nd Digit	
3 Protected against ingress of solid objects with a diameter of more than 2.5mm. Tools, wires etc with a thickness of more than 2.5mm are prevented from approach	1 Protection against dripping water falling vertically. No harmful effect must be produced	2 Indoor use to provide a degree of protection against limited amounts of falling water and dirt
5 Protected against harmful dust deposits. Ingress of dust is not totally prevented but the dust must not enter in sufficient quantity to interfere with satisfactory operation of the equipment. Complete protection against contact	5 Protection against water projected from a nozzle against the equipment (enclosure) from any direction. There must be no harmful effect (water jet)	12 Indoor use to provide a degree of protection against dust, falling dirt and dripping, non-corrosive liquids
		13 Indoor use to provide a degree of protection against dust and spraying water, oil and non-corrosive coolants
6 Protection against ingress of dust (dust-tight). Complete protection against contact	6 Protection against heavy seas or powerful water jets. Water must not enter the equipment (enclosure) in harmful quantities (splashing over)	4X Indoor or outdoor* use to provide a degree of protection against splashing water, wind-blown dust and rain, hose-directed water; undamaged by the formation of ice on the enclosure. (Resist corrosion: 200-hour salt spray)

* 520N cased pumps are rated to NEMA 4X (indoor use) only.

Pump specifications

Control range (turndown ratio)	0.1-220rpm (2200:1)
Supply voltage/frequency	100-120V/200-240V 50/60Hz 1ph
Maximum voltage fluctuation	±10% of nominal voltage. A well regulated electrical mains supply is required along with cable connections to the best practice of noise immunity
Installation category (overvoltage category)	II
Power consumption	135VA
Full load current	<0.6A at 230V; <1.25A at 115V
Eprom version	Accessible through pump software
Enclosure rating	IP66 to BS EN 60529; NEMA 4X to NEMA 250 *
Pumphead options	520R, 501RL, 313, 314, 505L, 505BA, 505CA, 314MC, 318MC
Operating temperature range	5C to 40C, 41F to 104F
Storage temperature range	-40C to 70C, -40F to 158F
Maximum altitude	2,000m, 6,560ft
Humidity (non-condensing)	80% up to 31C, 88F, decreasing linearly to 50% at 40C, 104F
Pollution degree	2
Noise	<70dB(A) at 1m

Note: 520 drive models are C ETL US listed. Cert to std CAN/CSA C22.2 No 1010-92. Conforms to std UL 61010A-1 April 30, 2002.

Note: 520 drive models have been tested in accordance with BS EN 61000-6-2:2001 (EN 61000-4-4) Fast Transient and Burst Tests to Industrial limits - ie: Level 3 : 2kV.

* Protect from prolonged UV exposure.

Standards

EC harmonised standards	Safety of machinery - electrical equipment of machines: BS EN 60204-1
	Safety requirements for electrical equipment for measurement, control and laboratory use: BS EN 61010-1 incorporating A2 Category 2, Pollution degree 2
	Degrees of protection provided by enclosures (IP code): BS EN 60529 amendments 1 and 2
	Conducted emissions: BS EN 55011 A1 and A2 Class A, called by BS EN61000-6-4
	Radiated emissions: BS EN 55011 A1 and A2 Class A, called by BS EN61000-6-4
	Electrostatic discharge: BS EN 61000-4-2
	Radiated RF immunity: BS EN 61000-4-3 A1 and A2, called by BS EN61000-6-2
	Fast transient burst: BS EN 61000-4-4 A1 and A2, level 3 (2kV), called by BS EN61000-6-2
	Surge immunity: BS EN 61000-4-5 A1 and A2, called by BS EN61000-6-2
	Conducted RF immunity: BS EN 61000-4-6, called by BS EN61000-6-2
	Voltage dips and interruptions: BS EN 61000-4-11, called by BS EN61000-6-2
	Mains harmonics: BS EN 61000-3-2 A2
	Pumps and pump units for liquids - common safety requirements: BS EN 809
	Other standards
CAN/CSA-C22.2 No 61010-1	
Conducted emissions FCC 47CFR, Part 15.107	
Radiated emissions FCC 47CFR, Part 15	
NEMA 4X to NEMA 250 (indoor use) for IP66 products only	

8.1 Dimensions

520UN IP66/NEMA 4X model



Unit weights

	Drive only	+ 520R, 520R2	+ 520REL, 520REM, 520REH	+ 505L
IP66 NEMA 4X	9.78kg 21lb 9oz	10.68kg 23lb 9oz	10.60kg 23lb 8oz	12.26kg 27lb

9 Good pump installation practice

9.1 General recommendations

A correctly engineered installation will promote long tube life. Site the pump on a flat, horizontal, rigid surface, free from excessive vibration, to ensure correct lubrication of the gearbox. Allow a free flow of air around the pump to ensure that heat can be dissipated. Ensure that the ambient temperature around the pump does not exceed 40C.

The **STOP** key on the keypad will always stop the pump. However, it is recommended that a suitable local emergency stop device is fitted into the mains supply to the pump.

Do not stack pumps more than three high. When pumps are stacked, ensure that the ambient temperature around all the pumps in the stack does not exceed 40C.

The pump may be set up so that the direction of rotor rotation is clockwise or counter-clockwise, whichever is convenient. Please note, however, that for the 520R and 501RL pumpheads tube life will be greater if the rotor rotates clockwise; and that performance against pressure will be maximised if the rotor rotates counter-clockwise. To achieve 4 bar and 7 bar pressures using a 520RE pump and the appropriate rotor and element, the pump **must** rotate counter-clockwise.

Peristaltic pumps are self-priming and self-sealing against backflow. No valves are required in inlet or discharge lines, except as described below. Valves in the process flow must be opened before the pump operates. Users are advised to fit a pressure relief device between the pump and any valve on the discharge side of the pump to protect against damage caused by accidental operation with the discharge valve closed. Users of 520RE pumps at pressures up to 4 bar and 7 bar are advised to fit a non-return valve between the pump and the discharge pipework to avoid the sudden release of pressurised fluid in the unlikely event of element failure.

9.2 Do's and do not's

Do not build a pump into a tight location without adequate airflow around the pump.

Do ensure that whenever the 520N watertight module is fitted the seals are intact and properly located.

Do ensure that the holes for cable glands are properly sealed to maintain the IP66/NEMA 4X rating.

Do not strap the control and mains power cables together.

Do keep delivery and suction tubes as short and direct as possible - though ideally not shorter than 1m - and follow the straightest route. Use bends of large radius: at least four times the tubing diameter. Ensure that connecting pipework and fittings are suitably rated to handle the predicted pipeline pressure. Avoid pipe reducers and lengths of smaller bore tubing than the pumphead section, particularly in pipelines on the suction side. Any valves in the pipeline (not usually needed with a self-priming peristaltic pump) must not restrict the flow. Any valves in the flow line must be open when the pump is running.

Do use suction and delivery pipes equal to or larger than the bore of the tube in the pumphead. When pumping viscous fluids use pipe runs with a bore several times larger than the pump tube.

Do ensure that on longer tube runs at least 1m of smooth bore flexible tubing is connected to the inlet and discharge port of the pumphead to help to minimise impulse losses and pulsation in the pipeline. This is especially important with viscous fluids and when connecting to rigid pipework.

Do site the pump at or just below the level of the fluid to be pumped if possible. This will ensure flooded suction and maximum pumping efficiency.

Do keep the pumphead track and all moving parts clean and free from contamination and debris.

Do run at slow speed when pumping viscous fluids. When using the 520R pumphead, a 6.4mm or 4.8mm bore tube with a 2.4mm wall will give best results. Tube smaller than this will generate a high friction loss, so reducing the flow. Tube with a larger bore may not have sufficient strength to restitute fully. Flooded suction will enhance pumping performance in all cases, particularly for materials of a viscous nature.

Do recalibrate after changing pump tubes, fluid, or any connecting pipework. It is also recommended that the pump is recalibrated periodically to maintain accuracy.

IP66/NEMA 4X models may be hosed down, but should not be immersed. Protect from prolonged UV exposure.

When using Marprene or Bioprene continuous tubing, **do** re-tension the tube after the first 30 minutes of running.

Tube selection: The chemical compatibility lists published in Watson-Marlow publications are guides. If in doubt about the compatibility of a tube material and the duty fluid, request a Watson-Marlow tube sample card for immersion trials.

10 Connecting this product to a power supply



The voltage selector is mounted in the switchplate at the rear of the pump, protected from water by the 520N module. The module must be removed to allow access to the switchplate. See 21.1 *520N module removal and replacement*. Set the voltage selector to 115V for 100-120V 50/60Hz supplies or 230V for 200-240V 50/60Hz supplies. Always check the voltage selector switch before connecting the mains supply.

Make suitable connection to an earthed single-phase mains electricity supply.



The voltage selector switch is not visible while the 520N module is in place. Do not switch the pump on unless you have checked that it is set to suit your power supply by removing the module and inspecting the switch, and then refitting the module. See 21.1 *520N module removal and replacement*.



We recommend using commercially available supply voltage surge suppression where there is excessive electrical noise.

Power cable: The pump is supplied fitted with a cable gland and approximately 2.8m of power cable. Recommended cable: H05RN-F3G0.75; SJTW 105C 3-18AWG; max OD 8mm (5/16in).

This drawing shows the cable connections from below with the interface card cover removed.

Power cables of NEMA 4X specification pumps are fitted with a standard US mains power plug. IP66 specification pumps are supplied with no plug. The colour code for the power cable is: brown - live; blue - neutral; green and yellow - earth.

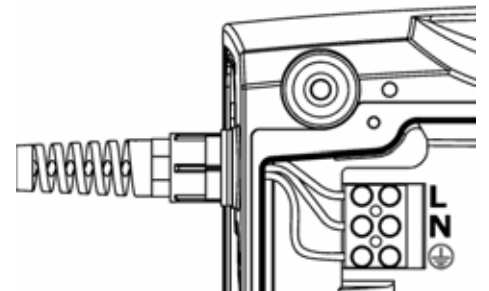

If the mains power cable is inappropriate for your installation, it can be changed. This operation can be carried out with the 520N module in place, or after it has been removed, as shown here for clarity.

- Ensure that the pump is isolated from the mains power.



- Remove the six screws from the interface card cover underneath the pump. Lift off the interface card cover. You may find it convenient to remove the cover completely; if so, remove the cover earth lead.
- Undo the terminal block connectors. Remove the restraining clip by sliding its jaws sideways in opposite directions.
- Loosen the cable gland using a 19mm wrench and remove the gland and the cable.
- Thread a replacement cable through the three parts of the gland, the pump case and the restraining clip. Connect the new cable to the block connectors, following the drawing above.
- Tighten the restraining clip and the gland to 2.5Nm. Check that the card cover earth link is secure. Replace the card cover, checking that the earth wire is not pinched beneath the cover lip. Take care that the sealing strip is properly seated to ensure a seal.



Input line fusing: type T2,5A H 250V 20mm time-delayed fuse, located in a fuseholder in the centre of the switchplate at the rear of the pump.

Power interruption: This pump has an auto-restart feature which, when active, will restore the pump to the operating state it was in when power was lost. See 16.6 *Auto-restart*.

Stop / start power cycles: Do not power up/power down for more than 100 starts per hour, whether manually or by means of the auto-restart facility. We recommend remote control where a high frequency of power cycles is required.

11 Start-up check list

Note: See also 27.2 *Tube loading*.

- Ensure that proper connections are achieved between the pump tube and suction and discharge piping.
- Ensure proper connection has been made to a suitable power supply.
- Ensure that the recommendations in the section on 9 *Good pump installation practice* are followed.

12 Switching the pump on for the first time

Note: This manual uses **bold** type to highlight the active option in menu screens: “**English**” in the first screen represented here. The active option appears on the pump display in **inverse** text.

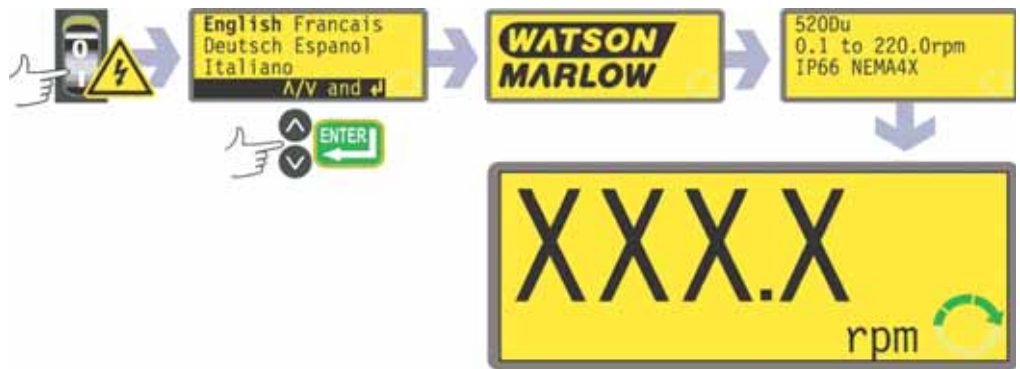

- Switch on the power supply at the rear of the pump. The pump runs a power-on test to confirm proper functioning of the memory and hardware. If a fault is found, an error message is displayed. See 23.1 *Error codes*.
- The pump displays a language menu. Use the **UP** and **DOWN** keys to select your language. Press the **ENTER** key to confirm your choice.
The information which follows assumes that your choice was English. When the language is chosen this menu will not appear again and all menus will appear in the language you chose. (Language can be reset as described later. See 16.10 *Language*.)
- The pump displays the Watson-Marlow start-up screen for four seconds, followed by the pump model identity screen for four seconds, and then the manual mode main screen.
- The rotation symbol on the display indicates clockwise rotation. The speed of rotation is the pump’s maximum. Other initial start-up operational parameters are listed in the table below.

First-time start-up defaults			
Language	Not set	Analogue input	4-20mA
Speed	Maximum	User trim	None
Direction	Clockwise	Remote stop	Open=run
Calibration	520R2 9.6mm tube	Output 1	Run/Stop *
Backlight	On	Output 2	Direction †
Keypad lock	Off	Output 3	Auto/Man ‡
Auto-restart	Off	Output 4	General alarm
Pump status	Stopped		
Beeper	On	Run *	= High
Manual screen	rpm	Clockwise rotation †	= High
Security code	Not set	Auto ‡	= High

Note: The settings shown above for Run, Clockwise rotation and Auto are those in force on initial start-up for the functions available on Output 1, Output 2 and Output 3 respectively. For example, a high signal on Output 2 indicates clockwise rotation. These can be exchanged later according to user requirements.

Note: High is equivalent to the common and normally open contacts of the relay on the adapter board being closed.

The pump is now ready to operate according to the defaults listed above.

All operating parameters may be changed by means of key-presses. See 14 *Manual operation*.

13 Switching the pump on in subsequent power cycles (if not in auto-restart mode)

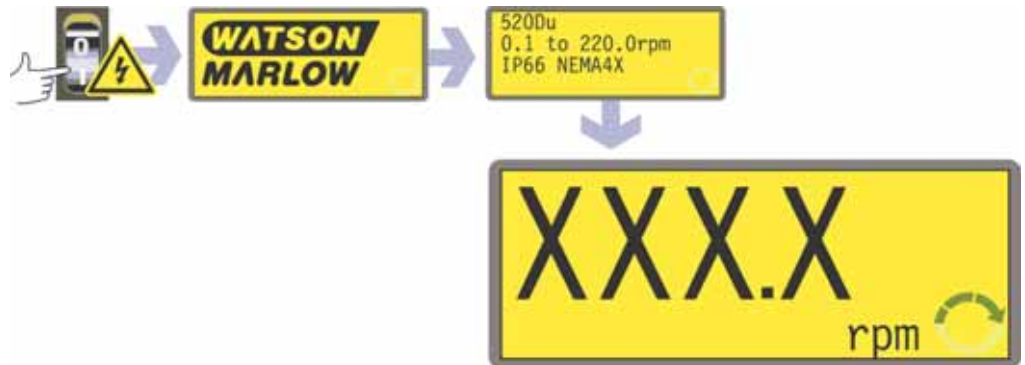

- Switch on the power supply at the rear of the pump. The pump runs a power-on test to confirm proper functioning of the memory and hardware. If a fault is found, an error message is displayed. See 23.1 *Error codes*.
- The pump displays the Watson-Marlow start-up screen for four seconds followed by the pump model identity screen for four seconds, and then the manual mode main screen.
- **Note:** If ANY key is pressed during the display of any of the preliminary screens, the display jumps to the next screen. Quickly pressing any two keys or any key twice immediately after switch-on causes the display to jump to the manual mode main screen. Once in the manual mode main screen, keys assume their normal functions - see 14.1 *Keypad functions in manual mode* below. A subsequent press on START causes the pump to operate.
- Start-up defaults are those in place when the pump was switched off last. Check that the pump is set to operate as you require it.

The pump is now ready to operate.

All operating parameters may be changed by means of key-presses. See 14 *Manual operation*.

14 Manual operation

14.1 Keypad functions in manual mode

All settings and functions of the pump in manual mode are set and controlled by means of key-presses. Immediately after the start-up display sequence detailed above, the manual mode main screen will be displayed. The currently selected rotation direction is indicated on the display by a clockwise or counter-clockwise segmented arrow. If an exclamation mark (!) shows, it indicates that Auto-restart is on (see 16.6 *Auto-restart*). If a padlock icon (🔒) shows, it indicates that Keypad lock is on (see 14.2 *Keypad lock*).

Note: A number of the controls listed below are shortcuts to commands which are also available through the Main menu. See 15 *Main menu*.



A brief single press on each key triggers a beep sound (if enabled - see 14.3 *Keypad beep*) and causes the pump to function as follows:

- **START:** starts the pump at the speed and in the direction shown on the dis-

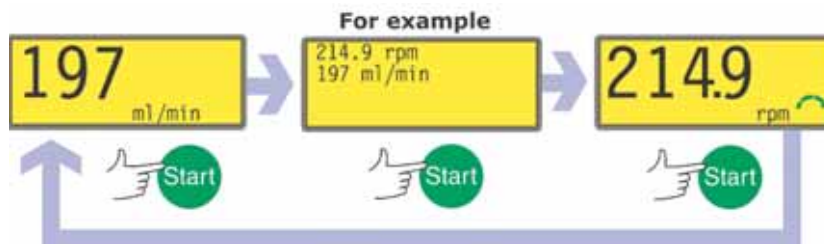

play. The rotation symbol will become animated to confirm that the pump is operating. We recommend that the speed is reduced to a minimum (0.1 rpm) before starting the pump.

If the pump is running when **START** is pressed, it causes the information shown on the manual mode main screen to cycle from revolutions per minute, to flowrate in millilitres per minute (via a warning screen if flowrate has not been calibrated and if this is the first cycle since power-up) to both rpm and flowrate. See 18 *Calibration*.

- **MAX:** while pressed, **MAX** operates the pump at the maximum allowed speed and in the direction shown on the display. When released, the pump returns to its previous status.
Note: Priming can be achieved by pressing the **MAX** key until fluid flows through the pump and reaches the point of discharge, and then releasing the **MAX** key.
- **AUTO/MAN:** toggles the pump into analogue control. When started, the pump runs at the speed set by any analogue signal applied to the pump, and in the direction shown in the display.
- **STOP:** has no effect if the pump is not running. If the pump is running, pressing **STOP** stops the pump. The display will continue to show the previous speed and direction. The pump will return to this speed and direction when the **START** key is pressed again.
- **UP:** increases the speed shown on the display in minimum steps of 0.1 rpm (unless the speed displayed is already the maximum allowed speed). If the pump is then started by pressing the **START** key, it will operate at the new speed. If the pump is running when **UP** is pressed, the change takes effect immediately.
Note: After a speed change (as long as the pump has been calibrated), a screen showing the new rpm figure **and** the new flowrate is displayed for four seconds before returning the user to the previously set manual mode main screen: rpm **or** flowrate.
- **DOWN:** decreases the speed shown on the display in minimum steps of 0.1 rpm. If the pump is then started by pressing the **START** key, it operates at the new speed. The minimum speed possible is 0.1 rpm. If the pump is running when **DOWN** is pressed, the change takes effect immediately.
Note: After a speed change (as long as the pump has been calibrated), a screen showing the new rpm figure **and** the new flowrate is displayed for four seconds before returning the user to the previously set manual mode main screen: rpm **or** flowrate.
Note: You can reduce the pump speed from 0.1 rpm to 0 rpm by a further press on the **DOWN** key. The pump is still in the running state and the rotation symbol will continue to move. Press the **UP** key to return the pump to the minimum speed.
- **DIRECTION:** toggles the direction of rotation shown on the display. If the pump is then started by pressing the **START** key, it rotates in the new direction. If the pump is running when **DIRECTION** is pressed, the change takes effect immediately.

- **ENTER**: cycles the information shown on the manual mode main screen from revolutions per minute, to flowrate in millilitres per minute (via a warning screen if flowrate has not been calibrated) to both rpm and flowrate. (See **START**, above. See 18 *Calibration*.) This cycle operates when the pump is stopped and when it is running. The default can be altered from within the Setup menu. See 16.3 *Display*.
- **MENU**: causes the main menu to be displayed, from which all aspects of pump setup can be controlled, including the MemoDose facility. See 15 *Main menu*.

Keypress combinations cause the pump to function as follows:

- **UP** and **DIRECTION** on power-up: toggles the keypad beep on and off.
- **START** on power-up: switches on the Auto-restart facility. See 16.6 *Auto-restart*.
- **STOP** on power-up: switches off the Auto-restart facility. See 16.6 *Auto-restart*.
- **STOP** and **DIRECTION** on power-up: allows the user to press **UP** and **DOWN** keys to toggle the sense of remote run / stop control between open=stop and open=run.
- **STOP** and **UP** while the pump is stopped: turns the display backlight on.
- **STOP** and **DOWN** while the pump is stopped: turns the display backlight off.
- **MAX** and **UP**: sets the pump to maximum allowed speed.
- **MAX** and **DOWN**: sets the pump to minimum speed.
- **DIRECTION** and **DOWN**: interrupts the display to show the pump's ROM version for four seconds.
- **START** pressed and held for two seconds: toggles the keypad lock on and off. Only the **START** and **STOP** keys are active when keypad lock is on. The pad-lock icon is displayed.
- **STOP** pressed and held for two seconds: toggles the keypad lock on and off. Only the **START** and **STOP** keys are active when keypad lock is on. The pad-lock icon is displayed.
- **STOP STOP** within half a second: shortcut entry to the MemoDose menu; when in MemoDose, shortcut return to manual mode main screen. See 17 *MemoDose*.

Note: The maximum allowed speed of the drive defaults to 220 rpm. It is possible to set this limit at any speed up to this value. See 16.7 *Set maximum speed*.

14.2 Keypad lock

The keypad can be locked to prevent changes to pump speed or other settings, and make it possible only to start or stop the pump. The padlock symbol shows on the display.

- While the pump is running, hold down the **START** key for two seconds. The padlock symbol shows and only the **START** and **STOP** keys function.
- The keypad may also be locked while the pump is stopped. Hold down the **STOP** key for two seconds. The padlock symbol shows and only the **START** and **STOP** keys function.
- To unlock the keypad while the pump is running hold down the **START** key for two seconds. The padlock symbol is removed. If the pump is stopped hold down the **STOP** key until the padlock symbol is removed.

14.3 Keypad beep

The pump keypad can operate silently or indicate a positive key-press with a beep sound.

- To toggle the sound on and off, stop the pump. Turn off the mains power switch at the rear of the pump.
- Depress the **UP** and **DIRECTION** keys while switching on the mains power switch at the rear of the pump.

14.4 Manual operation and remote digital inputs and outputs

The remote run / stop, direction and leak-detected inputs are operational.

The remote status outputs are all fully functional.

The **STOP** key acts as an overriding emergency stop. The run / stop input will not start the pump in manual mode, but once the **START** key has been pressed, the remote run / stop input will stop and start the pump according to its operational state.

If you invert the operation of the remote run / stop switch to operate as open=stop, you must connect the **+5V** terminal to the **i/p** terminal on the Run/stop input connector (J4), to be able to start the pump from the keypad.

If **STOP** is pressed the remote run / stop switch will have no effect.

You cannot invert the polarity of the remote direction signal.

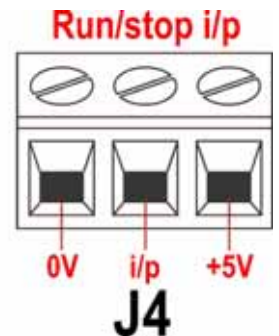

15 Main menu

15.1 Keypad functions in menu screens

In addition to their functions in other operations, the following keys have specific actions in menu screens:

- **STOP**: In general, **STOP** functions as a "go back" key, taking the user up one menu level without making a change.
- **UP**: The **UP** key is used in menu item selection: it moves a highlight up the menu. When a numerical entry screen is displayed, pressing **UP** increases the number displayed.
- **DOWN**: The **DOWN** key is used in menu item selection: it moves a highlight down a menu. When a numerical entry screen is displayed, pressing **DOWN** decreases the number displayed.
- **ENTER**: The **ENTER** key functions in a similar way to the "enter" key of a personal computer: it confirms key-presses made immediately before. In menu item selection, it triggers the action or display selected from a menu using the **UP** and **DOWN** keys.



Note: Confirmation screens are displayed for 4 seconds. While they are displayed, a single press on any key removes them.

15.2 Main menu entry

The **MENU** key displays the main menu. It operates at any point in the pump's activity except where error screens are displayed, or screens where **UP** and **DOWN** keys are used to enter values.



The main menu offers four options: **Setup**, **MemoDose**, **Pin out details** and **Exit**. Use the **UP** and **DOWN** keys to make a choice. Press the **ENTER** key to confirm your decision.

Setup

Setup allows the user to set the pump's operating parameters under 12 headings: **Trim**, **Analogue**, **Display**, **Outputs**, **Remote stop**, **Auto-restart**, **Set max speed**, **Backlight**, **ROM**, **Language**, **Defaults** and **Security code**.

MemoDose

The **MemoDose** facility is used to remember the number of revolutions needed to dispense a set volume of fluid, and cause the pump to dispense that volume repeatedly. This menu also gives access to the **Calibration menu**, where the user can calibrate the flowrate.

Pin out details

Pin out information is not relevant to the 520UN IP66/NEMA 4X pump. Selecting **Pin out details** causes the pump to display a warning screen and redisplay the main menu.

Exit

If **Exit** is selected, the pump returns to its last manual state with the pump stopped.

16 Setup

The pump can be configured to limit access to the setup parameters to users who correctly enter a three-digit security code. **Note:** The security code can be set, changed or removed from within the Setup menu. See 16.12 *Security code*.

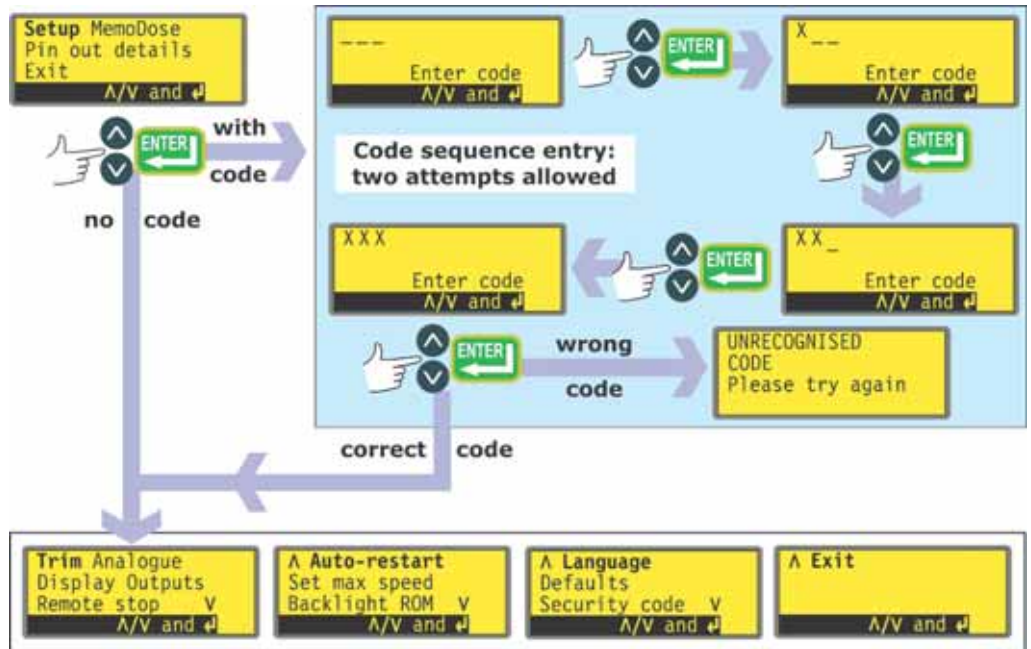

If a security code has not been set

When no security code has been set, selecting **Setup** and pressing **ENTER** causes the pump to display the first section of the Setup menu.

If a security code has been set

When a security code is in place, selecting **Setup** and pressing **ENTER** causes the pump to display a screen with three blank spaces for digits and the instruction "Enter code". Use the **UP** and **DOWN** keys to make your choice of the digits 0-9 for the first digit. Press **ENTER** to confirm. Repeat for the second digit. Repeat for the third digit. The final press on **ENTER** causes the pump to display the first section of the Setup menu.

If the three-digit code entered is incorrect, the pump briefly displays an error message and redisplay the first digit-entry screen. If a second attempt fails, the pump briefly displays an error message and returns the user to the manual mode main screen.

The Setup menu

The Setup menu occupies four screens.

To move from one screen to subsequent screens,

repeatedly press **DOWN**. Each item is highlighted in turn until the last item on the screen is highlighted.

A further press on the **DOWN** key displays the next screen of the menu, with the first item highlighted.

Follow the reverse procedure using the **UP** key to move to an item on a previous screen of the menu.

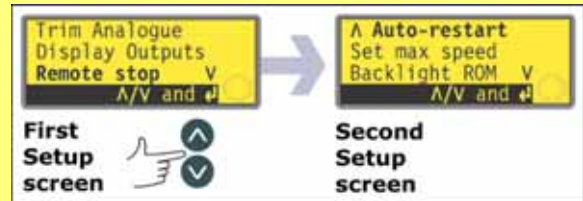

Make a selection using the **UP** or **DOWN** keys and press **ENTER** to confirm your choice.

16.1 Trim

When the pump is under remote control, it tracks an analogue signal from the user's remote control system to the **i/p** terminal of the Analogue 1 connector at the rear of the pump within the ranges 4-20mA or 0-10V. The **Trim** setup is used to calibrate the pump to an analogue control system. The sequence may be entered directly from the Setup menu or from the Analogue setup menu.

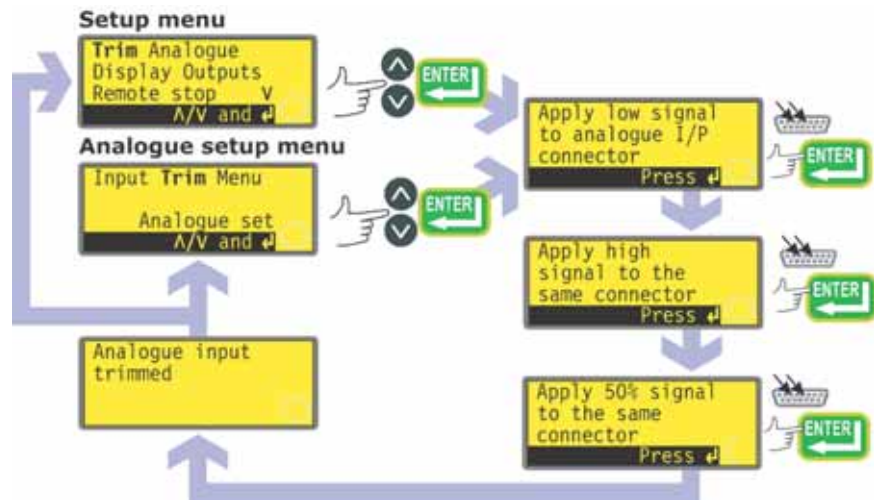

- Select **Trim** from the Setup menu or the Analogue setup menu using the **UP** or **DOWN** keys and press **ENTER** to confirm your choice.
- Apply the low process analogue signal to the **i/p** terminal of the Analogue 1 connector as instructed in the display. See 16.2 *Analogue*. While the signal is being applied, press **ENTER** to record the signal as a calibration point.
- Apply the maximum process control signal. While the signal is being applied, press **ENTER** to record the signal as a calibration point.
- Apply 50% of the maximum process control signal. While the signal is being applied, press **ENTER** to record the signal as a calibration point.
- If a mistake is made, the user may press **STOP** at any point in the sequence, and the pump displays the previous screen.
- The final press on **ENTER** causes the pump to display a confirmation screen and then redisplay the screen from which it entered the trim sequence: the Setup menu or the Analogue setup menu.

The pump then calculates a linear response from low to mid and from mid to high, and records the result as a new analogue input calibration graph.

If any of the three applied signals match, a warning screen is displayed before the confirmation screen appears, and the trim is ignored.

Note: By applying the maximum process control signal when the minimum is requested and vice versa, an inverted response can be set up.

16.2 Analogue

When the pump is under remote control, it tracks an analogue signal from the user's remote control system to the **i/p** terminal of the Analogue 1 connector at the rear of the pump within the ranges 4-20mA or 0-10V. The **Analogue** option in the Setup menu allows the user to configure the pump to operate with his remote control system.



- Select **Analogue** from the Setup menu using the **UP** or **DOWN** keys and press **ENTER** to confirm your choice.
- Three options are displayed: **Input**, **Trim** and **Menu**.

Input allows the user to tell the pump which signal type he will apply, or to choose the program option. If he selects **Program** from the subsequent menu, the user can choose his input type and tell the pump the speeds at which to operate on receiving a low or high process control signal. See *Input*.

Trim displays the Trim menu, described above. See 16.1 *Trim*.

Menu returns the user to the first section of the Setup menu. See 16 *Setup*.

Input

- Select **Input** using the **UP** or **DOWN** keys and press **ENTER** to confirm your choice.
- The pump will offer two further choices: **4-20mA** and **0-10V**. Use the **UP** or **DOWN** keys to make a selection and press **ENTER** to confirm your decision.

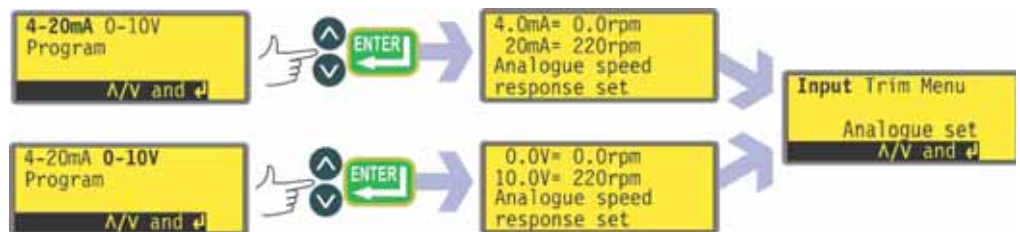

- The pump configures the hardware and factory-set response data and briefly displays a confirmation screen. The user is returned to the analogue setup display.
- Alternatively the user can select **Program** to configure the pump to respond in a user-programmed way to any process signal range within the limits described above.

Program

- Select **Program** using the **UP** or **DOWN** keys and press **ENTER** to confirm your choice.
- The pump will offer two choices: **mA** and **V**. Use the **UP** or **DOWN** keys to make a selection and press **ENTER** to confirm your decision.

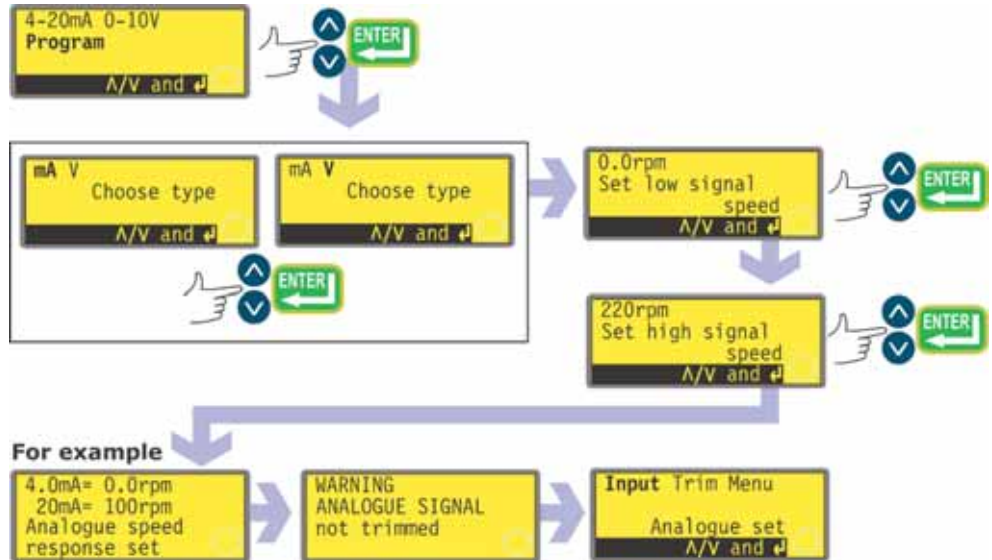

- The pump displays a screen allowing you to set the speed for low signal input. Use the **UP** and **DOWN** keys to scroll the display to your chosen speed and press **ENTER** to confirm the figure.
- The pump displays a screen allowing you to set the speed for high signal input. Use the **UP** and **DOWN** keys to scroll the display to your chosen speed and press **ENTER** to confirm the figure.
- If a mistake is made, the user may press **STOP** at any point in the sequence (before pressing **ENTER** on the high signal speed screen), and the pump will display the previous screen.
- The final press on **ENTER** causes the pump to configure the hardware and programmed response data. It briefly displays a confirmation screen and a warning that the analogue signal is not trimmed, and returns the user to the Analogue setup menu.

It is recommended that a trim calibration is always performed to align the pump's response to the actual process analogue signal.

Menu

Menu returns the user to the first section of the Setup menu, described above. See 16 *Setup*.

16.3 Display

Either of two standard default screens can be displayed by the pump in manual mode: revolutions per minute or flowrate in millilitres per minute.

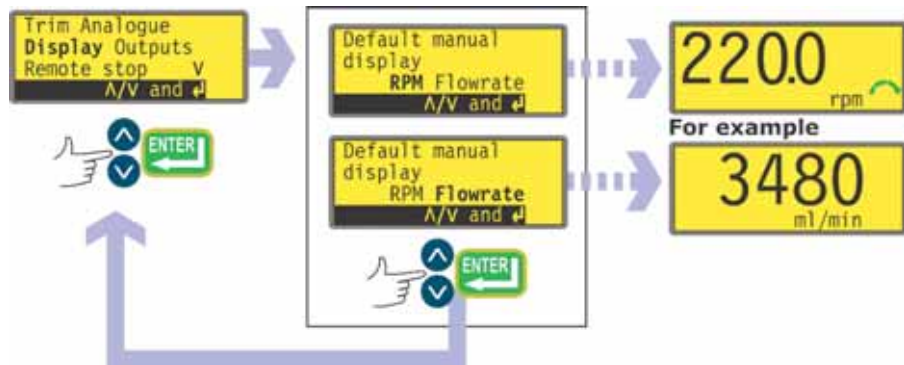

- In the first screen of the Setup menu select **Display** using the **UP** and **DOWN** keys. Press **ENTER** to confirm your choice.
- The pump displays a screen allowing you to choose the format of the manual mode main screen. Use the **UP** and **DOWN** keys to choose and press **ENTER** to confirm your decision.
- The pump redisplay the first screen of the Setup menu.
- When the pump next runs, the manual mode main screen will display pump activity in rpm or ml/min, according to your choice.

Note: A third display option is available: showing rpm **and** flowrate. See *Alternatively*, next.

Alternatively ...

- In the manual mode main screen, repeatedly press **ENTER** to cycle the display between rpm, ml/min or both, according to your choice. This cycle operates if the pump is running and if it is stopped. While the pump is running, you can cycle the display in the same way by repeatedly pressing **START**.

16.4 Outputs

The 520UN pump offers four relay status outputs. See 12 *Switching the pump on for the first time* for initial start-up defaults. Each of five parameters can be configured to any output, or more than one output.

The parameters are:

Run / stop

Provides a status output to indicate whether the pumphead is in a running or stopped condition. When running at 0rpm, the run / stop output indicates running.

Direction

Provides a status output to indicate which direction the pump is set to run in.

Auto / man

Provides a status output to indicate whether the pump is in analogue control mode or manual control mode.

General alarm

Provides an alarm output when any system error condition occurs except: leak detected; analogue signal out of range; analogue over-signal; analogue no signal.

Leak detected

When used with a leak detector, this output provides an alarm when the pump has been automatically switched off following tube failure.

Outputs 1-4 are available as single-pole change-over relay contacts: Relay 1, 2, 3 and 4. Connect to the normally open or normally closed contacts of the relay as required and configure the pump's software accordingly. See below in this section.

Note: The maximum rating on the relay contacts of this pump is 30VDC; maximum load 30W.

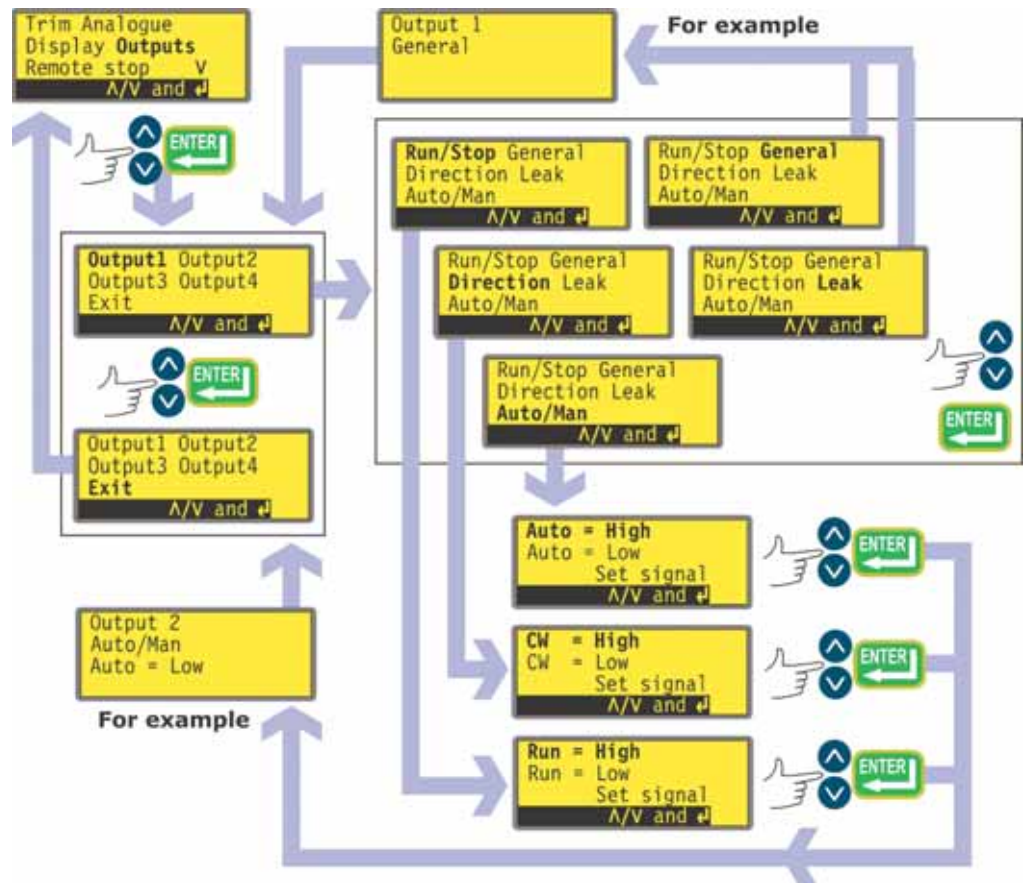

- In the first screen of the Setup menu select **Outputs** using the **UP** and **DOWN** keys. Press **ENTER** to confirm your choice.
- The pump displays a screen allowing you to configure each of the four outputs, or to exit this menu. Use the **UP** and **DOWN** keys to choose and press **ENTER** to confirm your decision.
- If **Output 1** is chosen, the pump displays the five options.
 - Selecting **General** or **Leak** using the **UP** and **DOWN** keys and confirming the choice by pressing **ENTER** configures that option to Output 1, displays a confirmation screen, and returns the user to the Output selection screen.
 - Selecting **Run/Stop**, **Direction** or **Auto/Man** using the **UP** and **DOWN** keys and confirming the choice by pressing **ENTER** displays screens allowing the user to configure Run to **High** or **Low**, Clockwise to **High** or **Low**, and Auto to **High** or **Low** respectively. Choose using the **UP** and **DOWN** keys and press **ENTER** to confirm. The option chosen is configured to Output 1. The pump displays a confirmation screen, and returns the user to the Output selection screen.
- The user can configure **Output 2**, **Output 3** and **Output 4** in the same way, or choose **Exit**.
- If **STOP** is pressed during configuration, the previous setting for the output is retained and the pump redisplay the Output selection screen.
- If **Exit** is chosen, the pump returns the user to the first screen of the Setup menu.

16.5 Remote stop

The 520UN pump can be started and stopped with a remote switch between the 5V terminal and the **i/p** terminal of the Run/stop input, using an open=run or open=stop command sense. It also operates with a logic input between 5V and 24V on the i/p terminal of the Run/stop input. Disabling the remote stop control does not disable other remote controls.

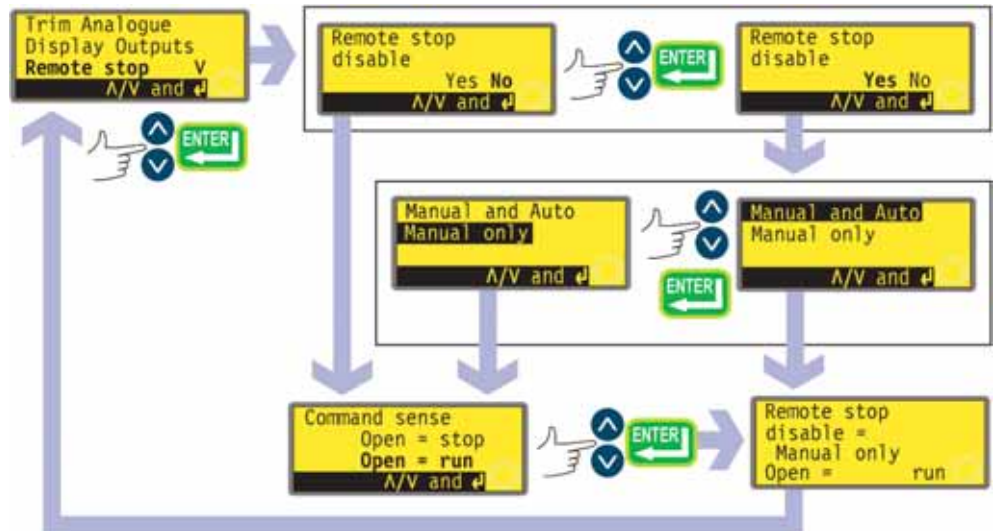

- In the first screen of the Setup menu select **Remote stop** using the **UP** and **DOWN** keys. Press **ENTER** to confirm your choice.
- The pump displays a screen allowing the user to disable the remote stop feature. Use the **UP** and **DOWN** keys to choose **Yes** or **No** and press **ENTER** to confirm the decision.
- If **No** is chosen, the pump asks the user to make a further choice, according to whether the pump is required to run on an open or closed remote switch: **Open=stop** or **Open=run**. Choose using the **UP** and **DOWN** keys and press **ENTER** to confirm. The pump briefly displays a confirmation screen (an example is shown here) and returns the user to the first screen of the Setup menu.

- If **Yes** is chosen, the pump asks the user whether the remote stop feature is to be disabled fully (for both manual and auto operation), or only for manual operation, leaving remote stop functioning when the pump is operating in auto mode. Choose using the **UP** and **DOWN** keys and press **ENTER** to confirm. If manual and auto was chosen, the pump briefly displays a confirmation screen (an example is shown here) and returns the user to the first screen of the Setup menu. If manual only was chosen, the pump asks the user to make a further choice, according to whether the pump (with remote control available in auto mode only) is required to run on an open or closed remote switch: **Open=stop** or **Open=run**. Choose using the **UP** and **DOWN** keys and press **ENTER** to confirm. The pump briefly displays a confirmation screen (an example is shown here) and returns the user to the first screen of the Setup menu.
- **Note:** The confirmation screen indicates whether Remote stop is enabled or disabled, and displays the command sense of the remote control switch **even if Remote stop has been disabled**.



Even with the remote stop function disabled, the pump could still start if the remote auto/manual toggle input is used to toggle the pump into analogue mode.

Alternatively ...

- To toggle the sense of the remote run / stop control between open=stop and open=run: stop the pump. Turn off the mains power switch at the rear of the pump.
- Hold down the **STOP** key and the **DIRECTION** key, and turn on the mains power switch.

16.6 Auto-restart

This pump offers an auto-restart feature. If active on power loss, it restores the pump when power returns to the operating state it was in when power was lost. It does not operate when powering down in the middle of a dose: when the pump is restarted, it will await a press on the **START** key to begin the interrupted dose again. Auto-restart is retained while the pump is switched off. When the pump starts running, look for the ! symbol on the display. This ! symbol indicates that the pump is set for auto-restart.

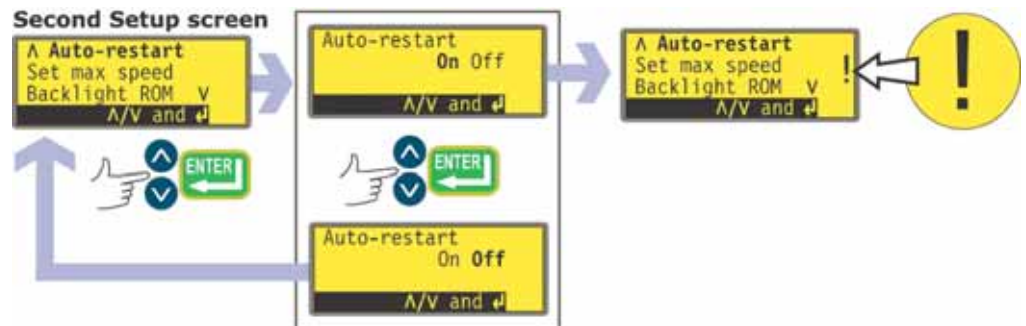

- In the second screen of the Setup menu select **Auto-restart** using the **UP** and **DOWN** keys. Press **ENTER** to confirm your choice.
- The pump displays a screen allowing the user to activate auto-restart. Use the **UP** and **DOWN** keys to choose **On** or **Off** and press **ENTER** to confirm the decision.
- If **Off** is chosen, the pump returns the user to the second screen of the Setup menu. The auto-restart facility will not operate.
- If **On** is chosen, the pump returns the user to the second screen of the Setup menu, where an exclamation mark (!) is now visible. This mark confirms that the auto-restart feature is in place and will operate the next time power is lost and restored.

Alternatively ...

- Stop the pump. Turn off the mains power switch at the rear of the pump.
- Hold down the **START** key and turn on the mains power switch. The ! symbol shows on the display.
- Start the pump. If the mains supply is interrupted the pump will automatically restart when the mains power returns.
- To remove auto-restart switch off the mains power at the rear of the pump. Hold down the **STOP** key and turn the mains power switch on. The ! symbol does not appear.



Do not use auto-restart for more than 100 starts per hour. We recommend remote control where a high number of starts is required.

16.7 Set maximum speed

The 520UN pump offers a maximum speed of 220 revolutions per minute. This limit can be reduced for operational purposes.



- In the second screen of the Setup menu select **Set max speed** using the **UP** and **DOWN** keys. Press **ENTER** to confirm your choice.
- The pump displays a screen allowing the user to set the maximum speed of the pump equal to or lower than the maximum available. Use the **UP** and **DOWN** keys to set the maximum allowed speed and press **ENTER** to confirm the figure.
- The pump returns the user to the second screen of the Setup menu.
- Altering the maximum speed automatically re-scales the analogue speed control response and re-ranges the analogue tacho output signal.

16.8 Backlight

The pump's display can be illuminated or not according to choice.



- In the second screen of the Setup menu select **Backlight** using the **UP** and **DOWN** keys. Press **ENTER** to confirm your choice.
- The pump displays a screen allowing the user to switch the display backlight on or off. Use the **UP** and **DOWN** keys to choose **On** or **Off** and press **ENTER** to confirm the decision.
- The pump returns the user to the second screen of the Setup menu. The display is now illuminated or not according to the user's decision.

Alternatively ...

- To turn the backlight off: press **STOP** and **DOWN** together.
- To turn the backlight on: press **STOP** and **UP** together.

16.9 ROM

The pump can display its software version, model number and pump speed.



- In the second screen of the Setup menu select **ROM** using the **UP** and **DOWN** keys. Press **ENTER** to confirm your choice.
- The pump displays the software version, model number and pump speed for four seconds, then returns the user to the second screen of the Setup menu. It also displays a checksum: CHK 123, for example. This may be required if reporting pump performance to the Watson-Marlow service department.

Alternatively ...

- Press **REVERSE** and **DOWN** together to interrupt the display and show the pump's ROM version for four seconds.

16.10 Language

The pump can be set to operate in several languages.



- In the third screen of the Setup menu select **Language** using the **UP** and **DOWN** keys. Press **ENTER** to confirm your choice.
- In the next screen, choose a language using the **UP** and **DOWN** keys. Press **ENTER** to confirm your choice. The pump redisplay the third Setup screen in your chosen language. All screens will subsequently appear in your chosen language.

16.11 Defaults

All the pump's user-set data can be reset to factory defaults.

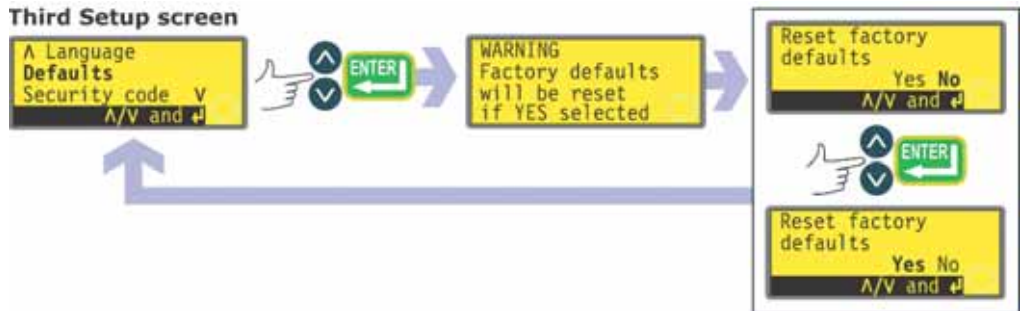

- In the third screen of the Setup menu select **Defaults** using the **UP** and **DOWN** keys. Press **ENTER** to confirm your choice.
- A warning is displayed for four seconds, and the pump asks the user to confirm that factory defaults are to be reset. Use the **UP** and **DOWN** keys to choose **Yes** if you wish the pump to reset all user-set data back to factory defaults (see 12 *Switching the pump on for the first time*); or **No** if you do not wish to do this. Press **ENTER** to confirm your decision. If **Yes** was chosen, the pump will reset its factory defaults and redisplay the third Setup screen. If **No** was chosen, the pump will make no changes to its setup and redisplay the third Setup screen.

16.12 Security code

Access to the pump's Setup menu can be restricted to those who correctly enter a three-digit security code. See 16 *Setup*.

The code must first be set.

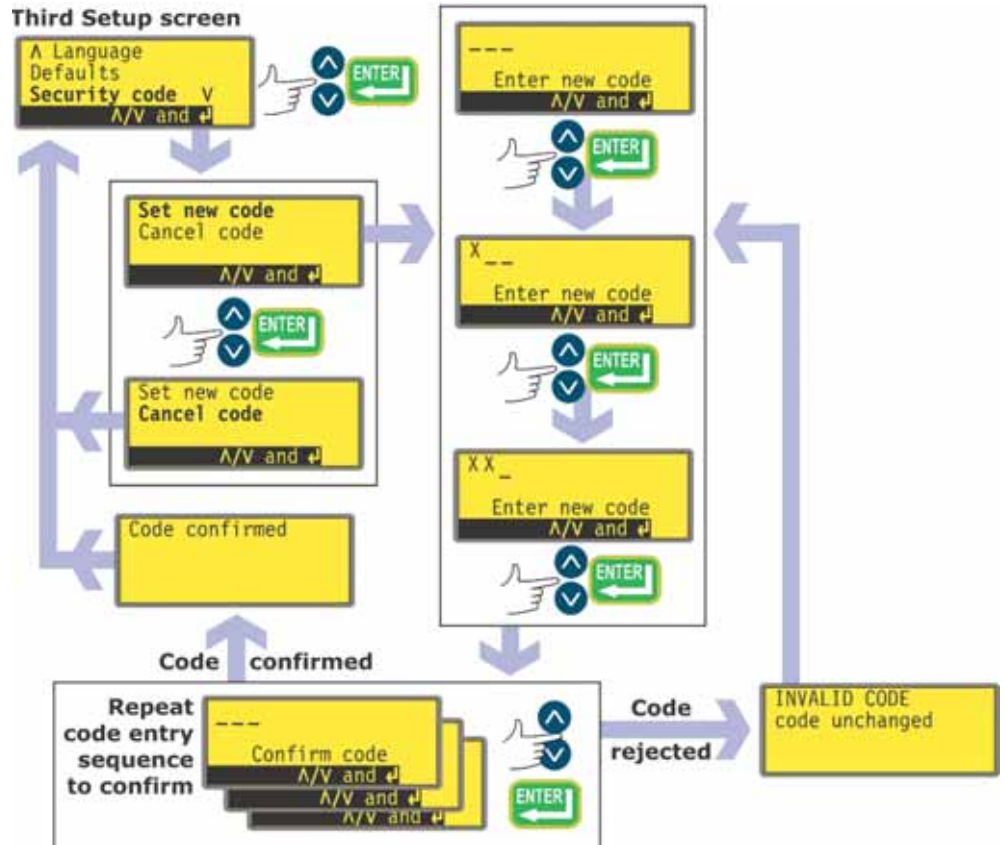

- In the third screen of the Setup menu select **Security code** using the **UP** and **DOWN** keys. Press **ENTER** to confirm your choice.
- A screen is displayed inviting the user to set a new code or, if a code is already set, cancel it. Use the **UP** and **DOWN** keys to choose **Set new code** or **Cancel code**. **If no code is in place, no option to cancel a code will be displayed.** Press **ENTER** to confirm your decision.
- If **Cancel code** is chosen, security protection is removed and the user is returned to the third Setup screen.

- If **Set new code** is chosen, the pump displays a screen with three blank spaces for digits and the instruction "Enter new code". Use the **UP** and **DOWN** keys to make your choice of the digits 0-9 for the first digit. Press **ENTER** to confirm. Repeat for the second digit. Repeat for the third digit. The final press on **ENTER** causes the pump to display a similar three-digit entry screen and the instruction "Confirm code".
- Repeat the digit-entry sequence.
- If the second three-digit code entered differs from the first, the pump will briefly display an error message and redisplay the first digit-entry screen.
- If the codes tally, the pump will briefly display a confirmation message and redisplay the third Setup screen. Access to the Setup menus is now protected by the new security code.
- If **STOP** is pressed during code entry, the pump returns the user to the third Setup screen. If **STOP** is pressed during code confirmation, the pump returns the user to the first digit-entry screen.

Note: If a code has been set but forgotten, it is still possible to access the Setup screens to cancel the code or reset it to another three-digit number. Contact your supplier or Watson-Marlow Technical support for the bypass sequence.

16.13 Exit



- In the fourth screen of the Setup menu **Exit** is highlighted. Press **ENTER**.
- The user is returned to the main menu.

17 MemoDose

Note: This menu area also gives access to flow rate calibration.

Each time the pump is started by pressing **START**, it records the number of pump-head revolutions which occur until **STOP** is pressed. The number of revolutions is proportional to the volume of fluid which has been dispensed: the dose. The MemoDose facility allows the user to repeat-dose a precise volume of fluid. To do so, a quantity of fluid must be dispensed as the master dose which the MemoDose facility can repeat exactly or proportionately.

To dispense a master dose

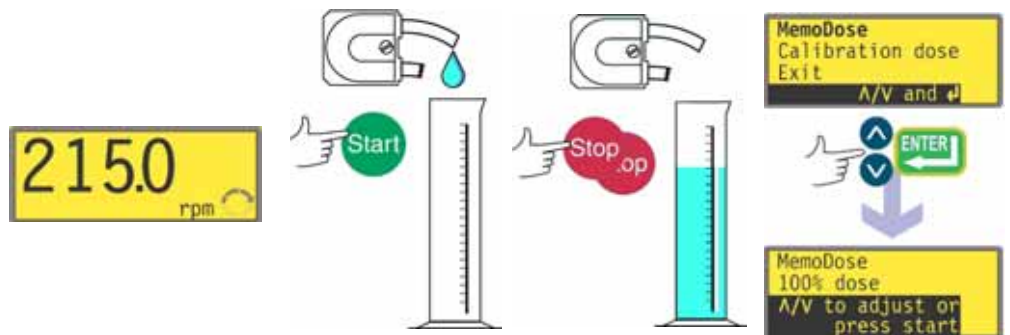

- In the manual mode main screen, set the appropriate pump speed and direction using the **UP** or **DOWN** keys and the **DIRECTION** key. A slower speed may make it easier for the user to measure accurately - though it may not represent the duty condition.
- Place a suitable measuring vessel under the pump delivery tube.
- Press **START**. The pump runs and fluid is pumped into the vessel.
- When the required volume of fluid has been dispensed, it is necessary to stop the pump and display the MemoDose screen. This can be achieved in three ways.
 1. Press the **STOP** key twice within half a second. The pump stops and immediately displays the MemoDose/Calibration screen. Use the **UP** or **DOWN** keys to select **MemoDose**. Press **ENTER** to confirm.
OR...
 2. Press the **STOP** key once. The pump stops. (This may make it easier to ensure that the quantity of fluid that has been dispensed is sufficiently precise.) Then press the **STOP** key twice within half a second. The pump displays the MemoDose/Calibration screen. Use the **UP** or **DOWN** keys to select **MemoDose**. Press **ENTER** to confirm.
OR ...
 3. Press the **STOP** key. The pump stops. Press the **MENU** key. Use the **UP** or **DOWN** keys to select **MemoDose**. Press **ENTER** to confirm. The pump displays the MemoDose/Calibration screen. Use the **UP** or **DOWN** keys to select **MemoDose**. Press **ENTER** to confirm.

To repeat the dose

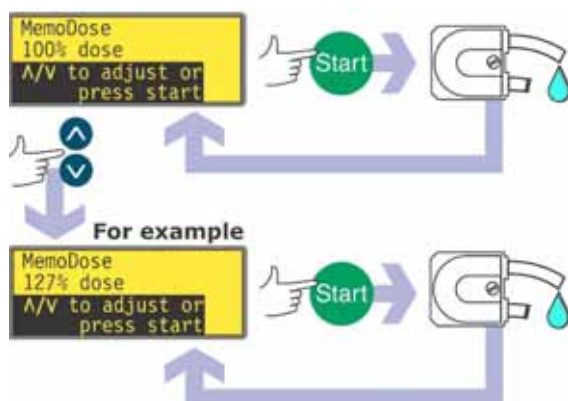

- The pump has recorded the number of pumphead revolutions required to dispense the master dose. If the volume of fluid in the measuring vessel is the volume required, press **START** to repeat the dose.
- If the volume of fluid in the measuring vessel differs from the volume required, the percentage may be adjusted within the limits 1% to 999% of the master dose. Use the **UP** or **DOWN** keys to alter the percentage. Press **START** to dispense the new dose.
- The display counts down as the dose proceeds and stops when the dose is complete.
- If **STOP** is pressed during dosing, the pump stops and returns the user to the MemoDose percentage screen.

Press the **STOP** key twice within half a second if you wish to exit MemoDose and return to manual operation.

17.1 Changing dosing speed

The user must exit MemoDose in order to change pump speed (and direction). After returning to MemoDose, the pump dispenses the previous dose size at the new speed.



- Press the **STOP** key twice within half a second. The pump displays the manual mode main screen.
- **Do not start the pump. Doing so erases the previously recorded master dose and replaces it in the pump's memory with the current, unmeasured dose.** Adjust the speed showing on the display using the **UP** or **DOWN** keys.

- Press the **STOP** key twice within half a second to return to MemoDose. The display shows the previous percentage dose size. The pump will dose at the new speed.

Note: To retain the MemoDose value through a power interruption the pump must be in auto-restart mode. The dosing cycle will resume at the start of a dose and wait for **START** to be pressed, with the MemoDose percentage screen displayed. See 16.6 *Auto-restart*.

17.2 Footswitch operation and other remote inputs and outputs with MemoDose

A footswitch or a momentary contact switch can be used to trigger MemoDose dispensing as a hands-free alternative to pressing **START**.

To install a footswitch, connect it between the **+5V** terminal and the **i/p** terminal of the Dose input connector (J3). Alternatively a logic signal of between 5V and 24V can be applied to the **i/p** terminal of the Dose input connector (J3), ground to the **0V** terminal.

To operate MemoDose with a footswitch, briefly press the footswitch while the MemoDose percentage screen is displayed.

The remote run / stop input is operational. If a dose is interrupted by a remote stop signal, the dose will continue from where it stopped when the state is changed to run.

Remote direction control is disabled. The leak-detection input is operational. All status outputs are operational.

Note: The keypad lock feature is particularly useful to prevent inadvertent dose changes while using the MemoDose facility. Keypad lock continues to operate in MemoDose if previously enabled; it can also be enabled while in MemoDose mode. See 14.2 *Keypad lock*.

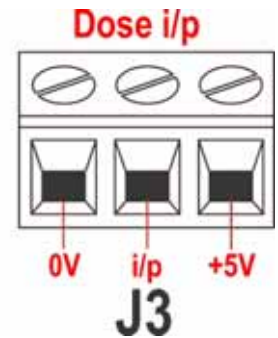

18 Flow calibration

The pump can display flowrate in millilitres per minute as well as speed in revolutions per minute.

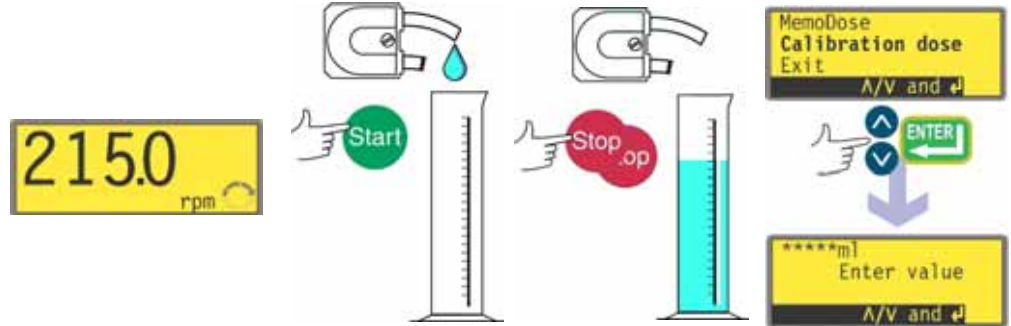

- In the manual mode main screen, set the appropriate pump speed and direction using the **UP** or **DOWN** keys and the **DIRECTION** key. A slower speed may make it easier for the user to measure accurately - though it may not represent the duty condition.
- Place a suitable measuring vessel under the pump delivery tube.
- Press **START**. The pump runs and fluid is pumped into the vessel. The volume pumped is not important; but the greater the volume, the more accurate the flow-per-revolution calculation will be. We suggest that the pumphead be run for at least 10 revolutions, and at least 20 when small-bore pumping tube is used.
- When a volume of fluid has been dispensed, it is necessary to stop the pump and display the Calibration dose screen. This can be achieved in three ways.
 1. Press the **STOP** key twice within half a second. The pump stops and immediately displays the MemoDose/Calibration screen. Use the **UP** or **DOWN** keys to select **Calibration dose**. Press **ENTER** to confirm.
OR...
 2. Press the **STOP** key once. The pump stops. (This may make it easier to ensure that the quantity of fluid that has been dispensed is sufficiently precise.) Then press the **STOP** key twice within half a second. The pump displays the MemoDose/Calibration screen. Use the **UP** or **DOWN** keys to select **Calibration dose**. Press **ENTER** to confirm.
OR ...
 3. Press the **STOP** key. The pump stops. Press the **MENU** key. Use the **UP** or **DOWN** keys to select **MemoDose**. Press **ENTER** to confirm.

The pump displays the MemoDose/Calibration screen. Use the **UP** or **DOWN** keys to select **Calibration dose**. Press **ENTER** to confirm.

- Measure the volume of fluid pumped. Make a note of the volume.
- The pump has recorded the number of pumphead revolutions required to pump the volume of fluid measured.
- The calibration dose screen is displayed. It shows a four-digit number of millilitres, and the instruction: "Enter dose value". The number displayed is the number which was entered the previous time the pump was calibrated (or the default figure).

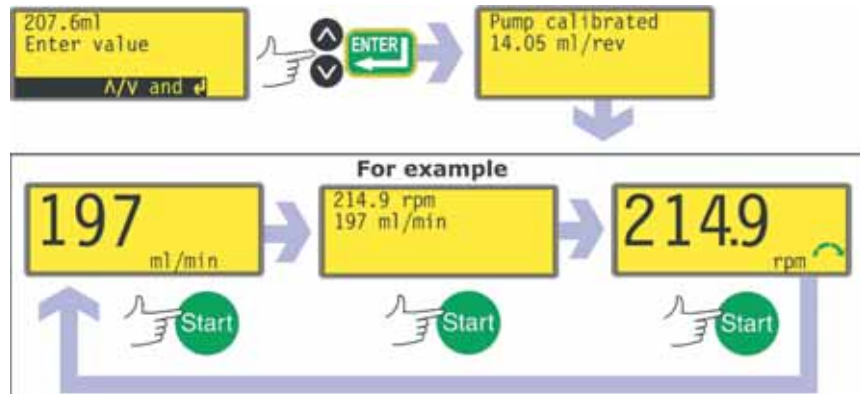

- Use the **UP** and **DOWN** keys to enter the measured volume of fluid pumped. Press **ENTER** to confirm.
- The pump calculates the volume of fluid pumped for each pumphead revolution. The value from this calculation is saved for use in manual mode displays.
- The pump displays a confirmation screen for four seconds, and returns the user to the manual mode main screen, with millilitres per minute shown.
- The pump can now display millilitres per minute, revolutions per minute, or both. Press the **START** key while the pump is running to cycle through the three display options.

Note: Always recalibrate after changing pump tubes, fluid, or any connecting pipework. It is also recommended that the pump is recalibrated periodically to maintain accuracy.

Note: If the pump power is cycled while flow rate is displayed, calibration is lost and a warning is displayed.

18.1 Exit

To return to the manual mode main screen select **Exit** using the **UP** and **DOWN** keys. Confirm by pressing **STOP**.

19 Pin out details

Pin out information is not relevant to the 520UN IP66/NEMA 4X pump. Selecting **Pin out details** causes the pump to display a warning screen and redisplay the main menu.

20 Exit

Press **Exit** in the Main menu to return to the Manual mode main screen.

21 Automatic control wiring

Interfacing the pump with other devices is by means of screw-terminal connectors within the 520N watertight module at the rear of the pump. Suitable cable must be passed into the module through one or more watertight cable glands and connected appropriately. The module must be removed to allow this.



It is important to check the pump's voltage setting to ensure that it matches the supply. The voltage selection switch is on the rear panel of the drive. The module must be removed (and replaced) to allow it to be checked.

21.1 520N module removal and replacement

To remove the 520N watertight module:

The module is secured to the back of the drive unit by six M5x12 Pozidriv counter-sunk stainless steel screws.



- Remove the six screws using a suitable crosspoint screwdriver, leaving the top centre screw till last. Even when all screws have been removed, the sealing strip may cause the module to adhere to the drive. If so, a gentle tap will free it. Do not use a tool to lever it off.
- The sealing strip should be retained within its channel on the face of the module. The transparent on/off switch cover should be retained on its flange on the face of the module. Check the integrity of the seal and the transparent on/off switch cover. If either is damaged, it must be renewed to maintain ingress protection.

- If necessary, unplug the two 25-way D-connectors linking the module to the pump drive. If necessary, remove the module's earth link from the back of the drive. However, the link is long enough to allow the module to fold back to give access to the circuit board inside and to the back of the drive.

To replace the 520N watertight module:



- Check that the fuse in the fuseholder (ringed) in the centre of the switchplate does not need to be replaced. Check that the voltage selector switch is correctly set for your power supply.
- Check that the sealing strip (seen white here for clarity) is fully in its channel on the face of the module.
- Attach the module's earth link wire. Replace and tighten its screw to 2Nm.
- Push home the female (upper) and male 25-way D-connectors on to their counterparts on the rear of the drive.
- Hold the module in place, taking care not to disturb the seal or pinch the earth link wire or D-connector ribbon cables, and screw in the six retaining screws (top centre screw first). Tighten to 2.5Nm.

Note: Ensure that the 520N module is properly fitted at all times using all six screws. Without the module and the screws, the screw holes may corrode and IP66 (NEMA4X) protection will be compromised.

21.2 Wiring up

It is the user's responsibility to ensure the pump's safe and reliable operation under remote and automatic control.

The 0V lines on this pump are commoned and mains transformer-isolated from ground (floating ground). It can be connected to isolated 0V or grounded 0V interfaces.

Cable entry to the module is via up to four watertight cable glands. These may be fitted in place of the sealing plugs which are fitted to the back of the module when the pump is shipped.

The number of glands needed depends on the number of connection cables required and the convenience of the installer. As standard, four M16 cable glands are provided with the pump.



Recommended control cable conductors for the terminal blocks: metric = 0.14sq mm - 2.5sq mm solid and 0.14sq mm - 1.5sq mm stranded. USA = 26AWG - 14AWG solid and 26AWG - 16AWG stranded. Cable: circular. Max/min outside diameter to ensure a seal when passed through the standard gland: 9.5mm-5mm. **The cable section must be circular to ensure a seal.**

For EMC protection, shielded control cable should be used. The shielding should be terminated to one of the pcb mounting screws or to the adjacent spade connector (where fitted).

For improved EMC protection in extremely noisy environments, shielded cable may be used in conjunction with watertight metal EMC cable glands. These must be earthed to the module by adding an M16x1.5 nut with serrated edges to ensure proper contact with the inside of the module. It is necessary to remove the module's circuit board to access the interior of the module: it is held in place by two fixing screws which can be removed and replaced with a cross-point screwdriver. Take normal anti-static precautions when handling printed circuit boards.

Suitable cables for general-purpose use: 300V with extra premium grade PVC jacket with good flame and moisture resistance.

Suitable cables for industrial use: 300V extra-rugged polyurethane grade jacket with resistance to oils, fuels, solvents and water.

For convenience of wiring more than 8 conductors per cable may be awkward to handle. Only two appear in the illustrations here, for clarity.

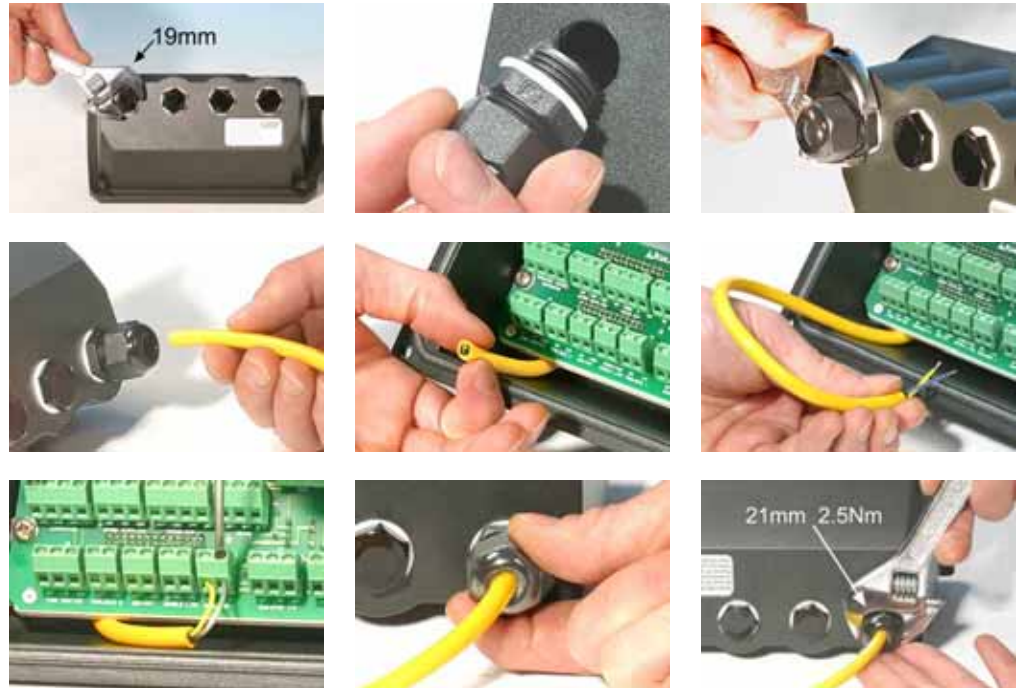



- Use a 19mm spanner to unscrew the sealing plug. Discard the nylon sealing washer.
- Screw in one of the supplied M16x1.5 cable glands in place of the plug, using the new nylon sealing washer supplied. Tighten the gland to 2.5Nm to ensure a seal, using a 21mm spanner. If a different gland is used, it must be watertight to IP66.
- Loosen the gland cap (do not remove it) and pass the cable in through the gland. When it has passed through the gland, continue to push the cable through.
- The inside of the module is shaped to guide the cable past the printed circuit board inside. Continued pushing will feed in enough cable to grip inside the module with the fingers.
- Pull through sufficient cable to reach the connectors required. Leave a little slack.

- Strip the outer sheath as necessary and remove 5mm of insulation from the conductors. No tinning or ferrule is required. **Note:** If very stiff or large-diameter cable is used, it may be convenient to strip the outer sheath before passing the cable's conductors through the gland. However, to ensure a seal, cable with an undamaged sheath must be present within the gland when it is tightened.
- Twist a suitable length of the cable screen. Loosen one of the pcb retaining screws and wrap the screen round it. Refasten the screw. Alternatively, secure the cable screen to the adjacent spade connector (where fitted).
- Push the bared conductor into the square hole in the connector. When the conductor is fully in, tighten the retaining screw to hold it in place.
- When all conductors are in position, use a 21mm spanner to tighten the gland cap to 2.5Nm to ensure a seal. Alternatively, tighten the gland by hand until it is finger-tight and use a spanner to tighten it further by one-half a turn.

Note: Do not strap the control and mains power cables together.

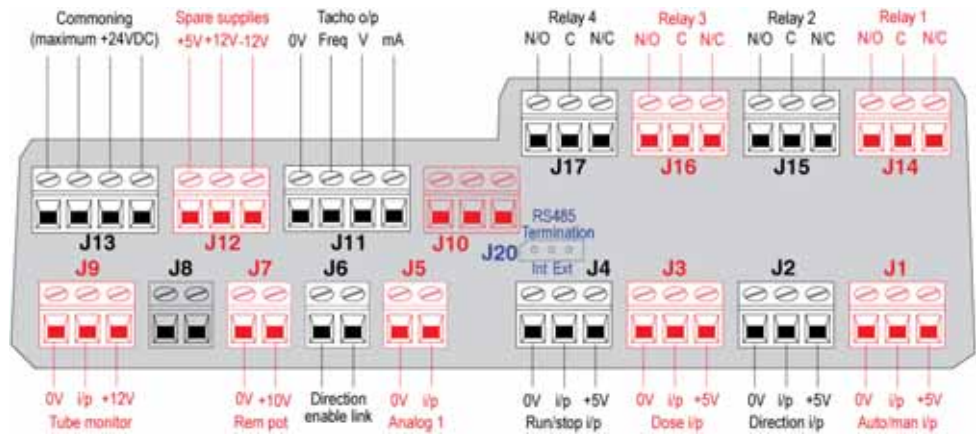
520N watertight module pcb connectors:



 **Never apply mains power to the terminals within the 520N module. Apply the correct signals to the terminals shown below. Limit signals to the maximum values shown. Do not apply voltage across other terminals. Permanent damage, not covered by warranty, may result. The maximum rating on the relay contacts of this pump is 30V DC; maximum load 30W. Note: Also suitable for low power: ie, 1mA at 5VDC minimum.**

21.3 Speed: analogue input

It is possible to control the speed of the pump remotely by one of these methods: a voltage analogue signal within the range 0-10V; or a current analogue signal within the range 4-20mA; or a remote potentiometer using the **10V** supply at J7.

The analogue process signal must be applied to the **i/p** terminal of the Analogue 1 connector (J5). Ground to the **0V** terminal of the same connector. The pump will provide an increasing flow rate for a rising control signal (non-inverted response) or an increasing flow rate for a falling control signal (inverted response). See 16.2 *Analogue* in the Setup menu.

4-20mA circuit impedance: 250Ω

For voltage mode, 0-10V, a stable, reliable voltage source can be used with a DC voltmeter. Circuit impedance: 22kΩ

Inverting the response is set up in software. Do not invert the polarity of the terminals.

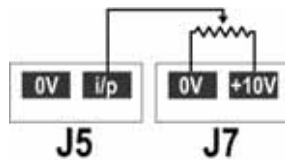

A remote potentiometer with a nominal value of between 1k and 2k with a minimum of 0.25W should be wired between the terminals of the Rem-pot connector (J7) and the **i/p** terminal of the Analogue 1 connector (J5). When using a remote potentiometer, do not apply a voltage or current control input signal at the same time. The speed control signal will require calibration relative to the minimum and maximum settings of the potentiometer. This is done in software - see 16.1 *Trim* in the Setup section.

When using a remote potentiometer, it is important to set the analogue input to voltage in the Setup menu. Otherwise the reference voltage supply from the Rem-pot connector will be overloaded and will not provide a full 10V.

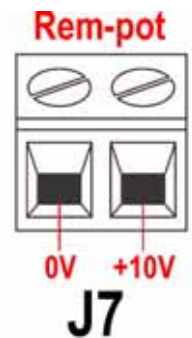
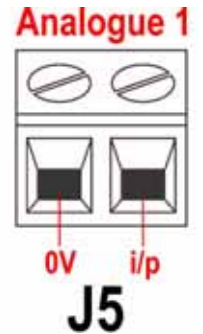

21.4 Speed: analogue output

An analogue output signal is available on the Tacho output connector (J11), between the **V** terminal and the **0V** terminal. The voltage is directly proportional to the pumphead rotation speed. 0V = zero speed; 10V = maximum allowed speed.

There is no mA output on this terminal for the 520U model. This is available on the 520Du.

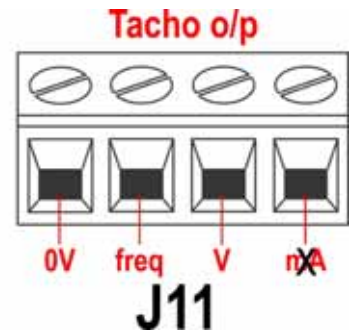

21.5 Tachometer frequency output

A tachometer frequency output is available on the Tacho output connector (J11), between the **freq** terminal and the **0V** terminal. It provides a +5V square wave pulse, maximum 0.5mA, the frequency of which is directly proportional to pumphead rotation speed. It provides 5.717 Hz/rpm - 343 pulses per output shaft revolution. The pulse train from the pump can be used to calculate the speed of rotation or to determine the number of pumphead revolutions. This output has the required strength to be effective up to 3m from the pump. Longer cable runs require signal amplification.

Important: general instructions for remote control inputs

All remote control inputs can be wired in two ways:

Logic

A logic voltage between 5V TTL and 24V industrial logic may be wired to the input. The pump is configured to operate without modification anywhere in this range. Any of the 0V terminals - though preferably the 0V terminal associated with the desired input - is connected to the control device's 0V to make the circuit. Low is equivalent to 0V. High is equivalent to 5V→24V.

Switch

A remote switch may be connected between the input and any positive voltage supply from the pump - though preferably the associated supply terminal. Do not use the 10V supply from the Rem-pot connector, however.

21.6 Run / stop input

Remote run / stop: connect a remote switch between the **i/p** terminal and the **+5V** terminal of the Run/stop i/p connector (J4). Alternatively a logic input may be applied to the **i/p** terminal, ground to the **0V** terminal. High input stops the pump, low input runs the pump. With no connection or with the switch open, the pump will default to running. To change or set the sense of the run / stop input, see 16.5 *Remote stop* in the Setup menu.

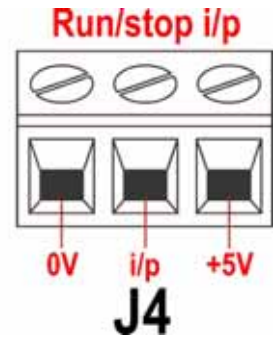

21.7 Direction input

To enable remote direction control and disable the **DIRECTION** key on the keypad, link the terminals of the Direction enable link connector (J6). **Important: Apply no voltage whatever to the Direction enable link** (J6). Connect a remote switch between the **+5V** terminal and the **i/p** terminal of the Direction i/p connector (J2). Open switch for clockwise rotation, closed switch for counter-clockwise rotation. Alternatively a logic signal may be applied to the **i/p** terminal and the **0V** terminal of the Direction i/p connector (J2). Low input for clockwise rotation, high input for counter-clockwise rotation. With no connection the pump defaults to clockwise rotation.

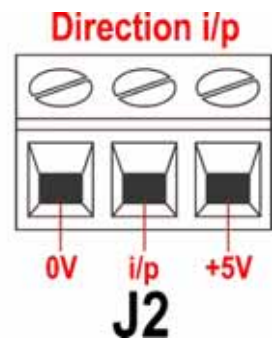
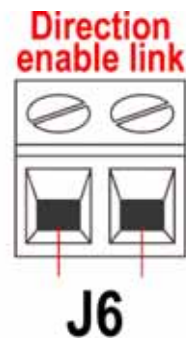

21.8 Auto / manual toggle input

Connect a remote switch between the **+5V** terminal and the **i/p** terminal of the Auto-man i/p connector (J1). Closed switch for automatic control; open switch for manual control. Alternatively a logic input may be applied to the **i/p** terminal of the Aut-man i/p connector, ground to the **0V** terminal. High input for automatic control; low input for manual control.

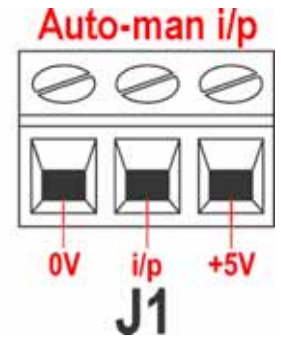

21.9 MemoDose input

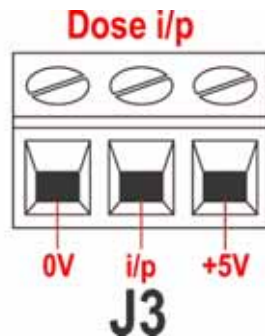

Connect a momentary contact switch such as a footswitch or a handswitch between the **5V** terminal and the **i/p** terminal of the Dose i/p connector (J3). Close the switch to begin a dose. This input is software-debounced and functions in a similar way to the other remote inputs, such as with 5V to 24V logic as shown above, using the **i/p** terminal and the **0V** terminal. **Note:** This input is software-debounced, so the signal can be either momentary or maintained during the dose. If maintained, the signal must be removed before the next dose.

21.10 Leak detection input

Connect a remote leak-detection device between the **+12V** terminal and the **i/p** terminal on the Tube monitor connector (J9). Closed circuit indicates a leak. Alternatively a logic input may be applied to the **i/p** terminal, ground to the **0V** terminal. High input indicates a leak. Connect the cable of a Watson-Marlow Tube monitor leak detector as follows:

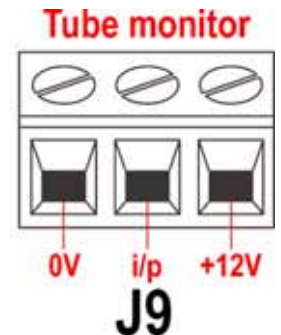

Tube monitor wire colour	520N module
Blue	J9 0V terminal
Yellow	J9 i/p terminal
Red	J9 +12V terminal
Terminate the screen in the 520N module with a 360° EMC gland if required. See 21.2 Wiring up.	

Note: Use only Watson-Marlow 520 series tube monitors.

Important: pump status outputs

Outputs 1-4 are available as single-pole change-over relay contacts: Relay 1, 2, 3 and 4. Connect to the normally open or normally closed contacts of the relay as required and configure the pump's software accordingly. See 16.4 *Outputs*.

Note: The maximum rating on the relay contacts of this pump is 30V DC; maximum load 30W.

Note: Also suitable for low power: ie, 1mA at 5VDC minimum.

21.11 Outputs 1, 2, 3, 4

Note: Relay 1 (J14) is represented here. Relay 2, Relay 3 and Relay 4 (J15, J16 and J17) function identically.

Connect your output device to the **c** (common) terminal of your chosen relay connector and either the **n/c** terminal or the **n/o** terminal (normally closed or normally open) as required. Configure the pump's software accordingly. See 16.4 *Outputs*.

By default, Relay 1 is configured to indicate Run/Stop status; Relay 2 is configured to indicate Direction status; Relay 3 is configured to indicate Auto/man status; Relay 4 is configured to indicate General alarm status. See 12 *Switching the pump on for the first time*.

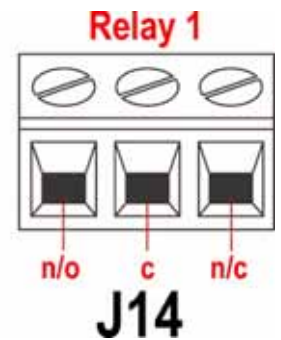

21.12 Supply voltages

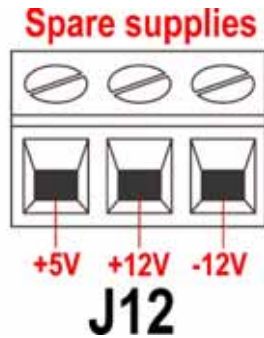

An appropriate voltage supply is available where required on each connector. In addition, supplies may be drawn from the Spare supplies connector (J12).

DC Voltage	Max load	Typical use
+5V	10mA	Voltage supply for inputs using remote switch. Possible voltage supply for outputs if only 5V is required.
+12V	10mA	Possible voltage supply for inputs using remote switch. Possible voltage supply for outputs. Voltage supply for Watson-Marlow Tube Monitor leak detector. Part voltage supply (-12V also needed) for the Watson-Marlow proximity switch.
-12V	10mA	Part voltage supply (+12V also needed) for the Watson-Marlow proximity switch.
+10V (from J7)		Reference voltage for remote potentiometer speed control. Do not use as a general supply voltage.

Note: All DC supplies are stabilised.

22 Automatic control and operation

Check that the pump is ready to run before selecting automatic operation. Remote control signals may start the pump without warning.

How to get into auto operation

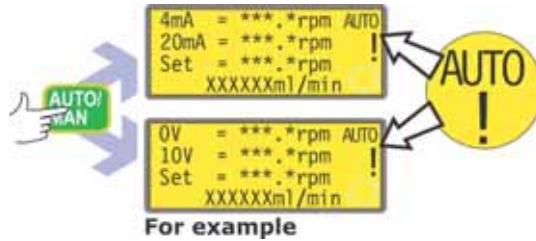

- Press the **AUTO/MAN** key to select automatic operation, or apply a high signal (5V to 24V) to the remote auto / manual input.
- The pump responds to the analogue signal as soon as this is done and shows the "AUTO" icon. The pump is automatically switched into auto-restart mode and displays the ! icon. The only keys active are **STOP**, **AUTO/MAN** and **DIRECTION**.
- If the remote direction input is active and the direction-enable link is applied, the **DIRECTION** key is disabled. If keypad lock is set, only **STOP** is active.
- The pump displays whichever of two auto running screens is appropriate according to the previously selected auto mode - 4-20mA or 0-10V.
- The auto running screens display four pieces of information: the speed at which the pump will rotate after receiving a low signal (4mA or 0V); the speed at which the pump will rotate after receiving a high signal (20mA or 10V); the set speed: the speed at which the pump is currently rotating according to the analogue signal; and the flowrate in millilitres per minute.
- The pump also responds to remote digital inputs. If the run / stop input stops the pump, the bottom line of the auto running screen shows "Remote stop". When it starts the pump again, this will disappear and the pump returns to normal running mode.
- Direction can be changed remotely.
- If the pump is stopped because a leak is detected, the screen displays "LEAK DETECTED. Check and reset, then press Stop". See 23.1 *Error codes*.
- The remote status outputs operate fully.

How to get out of auto operation

- Press the **AUTO/MAN** key or make the remote auto / manual input go low (0V). The pump returns to manual operation and retains the set speed and run status from its previous operation in analogue mode.

Emergency stop

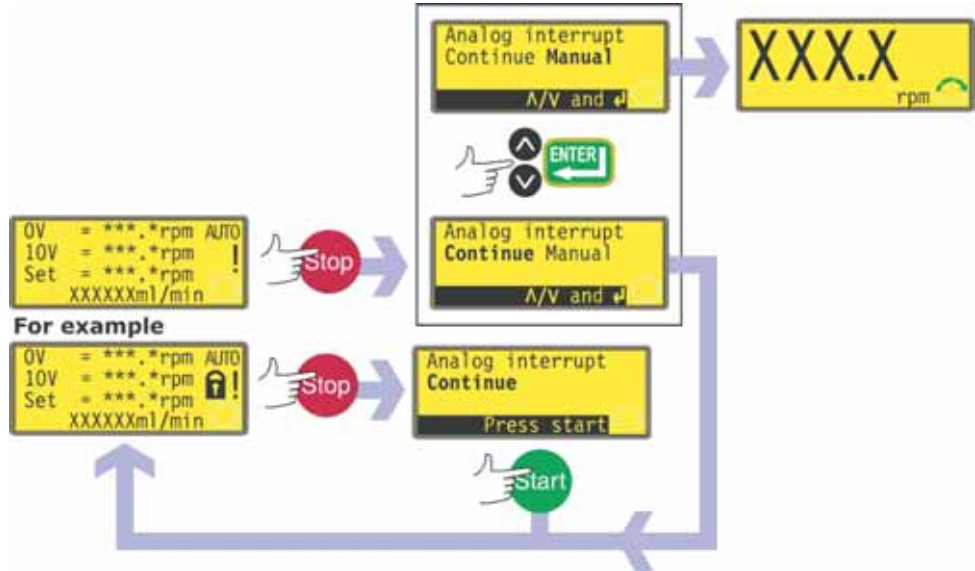

- In an emergency press the **STOP** key. The pump stops and displays an interruption screen.
- If keypad lock is in place when **STOP** is pressed, or if the pump is in auto mode via the digital input, the interruption screen offers one key-press: press **START** to continue auto operation.
- If keypad lock was not in place when **STOP** was pressed, the interruption screen offers a choice: **Continue** to continue auto operation, or **Manual** to switch to manual mode. Use the **UP** and **DOWN** keys to choose and press **ENTER** to confirm.

23 Troubleshooting

If the pump display is blank when the pump is switched on, make the following checks:

- Check the position of the voltage selector switch. The voltage selector is mounted in the switchplate at the rear of the pump, protected from water by the IP66/NEMA 4X module. The module must be removed to allow access to the switchplate. See 21.1 *520N module removal and replacement*.
- Check the mains power switch at the rear of the pump.
- Check that mains power is available to the pump.
- Check the fuse in the fuseholder in the centre of the switchplate at the rear of the pump.
- Check the fuse in the mains power plug if one is present.

If the pump runs but there is little or no flow, make the following checks:

- Check that the tube and rotor are in the pumphead.
- Check that fluid is supplied to the pump.
- Check that the tube is not split or burst.
- Check for any kinks or blockages in the lines.
- Check that any valves in the lines are open.
- Check that the correct wall-thickness tube is being used.
- Check direction of rotation.
- Check that the rotor is not slipping on the drive shaft.

23.1 Error codes

If an internal error occurs, a flashing error screen is displayed. **Note: Signal out of range, Over signal, No signal and Leak detected** error screens report the nature of an external signal. They do not flash.

Error condition	Suggested action
RAM write error	Attempt to reset by switching power OFF / ON. Or seek support
RAM corruption	Attempt to reset by switching power OFF / ON. Or seek support
OTP ROM error / corruption	Attempt to reset by switching power OFF / ON. Or seek support
OTP ROM read error	Attempt to reset by switching power OFF / ON. Or seek support
Unknown pump type	Check the interface card and cables. Attempt to reset by switching power OFF / ON. Or seek support
Display failure	Seek support
Wrong key-press	Attempt key-press again. Attempt to reset by switching power OFF / ON
Motor stalled	Stop pump immediately. Check pumphead and tube. Power OFF/ON may reset. Or seek support
Tacho fault	Stop pump immediately. Power OFF/ON may reset. Or seek support
Speed error	Stop pump immediately. Power OFF/ON may reset. Or seek support
Over current	Stop pump immediately. Check system. Power OFF/ON may reset. Or seek support
Over voltage	Stop pump immediately. Check mains voltage selector switch. Check supply. Power OFF/ON may reset. Or seek support
Under voltage	Stop pump immediately. Check mains voltage selector switch. Check supply. ON/OFF may reset. Or seek support
Watchdog error	Attempt to reset by switching power OFF / ON. Or seek support
Over temperature	Stop pump immediately. Turn OFF. Seek support
Signal out of range	Check analogue control signal range. Trim signal as required. Or seek support
Over signal	Reduce the analogue control signal
No signal	Connect analogue control signal or return to manual control
Leak detected. Check and reset	Remove the cause of any leak. The STOP key resets
Unrecognised key-press	Attempt key-press again. Attempt to reset by switching power OFF/ON. Or seek support
Work overload	Turn OFF. Check power supply. Check pumphead and tubing. Wait 30 minutes. Power ON may reset. Or seek support
General error condition	Turn OFF. Seek support

24 Drive maintenance

There are no user serviceable parts inside the pump (except the power cable: see 10 *Connecting this product to a power supply*). The unit should be returned to Watson-Marlow or its appointed agents or distributors for service.

25 Drive spares

Replaceable main fuse, type T2,5A H 250V 20mm: FS0064	Foot: MN2507M
Module seal: MN2507M	
Module pcb: MNA2066A	Module switch cover: MN2505M
Glands: GR0056	Blanking plugs: GR0057
Blanking plug and gland sealing washer: GR0058	Snap-fit vent: MN2513B

26 The 520R, 520R2 and 520RE pumpheads

Identification of parts



520R/520R2		520REL/520REM/520REH			
1	Guard latch	5	Rotor cap	9	Pumping roller
2	Guard (520R, 520R2)	6	Tube guide roller	10	Tube clamp slider (520R, 520R2)
3	Track	7	Rotor	11	Tube clamp (520R, 520R2)
4	Clutch button cover	8	Follower roller	12	Guard with seal (520RE)
				13	Drain port (520RE)

26.1 Pumphead position, removal and replacement



Always isolate the pump from the mains power supply before opening the guard or performing any positioning, removal or maintenance activity.

The pumphead track can be fitted in one of three orientations to provide right, up or down input/output port positions, whichever is convenient. Position the pumphead so that the tube ports face up or down only where the drive is placed on the bench edge - otherwise the pump tube or the hinged guard will impact the bench. Do not position the pumphead so that the tube ports face the keypad. Doing so may result in a safety risk.

The pump can be configured for clockwise or counter-clockwise rotor rotation. Please note, however, that tube life will be greater if the rotor rotates clockwise; and that performance against pressure will be maximised if the rotor rotates counter-clockwise.

To reposition the track

- Open the pumphead guard as described under 27.1 *Opening the pumphead guard*, below.
- Remove the rotor as described under *Rotor removal*, below.



- Undo and withdraw the four track-retaining screws using a slotted screwdriver.
- Remove the track.
- Relocate the track in the desired position. Replace and tighten the track-retaining screws.
- Replace the rotor as described under *Rotor replacement* below.
- Close the guard, pushing it fully home until the latch engages.

Rotor removal

- Remove any tubing from the pumphead.



- Open the flexible rotor cap in the centre of the rotor.
- Undo and withdraw the central locating screw using a slotted screwdriver.
- Pull the rotor hub off its dogged shaft.
- Between the hub and the shaft is a split collet. If the collet is retained by the shaft, pull it off, loosening it if necessary by tapping it lightly. Avoid levering it off using a screwdriver or other tool. If the collet is retained within the hub, remove it, loosening it if necessary by reinserting the central locating screw a turn or two and tapping the screw head lightly.

Rotor replacement

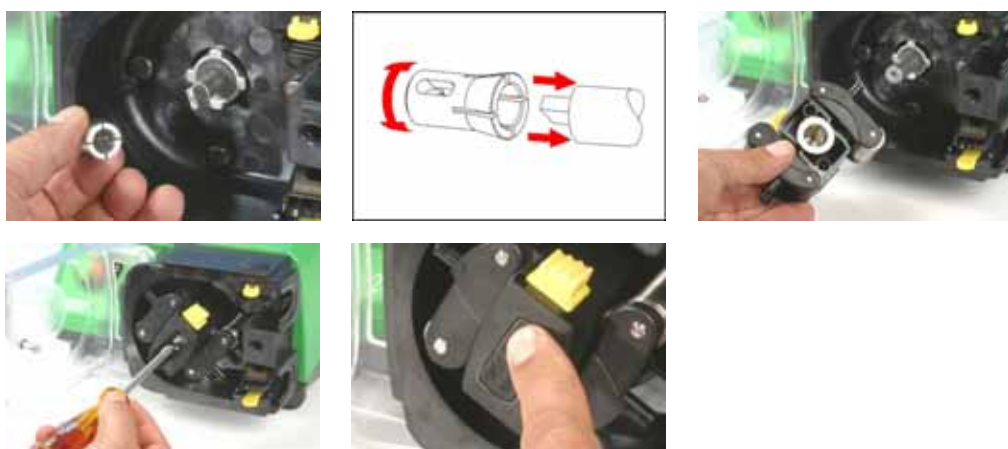

- Re-locate the split collet onto the drive shaft, rotating it until it fully engages the dog. Fit the rotor body over the drive shaft.
- Open the flexible rotor cap in the centre of the rotor. Use a slotted screwdriver to tighten the central locating screw to a torque of 3Nm (2.2 lb-ft) to prevent collet slip during operation. When fitted correctly, the tube guide rollers should align with the outer face of the track. Close the flexible rotor cap.
- Close the guard and ensure that the rotor is clear of the guard by observing the first few rotor rotations.

27 520R, 520R2 and 520RE installation



Always isolate the pump from the mains power supply before opening the guard or performing any positioning, removal or maintenance activity.

27.1 Opening the pumphead guard

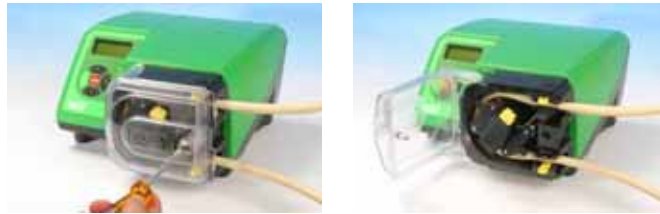

- Unlock the pumphead guard by turning the guard fastener $\frac{1}{4}$ turn anticlockwise with a slotted screwdriver.
- Open the guard to its full extent to create maximum clearance for the tube ports.
- Ensure that the rollers rotate freely and that the tube clamps are clean.

27.2 520R and 520R2 tube loading

520R continuous tubing pumpheads are factory-set to accept Watson-Marlow 1.6mm-wall tubing. 520R2 continuous tubing pumpheads are factory set to accept Watson-Marlow 2.4mm-wall tubing. Pumping performance may be adversely affected if Watson-Marlow tubing is not used.

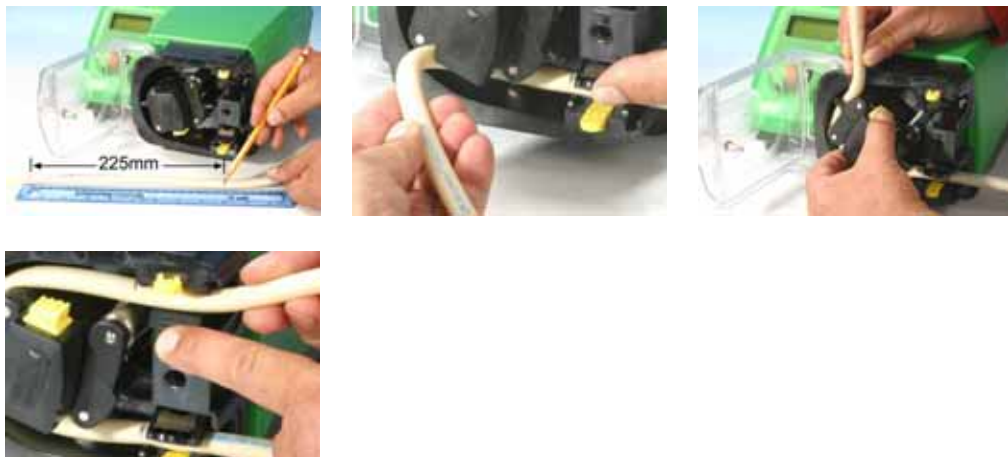

- Mark a 225mm (8 ⁷/₈ in) length onto the section of the tubing which is to be located into the pumphead. **Caution:** Placing more than 225mm (8 ⁷/₈ in) of tube inside the pumphead may result in reduced tube life.
- Open the lower spring-loaded tube clamp and locate the tubing, with the first 225mm (8 ⁷/₈ in) length mark aligned to the inside face of the spring-loaded part of the tube clamp. Release the clamp.
- Disengage the rotor clutch by fully depressing the yellow clutch button on the side of the rotor hub and turning the hub a few degrees while the clutch button is still depressed. The rotor can now rotate independently of the gearbox and motor for one full revolution. If the clutch re-engages before tube fitting is complete, depress the clutch button again and turn the rotor a few degrees.
- Feed the tubing around the pumphead track, turning the rotor as necessary. Make sure the tubing is not twisted or pinched between the guide rollers and the track. Ensure that the second 225mm (8 ⁷/₈ in) mark is adjacent to the inner edge of the upper tube clamp.
- Open the upper spring-loaded tube clamp and locate the tubing into it, making sure there is no residual twist in the tubing, and that the tube sits centrally between the tube guide rollers. Release the clamp.



- The spring-loaded tube clamps must grip the tubing tightly enough to stop it moving in and out of the pumphead but must not over-squeeze the tube and throttle fluid flow. The tubing clamps are fitted with yellow sliders which can be clicked into two positions while the clamps are held open: the outer position will allow the clamps to grip the tube tightly; the inner will grip the tube loosely. Adjust the sliders to prevent tube movement during a few trial rotations of the rotor.
- Close the guard, pushing it fully home until the latch engages.
- Connect suitable pipework to the pumphead tubing using appropriate connectors.
- Remember, when using Marprene or Bioprene tubing, re-tension the tubing after 30 minutes of running, as it may grow in length as it beds in. Re-tension so that 225mm (8 7/8 in) of tubing sits between the inside faces of the spring-loaded parts of the tube clamps.

27.3 520RE: fitting the drain port

The drain port is an optional extra, supplied with the pumphead. It is strongly recommended that users fit it before the pump is operated. It may be done with the rotor in position or removed.





- Remove the drain plug from the bottom of the pumphead. The drain plug is flexible. It may be removed using finger pressure from within the pumphead, or by accessing its flange from outside with a fingernail.
- Drop the port into position from inside the pumphead.
- Fit the supplied port retaining nut (3/8 in BSP) and finger-tighten.
- Fit drainage pipework as required (not supplied).

27.4 520RE Element loading

520RE tubing element pumpheads are factory-set to accept Watson-Marlow 2.4mm-wall tubing elements. Elements fitted with either quick-release industrial connectors or Tri-clamp sanitary connectors may be used; however, **it is vital to match the pressure rating of the element with the pressure rating of the pumphead** so that the correct roller-spring rate and occlusion settings are used. The pressure rating of the pumphead appears on the flexible rotor cap in the centre of the rotor. The pressure rating of the element appears on the connector sleeve.

Note that the rotor cap and the element connector sleeve are colour-coded.

Note: To achieve 4 bar and 7 bar pressures using a 520RE pump and the appropriate rotor and element, the pump **must** rotate counter-clockwise.

Element and rotor pressure ratings					
Colour of flexible rotor cap and element connector sleeve					
Grey		Beige		Blue	
					
520REL Pressures up to 2 bar (30 psi) Bore sizes 3.2mm, 6.4mm and 9.6mm		520REM Pressures up to 4 bar (60 psi) Bore sizes 3.2mm and 6.4mm		520REH Pressures up to 7 bar (100 psi) Bore size 3.2mm	
Industrial Marprene TL Pumpsil Neoprene Chem-Sure	Sanitary Bioprene TL Pumpsil Sta-Pure Chem-Sure	Industrial Marprene TM Chem-Sure	Sanitary Bioprene TM Sta-Pure	Industrial Marprene TH Sta-Pure	Sanitary Bioprene TH Sta-Pure

Element connectors for industrial and sanitary use	
Industrial	Sanitary
	



Check that the conical connector sleeve of the element to be fitted is the same colour as the pumphead rotor cap

520RE element loading procedure

Note: The element loading procedure is the same for industrial (pictured) and sanitary elements.



- Select an appropriate Watson-Marlow 520RE tubing element, paying attention to pressure capability, bore size, tubing material and type of connector. See the table above for pressure ratings. **Check that the connector sleeve of the element to be fitted is the same colour as the pumphead rotor cap.**
- Slide the connector D-flange at one end of the element into the lower connector D-slot.
- Disengage the rotor clutch by fully depressing the yellow clutch button on the side of the rotor hub and turning the hub a few degrees while the clutch button is still depressed. The rotor can now rotate independently of the gearbox and motor for one full revolution. If the clutch re-engages before tube fitting is complete, depress the clutch button again and turn the rotor a few degrees.
- Feed the tubing element around the pumphead track, turning the rotor as necessary. Make sure the tubing is not twisted or pinched between the guide rollers and the track.
- Slide the second connector D-flange into the upper connector D-slot.
- Check that the element lies in the middle of the track and that the connector flanges are pushed fully home.
- Close the guard, pushing it fully home until the latch engages.
- Connect suitable pipework to the pumphead tubing using appropriate connectors. See below.

27.5 520RE Element connection

Select suitable tubing to connect to the tubing element supply and discharge connectors. Check that its pressure rating is appropriate to the application.

Sanitary $\frac{3}{4}$ in mini-Tri-clamp connectors

Sanitary connectors are connected to a tubing system using mini-Tri-clamps and gaskets.



- Hold the connector end of the supply or discharge tube against the element connector, with a gasket between them.
- Use a Tri-clamp to engage both flanges squarely, close it and tighten.

Industrial quick-release connectors

Industrial connectors are connected to a tubing system using quick-release fittings.



- Hold the pump securely and push the female fitting (available from Watson-Marlow Bredel) over the element until it clicks into place.



- To disconnect, hold the pump securely and pull the connector outer sleeve and twist counter-clockwise while pulling the female connector away.

28 520R, 520R2 and 520RE maintenance



Always isolate the pump from the mains power supply before opening the guard or performing any positioning, removal or maintenance activity.

- As part of regular cleaning and maintenance (and at least every three months), lubricate the pivot points, the follower rollers and the tube guide rollers with Ultra Lube (PA 1240), which is a non-toxic perfluoroether-based grease.
- The stainless steel pumping rollers run on externally-sealed bearings and are lubricated for life.
- Check that the pumphead track, rotor, rollers and spring-loaded tube clamps are clean and operating properly.
- If fluid is spilled inside the pumphead it should be cleaned as soon as possible, as reducing exposure time to contamination will prolong pumphead service life.
- To clean the pumphead, remove the rotor as described under *Rotor removal*, above. Flush the pumphead out with water and mild detergent, or suitable cleaning agent. Clean the rotor and rollers in the same way. If specific cleaning agents are required to clean the spillage, consult the general guide to cleaning with solvents below or Watson-Marlow technical support office before proceeding, in order to confirm chemical compatibility. **Note:** the pumphead guard, rotor cap and clutch boot should be removed in advance of some cleaning regimes. See the table below. These components are available as spares if damaged.
- Replace the rotor as described under *Rotor replacement*, above.

General guide to cleaning with solvents

Chemical	Cleaning precautions
Aliphatic hydrocarbons	Remove guard. Minimize rotor cap and clutch boot exposure to less than one minute (risk of attack). Re-lubricate follower and tube guide rollers.
Aromatic hydrocarbons	Remove guard. Minimize rotor cap and clutch boot exposure to less than one minute (risk of attack). Re-lubricate follower and tube guide rollers.
Ketone solvents	Remove guard. Minimize rotor cap and clutch boot exposure to less than one minute (risk of attack). Re-lubricate follower and tube guide rollers.
Halogenated/chlorinated solvents	Not recommended: possible risk to polycarbonate tube clamp adjusters and polypropylene tube clamp locators.
Alcohols, general	No precaution necessary. Re-lubricate follower and tube guide rollers.
Glycols	Minimize rotor cap and clutch boot exposure to less than one minute (risk of attack). Re-lubricate follower and tube guide rollers.
Ester solvents	Remove guard. Minimize rotor cap and tube clamp location cap exposure to less than one minute (risk of attack). Re-lubricate follower and tube guide rollers.
Ether solvents	Not recommended: possible risk to polycarbonate tube clamp adjusters and polypropylene tube clamp locators.

29 520R, 520R2 and 520RE rotor settings

520R, 520R2 and 520RE pumpheads are factory-set to give optimum tube life with Watson-Marlow tubing and elements. Radial roller positions should not be adjusted in any circumstances as this will adversely affect pumphead performance and invalidate warranty. Tamper-proof rotor arm occlusion setting screws are fitted to warn operators from occlusion adjustment. Tubing with a wall thickness other than 1.6mm or 2.4mm can be used only with a pumphead set up for that purpose during manufacture. Contact Watson-Marlow after-sales.

30 Pumphead spares



520R/520R2		520REL/520REM/520REH	
	053.1011.100		520R
	053.1011.2L0		520R2
	053.1011.EL0		520REL
	053.1011.EM0		520REM
	053.1011.EH0		520REH
1	MNA2050A (520R, 520R2)		Pumphead guard complete with tool-unlockable latch
2	MNA2045A (520R, 520R2)		Track assembly for cased pumps complete with spring-loaded tube clamps
3	MNA2076A (520R - 1.6mm wall tube) MNA2077A (520R2 - 2.4mm wall tube) MNA2148A (grey) (520REL) MNA2149A (beige) (520REM) MNA2150A (blue) (520REH)		Rotor cover, rotor cap and clutch button
4	MN2011M S60022		Clutch Clutch spring
5	MNA2043A (520R - 1.6mm wall tube) MNA2001A (520R2 - 2.4mm wall tube) MNA2138A (520REL - 0-2 bar, 0-30 psi) MNA2139A (520REM - 2-4 bar, 30-60 psi) MNA2140A (520REH - 4-7 bar, 60-100 psi)		Rotor assembly complete with pumping rollers, follower rollers and tube guide rollers
6	MNA2006A (520R, 520R2) MN2002M (520R, 520R2) MN2131M (520RE)		Bottom (LH) tube clamp Tube clamp location plug Drain plug
7	MNA2005A (520R, 520R2) MN2002M (520R, 520R2)		Top (RH) tube clamp Tube clamp location plug
8	MN2034B MN2005M		Guard latch spring Guard latch spring cartridge
9	MNA2147A (520RE)		Pumphead guard complete with seal and tool-unlockable latch
10	MNA2144A (520RE)		Track assembly for cased pumps
11	MN2023T and MN2003T (520RE)		Drain port and nut

Parts may be ordered individually.

31 Flow rates

Pumping conditions

For precise and repeatable performance it is important to determine flow rates under operating conditions for each new piece of tubing.

When rotating counter-clockwise, 520R, 520R2 and 520RE pumpheads' flow rates are directly proportional to rotor speed. When rotating clockwise, 520R, 520R2 and 520RE pumpheads' flow rates are directly proportional to rotor speed up to 1.5 bar; their performance above 1.5 bar should be determined empirically.

Note: 520RE pumpheads should be used rotating counter-clockwise if pressures above 1.5 bar are required.

If you wish to run the pump at a speed not shown in the tables below, flow figures can be reached by dividing the maximum flow shown in the tables below by the maximum rpm figure, and multiplying the result by your required speed in rpm.

Actual flow rates achieved may vary because of changes in temperature, viscosity, inlet and discharge pressures, system configuration and tubing performance against time. Flow rates may also vary due to normal manufacturing tolerances of the tubing. These tolerances will make flow rate variance more pronounced at smaller bore sizes.

520R and 520R2

All performance figures for the 520R and 520R2 pumpheads have been recorded against peak pipeline pressures.

Although rated to 2bar (30psi) peak pressure, this pump will generate in excess of 2bar (30psi) peak pressure if the pipeline is restricted. Where it is important that 2bar (30psi) is not exceeded, pressure relief valves should be installed in the pipeline.

Viscosity handling is maximised by using 2.4mm wall tubing with the 520R2 pump-head.

Flow rates are normalised test values obtained using 225mm (8 7/8) of new tubing (measured from the inside faces of the tube clamps), and the pumphead rotating clockwise pumping water at 20C with negligible inlet and discharge pressures.

Note: Flow rates quoted are for 1.6mm and 2.4mm wall tubes. Tubes of 0.5mm and 0.8mm bore are only available in 1.6mm wall thickness except for platinum-cured silicone. Tubes of 9.6mm bore are only available in 2.4mm wall thickness.

520RE

Performance figures for the 520REL and 520REM have been recorded against 2bar peak pressure and 4bar peak pressure respectively.

Performance figures for the 520REH have been recorded against 7bar constant pressure.

Although the 520REL is rated to 2bar (30psi) peak pressure, the 520REM is rated to 4bar (60psi) peak pressure and the 520REH is rated to 7bar (100psi) constant pressure, the pumps will generate in excess of these pressures if the system pressures exceed this. Where it is important that these rated pressures are not exceeded, pressure relief valves should be installed in the pipeline.

Flow rates are normalised test values obtained using 520 elements and the pump-head rotating anticlockwise pumping water at 20C with negligible inlet and discharge pressures.

Continuous tubing

520R Neoprene, Sta-Pure, Chem-Sure, PVC, Pumpsil (ml/min)								
Speed range	0.5mm	0.8mm	1.6mm	3.2mm	4.8mm	6.4mm	8.0mm	9.6mm
520UN/R, 520UN/R2								
0.1-220rpm	0.004-9.5	0.01-24	0.04-97	0.18-390	0.40-870	0.70-1500	1.1-2400	1.6-3500

520R Marprene / Bioprene 64 shore tubing (ml/min)								
Speed range	0.5mm	0.8mm	1.6mm	3.2mm	4.8mm	6.4mm	8.0mm	9.6mm
520UN/R, 520UN/R2								
0.1-220rpm	0.004-9.0	0.01-23	0.04-92	0.17-370	0.38-830	0.67-1500	1.1-2300	1.5-3300

520R Fluorel (ml/min)					
Speed range	1.6mm	3.2mm	4.8mm	6.4mm	8.0mm
520UN/R, 520UN/R2					
0.1-220rpm	0.03-70	0.13-280	0.29-630	0.51-1100	0.80-1800

520R Neoprene, Sta-Pure, Chem-Sure, PVC, Pumpsil (USGPH)								
Speed range	0.5mm	0.8mm	1.6mm	3.2mm	4.8mm	6.4mm	8.0mm	9.6mm
520UN/R, 520UN/R2								
0.1-220rpm	0.0001-0.14	0.0002-0.35	0.001-1.4	0.003-5.6	0.006-13	0.01-22	0.02-35	0.03-50

520R Marprene / Bioprene 64 shore tubing (USGPH)								
Speed range	0.5mm	0.8mm	1.6mm	3.2mm	4.8mm	6.4mm	8.0mm	9.6mm
520UN/R, 520UN/R2								
0.1-220rpm	0.0001-0.14	0.0002-0.37	0.001-1.5	0.003-5.9	0.01-13	0.01-23	0.02-37	0.02-53

520R Fluorel (USGPH)					
Speed range	1.6mm	3.2mm	4.8mm	6.4mm	8.0mm
520UN/R, 520UN/R2					
0.1-220rpm	0.0005-1.1	0.002-4.5	0.005-10	0.01-18	0.01-28

Elements

520REL Neoprene, Sta-Pure, Chem-Sure, Pumpsil (ml/min)				520REL Marprene / Bioprene TL (ml/min)		
Speed range	3.2mm	6.4mm	9.6mm	3.2mm	6.4mm	9.6mm
520UN/REL						
0.1-220rpm	0.18-390	0.70-1500	1.6-3500	0.17-370	0.67-1500	1.5-3300

520REL Neoprene, Sta-Pure, Chem-Sure, Pumpsil (USGPH)				520REL Marprene / Bioprene TL (USGPH)		
Speed range	3.2mm	6.4mm	9.6mm	3.2mm	6.4mm	9.6mm
520UN/REL						
0.1-220rpm	0.003-6.1	0.01-25	0.03-55	0.003-5.9	0.01-23	0.02-53

520REM Sta-Pure, Chem-Sure (ml/min)			520REM Marprene / Bioprene TM (ml/min)	
Speed range	3.2mm	6.4mm	3.2mm	6.4mm
520UN/REM				
0.1-220rpm	0.18-390	0.70-1500	0.17-370	0.67-1500

520REM Sta-Pure, Chem-Sure (USGPH)			520REM Marprene / Bioprene TM (USGPH)	
Speed range	3.2mm	6.4mm	3.2mm	6.4mm
520UN/REM				
0.1-220rpm	0.003-6.1	0.01-25	0.003-5.9	0.01-23

520REH Marprene / Bioprene TH, Sta-Pure (ml/min)		520REH Marprene / Bioprene TH, Sta-Pure (USGPH)
Speed range	3.2mm	3.2mm
520UN/REH		
0.1-220rpm	0.20-450	0.003-7.1

Performance curves

Marprene continuous tubing, 1.6mm wall, 200rpm, clockwise rotation

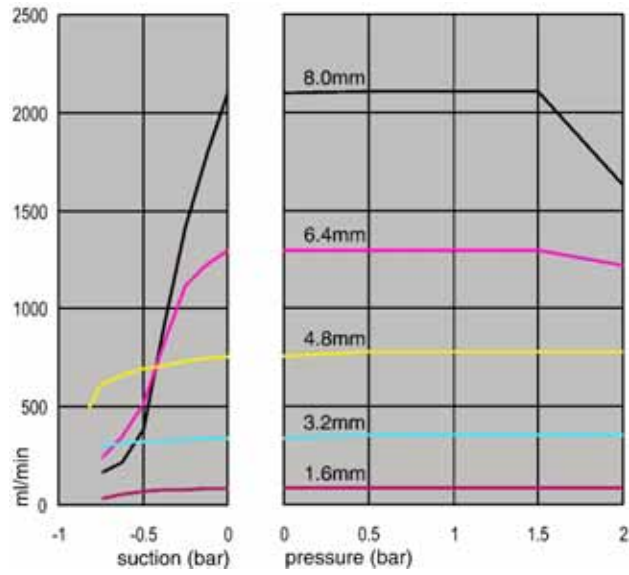

Marprene continuous tubing, 1.6mm wall, 200rpm, counter-clockwise rotation

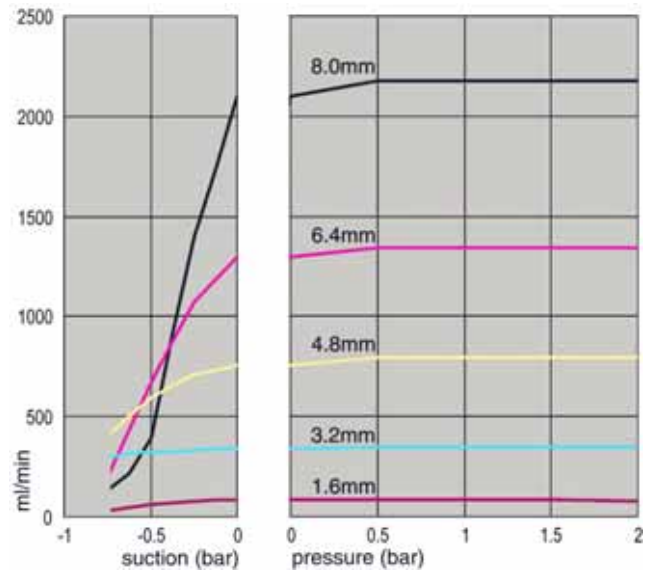

Marprene continuous tubing, 2.4mm wall, 200rpm, clockwise rotation

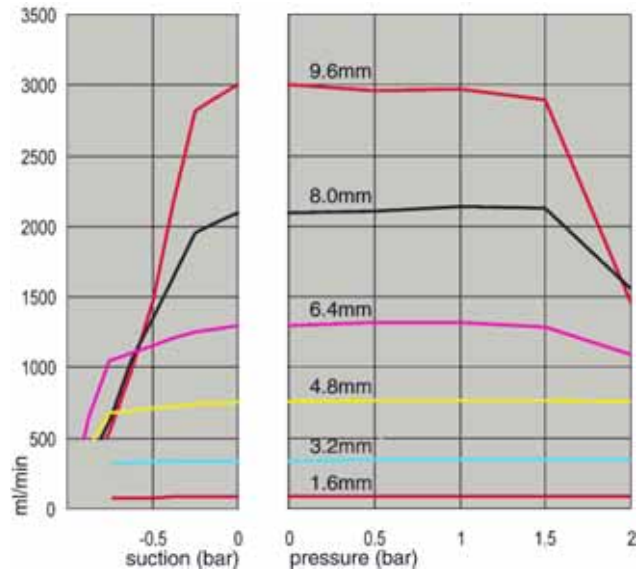

Marprene continuous tubing, 2.4mm wall, 200rpm, counter-clockwise rotation

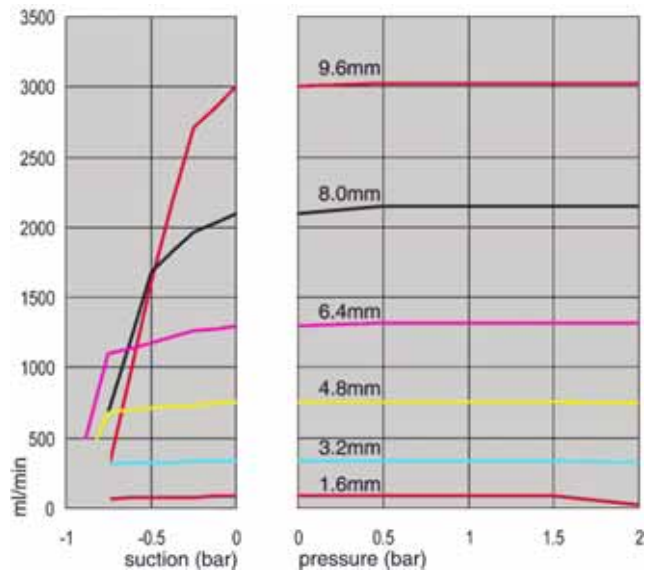

Marprene TL element, 0-2 bar (0-30psi), 200rpm, counter-clockwise rotation

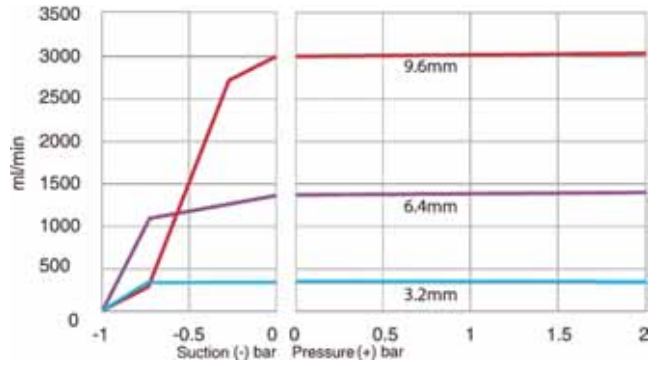

Sta-Pure element, 0-2 bar (0-30psi), 200rpm, counter-clockwise rotation

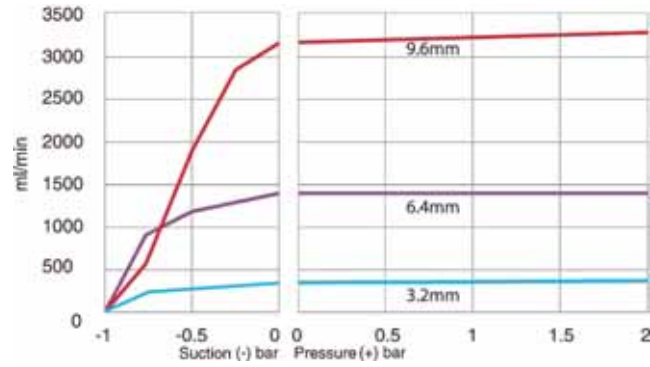

Marprene TM element, 2-4 bar (30-60psi), 200rpm, counter-clockwise rotation

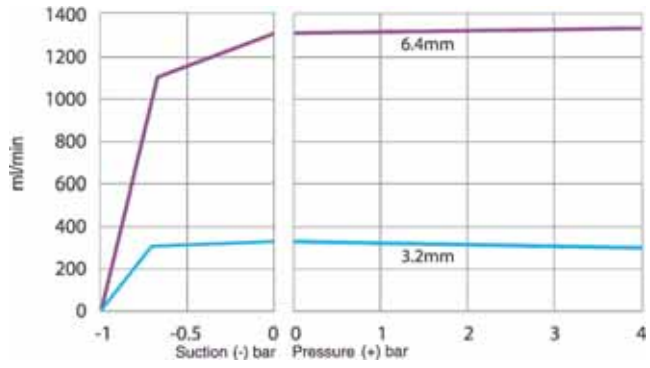

Sta-Pure element, 2-4 bar (30-60psi), 200rpm, counter-clockwise rotation

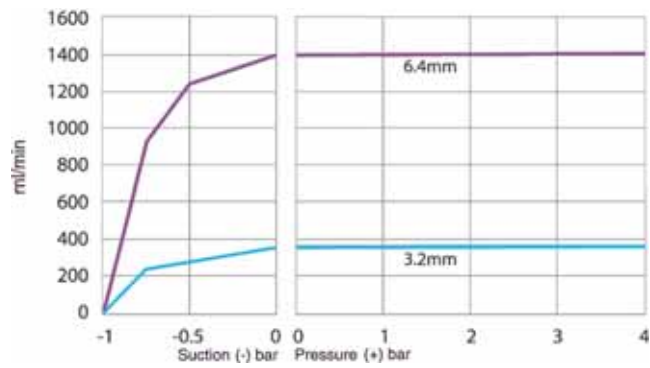

Marprene TH element, 4-7 bar (60-100psi), 200rpm, counter-clockwise rotation

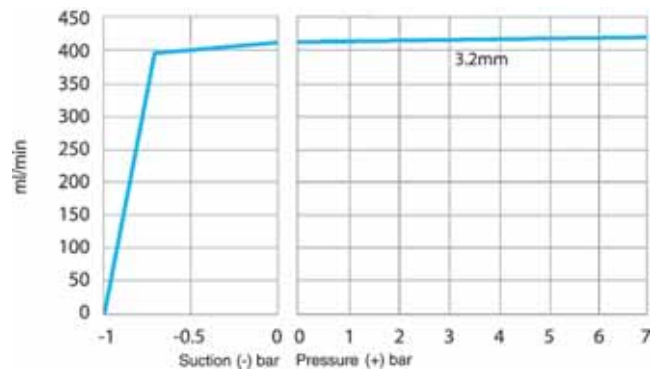



32 Tubing and element part numbers

1.6mm wall tubing for 520R pumpheads

					
mm	inch	#	Marprene	Bioprene	Chem-Sure
0.5	1/50	112	902.0005.016	903.0005.016	
0.8	1/32	13	902.0008.016	903.0008.016	
1.6	1/16	14	902.0016.016	903.0016.016	965.0016.016
3.2	1/8	16	902.0032.016	903.0032.016	965.0032.016
4.8	3/16	25	902.0048.016	903.0048.016	965.0048.016
6.4	1/4	17	902.0064.016	903.0064.016	965.0064.016
8.0	5/16	18	902.0080.016	903.0080.016	965.0080.016
mm	inch	#	PVC	Fluorel	Neoprene
0.8	1/32	13			920.0008.016
1.6	1/16	14	950.0016.016	970.0016.016	920.0016.016
3.2	1/8	16	950.0032.016	970.0032.016	920.0032.016
4.8	3/16	25	950.0048.016	970.0048.016	920.0048.016
6.4	1/4	17	950.0064.016	970.0064.016	920.0064.016
8.0	5/16	18	950.0080.016	970.0080.016	920.0080.016
mm	inch	#	Pumpsil	Sta-Pure	
0.5	1/50	112	913.A005.016		
0.8	1/32	13	913.A008.016		
1.6	1/16	14	913.A016.016	960.0016.016	
3.2	1/8	16	913.A032.016	960.0032.016	
4.8	3/16	25	913.A048.016	960.0048.016	
6.4	1/4	17	913.A064.016	960.0064.016	
8.0	5/16	18	913.A080.016	960.0080.016	

Note: 1.6mm wall Chem-Sure and Sta-Pure tubing are supplied in 305mm lengths.

2.4mm wall tubing for 520R2 pumpheads

					
mm	inch	#	Marprene	Bioprene	Pumpsil
0.5	$1/50$				913.A005.024
0.8	$1/32$				913.A008.024
1.6	$1/16$	119	902.0016.024	903.0016.024	913.A016.024
3.2	$1/8$	120	902.0032.024	903.0032.024	913.A032.024
4.8	$3/16$	15	902.0048.024	903.0048.024	913.A048.024
6.4	$1/4$	24	902.0064.024	903.0064.024	913.A064.024
8.0	$5/16$	121	902.0080.024	903.0080.024	913.A080.024
9.6	$3/8$	122	902.0096.024	903.0096.024	913.A096.024
mm	inch	#	Chem-Sure	Sta-Pure	
1.6	$1/16$	119	965.0016.024	960.0016.024	
3.2	$1/8$	120	965.0032.024	960.0032.024	
4.8	$3/16$	15	965.0048.024	960.0048.024	
6.4	$1/4$	24	965.0064.024	960.0064.024	
8.0	$5/16$	121	965.0080.024	960.0080.024	

Note: 2.4mm wall Chem-Sure and Sta-Pure tubing are supplied in 355mm lengths.

2.4mm wall elements for 520RE pumpheads

0-2 bar (0-30 psi) pressure rated elements



Industrial

mm	inch	#	Marprene TL	Pumpsil	Neoprene	Chem-Sure
3.2	1/8	16	902.0032.PFQ	913.A032.PFQ	920.0032.PFQ	965.0032.PFQ
6.4	1/4	17	902.0064.PFQ	913.A064.PFQ	920.0064.PFQ	965.0064.PFQ
9.6	3/8	122	902.0096.PFQ	913.A096.PFQ	920.0096.PFQ	965.0096.PFQ

Sanitary

mm	inch	#	Bioprene TL	Pumpsil	Sta-Pure	Chem-Sure
3.2	1/8	16	903.0032.PFT	913.A032.PFT	960.0032.PFT	965.0032.PFT
6.4	1/4	17	903.0064.PFT	913.A064.PFT	960.0064.PFT	965.0064.PFT
9.6	3/8	122	903.0096.PFT	913.A096.PFT	960.0096.PFT	965.0096.PFT

2-4 bar (30-60 psi) pressure rated elements



Industrial

mm	inch	#	Marprene TM	Chem-Sure
3.2	1/8	16	902.P032.PFQ	965.M032.PFQ
6.4	1/4	17	902.P064.PFQ	965.M064.PFQ

Sanitary

mm	inch	#	Bioprene TM	Sta-Pure
3.2	1/8	16	903.P032.PFT	960.M032.PFT
6.4	1/4	17	903.P064.PFT	960.M064.PFT

4-7 bar (60-100 psi) pressure rated elements



Industrial

mm	inch	#	Marprene TM	Sta-Pure
3.2	1/8	16	902.H032.PFQ	960.H032.PFQ

Sanitary

mm	inch	#	Bioprene TM	Sta-Pure
3.2	1/8	16	903.H032.PFT	960.H032.PFT

33 520 series pumping accessories

Accessory	Description	Part code	Pump compatibility
520ANC	Network cable, RS232, with 9-pin D-connectors	059.3121.000	520Du, 520Di
520ANX	Network extension cable with 9-pin D-connectors	059.3122.000	520Du, 520Di
520ANA	Network adaptor, 25-pin to 9-pin D-connectors	059.3123.000	
520AB	Batch records cable with 9-pin D-connectors	059.3125.000	520Di
520AF	Footswitch with 25-pin D-connector	059.3002.000	520U, 520Du, 520Di
520AH	Handswitch with 25-pin D-connector	059.3022.000	520U, 520Du, 520Di
520AV	Proximity switch	059.5072.000	520Di
520AVN	Proximity switch	059.507N.000	520DiN
505LTC	Tube clamp set for 505L pumphead	059.4001.000	520Di
505AS	Filling stand	059.5001.000	All models
520AL	Dispensing lance for use with 520AFN filling needles	059.5052.000	All models
505AFN	Filling needle set	059.5101.000	All models
	Filling needle 1.6mm bore	059.5100.016	All models
	Filling needle 3.2mm bore	059.5100.032	All models
	Filling needle 4.8mm bore	059.5100.048	All models
	Filling needle 6.4mm bore	059.5100.064	All models
	Filling needle 8.0mm bore	059.5100.080	All models
	Tube monitor with 25-pin D-connector	059.4501.520	520U, 520Du, 520Di
	Tube monitor, bare lead	059.450N.520	520UN, 520DuN, 520DiN
520AD	Leak detector kit	059.8121.000	520U, 520Du, 520Di
520AD	Leak detector kit	059.8131.000	520UN, 520DuN, 520DiN

34 Trademarks

Watson-Marlow, Bioprene, Pumpsil, LoadSure and **Marprene** are trademarks of Watson-Marlow Limited.

Fluorel is a trademark of 3M.

Sta-Pure and **Chem-Sure** are trademarks of W.L.Gore and Associates.

35 Warning not to use pumps in patient-connected applications

Warning These products are not designed for use in, and should not be used for patient-connected applications.

36 Publication history

m-520un-ip66-gb-05.qxp: Watson-Marlow 520UN IP66 NEMA 4X

First published 12 03. Revised 09 06. Revised 01 08.

37 Decontamination certificate

In compliance with the *UK Health and Safety at Work Act* and the *Control of Substances Hazardous to Health Regulations*, you are required to declare the substances which have been in contact with product(s) you return to Watson-Marlow or its subsidiaries or distributors. Failure to do so will cause delays. Please ensure that you fax us this form and receive an RGA (Returned Goods Authorisation) before you despatch the product(s). A copy of this form must be attached to the outside of the packaging containing the product(s). Please complete a separate decontamination certificate for each product.

You are responsible for cleaning and decontaminating the product(s) before return.

Your name	<input type="text"/>	Company	<input type="text"/>
Address	<input type="text"/>		
Postcode/zip	<input type="text"/>	Country	<input type="text"/>
Telephone	<input type="text"/>	Fax	<input type="text"/>
Product type	<input type="text"/>	Serial number	<input type="text"/>
To speed the repair, please describe all known faults	<input type="text"/>		
The product has ...	<input type="checkbox"/> Been used <input type="checkbox"/> Not been used		
	<i>If the product has been used, please complete all the following sections. If the product has not been used, please just sign this form.</i>		
Names of chemicals handled with product(s)	<input type="text"/>		
Precautions to be taken in handling these chemicals	<input type="text"/>		
Action to be taken in the event of human contact	<input type="text"/>		
	<i>I understand that the personal data collected will be kept confidentially in accordance with the UK Data Protection Act 1998.</i>		
Signature	<input type="text"/>	RGA number	<input type="text"/>
		Your position	<input type="text"/>
		Date	<input type="text"/>
<i>Please print out, sign and fax to Watson-Marlow Pumps at +44 1326 376009.</i>			