



Universal oven
UNE 200-800
UFE 400-800







Steriliser
SNE 200-400
SFE 400-800

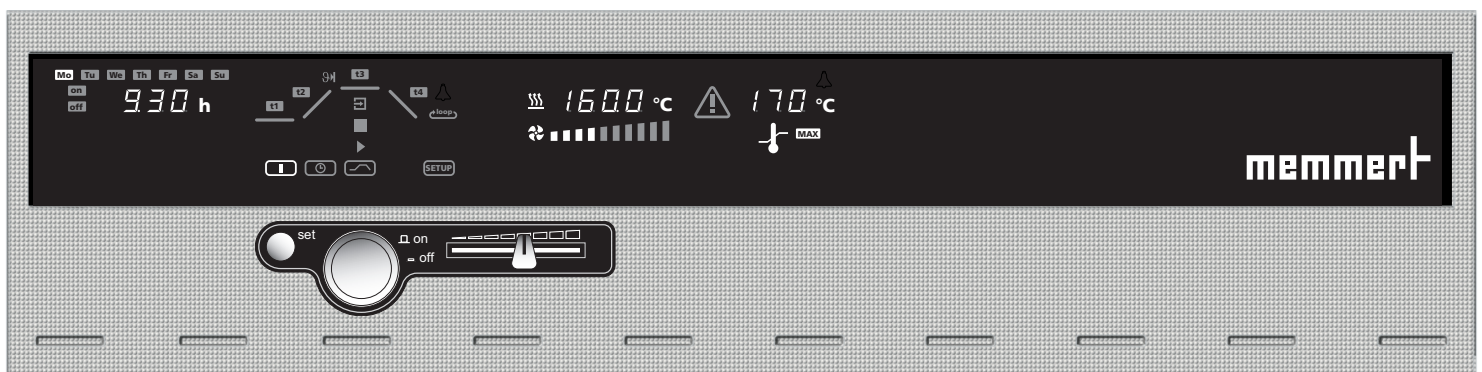

Incubator
INE 200-800

Operating Instructions



| | | |
|------|---|----|
| 1. | Contents | 2 |
| 2. | General notes and safety notes | 4 |
| 2.1 | Intended purpose when used as medical product | 4 |
| 2.2 | Transport | 4 |
| 2.3 | Initial start-up | 5 |
| 2.4 | Oven load | 5 |
| 3. | Technical data | 6 |
| 3.1 | Standard equipment of EXCELLENT ovens | 7 |
| 3.2 | Material quality | 7 |
| 3.3 | Electrical equipment | 8 |
| 3.4 | External connection | 8 |
| 4. | Installation facilities (accessories) | 9 |
| 4.1 | Subframe | 9 |
| 4.2 | Wall bracket | 9 |
| 4.3 | Stackable version | 9 |
| 5. | Oven construction and operation | 10 |
| 5.1 | Operating the door | 10 |
| 5.2 | Controls and indications | 11 |
| 5.3 | Switching on | 11 |
| 5.4 | Setting air changes | 11 |
| 5.5 | Setting the temperature | 11 |
| 6. | Selecting the operating mode | 12 |
| 7. | Setting the parameters | 12 |
| 8. | Normal operation  | 13 |
| 9. | Weekly programmer  | 15 |
| 10. | Ramp timer  | 17 |
| 11. | Basic oven settings  | 23 |
| 11.1 | Real-time clock | 23 |
| 12. | Temperature monitor and protection devices | 24 |
| 12.1 | Mechanical temperature monitor: temperature limiter (TB) | 24 |
| 12.2 | Electronic temperature monitor | 24 |
| 13. | Calibration | 26 |
| 14. | Communication interface RS232C for the PC | 28 |
| 15. | Report memory | 29 |
| 15.1 | Reading the report memory into the PC via RS232C | 29 |
| 16. | Sterilisers | 30 |
| 16.1 | Guidelines for sterilisation in MEMMERT hot air sterilisers | 30 |
| 16.2 | Steriliser cassettes | 34 |
| 17. | Cleaning | 35 |
| 18. | Maintenance | 35 |
| 19. | Error messages | 36 |
| 20. | Supply failure | 36 |
| 21. | CE Conformity Declaration | 37 |
| 22. | Address | 40 |
| 23. | Index | 41 |

2. General notes and safety notes

You have purchased a technically fully proven product which has been produced in Germany with the use of high-grade materials and the application of the latest manufacturing techniques; it has been factory tested for many hours.

In addition we guarantee the supply of spare parts over 10 years.



This mark in the Operating Instructions means:

Watch out
Important Note



This mark on the product means:

Note Operating Instructions
Warning – oven hot when operating



Observation of the Operating Instructions is necessary for faultless operation and for any possible claims under warranty. If these Instructions are disregarded, all claims under warranty, guarantee and indemnification are excluded.

The right to technical modifications is reserved.
Dimensional details are not binding.

2.1 Intended purpose when used as medical product

For ovens covered by the scope of the Directive 93/42/EEG (Directive of the Commission on the harmonization of the legal regulations of the Member States on medical devices) the following intended purpose applies:

For ovens series INE / UNE / UFE:

The product is intended for heating non-sterile cloths, sheets and blankets.

For ovens series SNE / SFE:

The product is intended for the sterilisation of medical products with dry heat using hot air at atmospheric pressure.

2.2 Transport

Always use gloves!

If the oven has to be carried, at least 2 persons are required to transport it.

2.3 Initial start-up

When the oven is started up for the first time, it should be supervised continuously until steady conditions have been reached. Severe vibrations during transport may cause movement of the temperature probes in their holder inside the chamber. Note therefore that before the first start-up the temperature probes should be checked for their correct position and, if necessary, carefully aligned in their mounting (see ill).

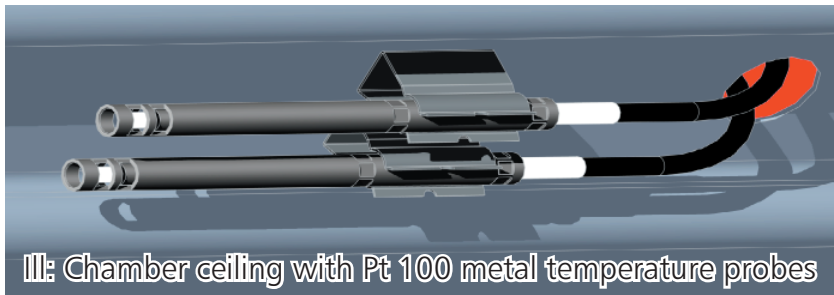

2.4 Oven load

Full consideration must be given to the physical and chemical properties of your load (e.g. combustion temperature etc.) in order to prevent serious damage to load, oven and surroundings.

Please note that the Memmert ovens described here are not explosionproof (they do not conform to the Industrial Association Specification VBG 24) and are therefore not suitable for drying, evaporating and burning-in of paints, enamels or similar materials whose solvents may produce an inflammable mixture with air. There must be no possibility of the formation of inflammable gas/air mixtures either within the oven chamber or in the immediate surroundings of the equipment.

Large amounts of dust or corrosive fumes inside the oven chamber or in the surroundings of the equipment may produce deposits within the oven and lead to short-circuits or damage the electronics. It is therefore important that adequate precautions are taken against excessive dust or corrosive fumes.

In order to ensure proper air circulation inside the chamber, there must be sufficient spacing of the load inside the oven. Do not place any load on the floor, against the side walls or underneath the ceiling of the chamber (heating ribs). In order to ensure optimum air circulation the shelves must be so inserted that the air spacings between door, shelf and rear chamber wall are approximately equal.

The maximum number and the loading of the shelves can be found in the [table in the Section "Technical Data"](#). With unfavourable loading (too closely spaced) and completely opened ventilation it is possible that the set temperature may be reached only after a longer period of time.

See stick-on label "Correct Loading" on the oven!

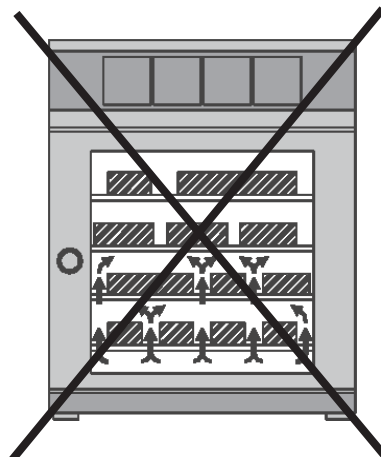
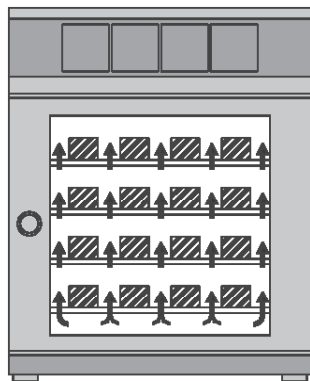

3. Technical data

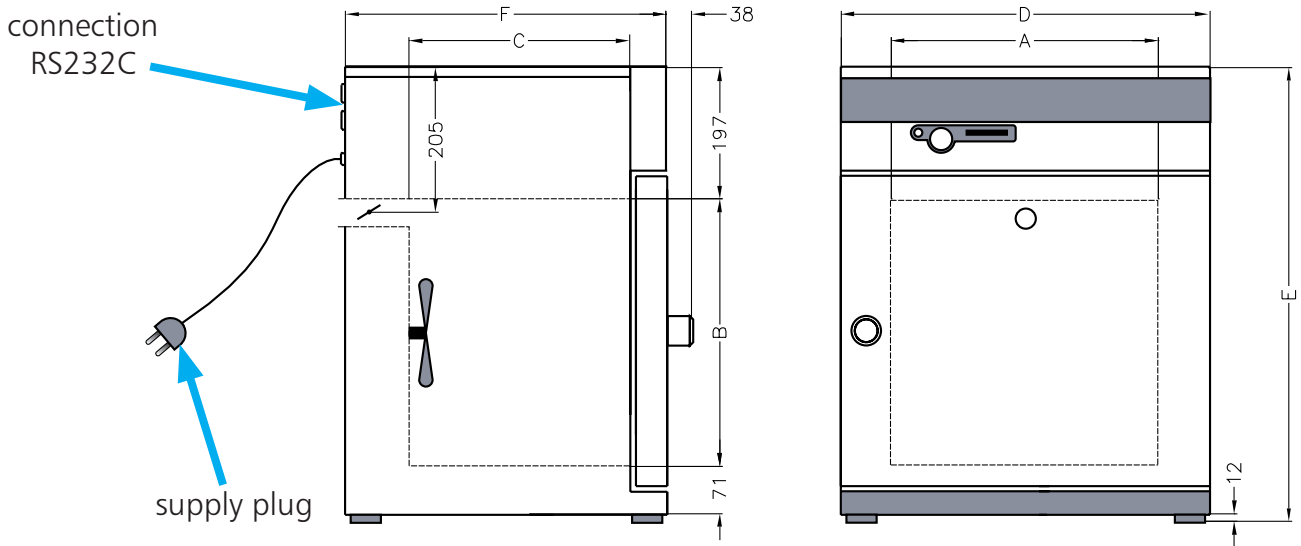

| | | | | | | | |
|----------------------------------|--|------|------|------|------|------|------|
| Model | 200 | 300 | 400 | 500 | 600 | 700 | 800 |
| Chamber width A [mm] | 400 | 480 | 400 | 560 | 800 | 1040 | 1040 |
| Chamber height B [mm] | 320 | 320 | 400 | 480 | 640 | 800 | 1200 |
| Chamber depth C [mm] | 250 | 250 | 330 | 400 | 500 | 500 | 600 |
| Oven width D [mm] | 550 | 630 | 550 | 710 | 950 | 1190 | 1190 |
| Oven height E [mm] | 600 | 600 | 680 | 760 | 920 | 1080 | 1605 |
| Oven depth F [mm] | 400 | 400 | 480 | 550 | 650 | 650 | 750 |
| Chamber volume [Liter] | 32 | 39 | 53 | 108 | 256 | 416 | 749 |
| Weight [kg] | 28 | 30 | 35 | 50 | 87 | 121 | 170 |
| Power, ovens UNE/UFE/SNE/SFE [W] | 1100 | 1200 | 1400 | 2000 | 2400 | 4000 | 4800 |
| Power, ovens INE [W] | 440 | 500 | 800 | 900 | 1600 | 1800 | 2000 |
| Max. number of shelves | 3 | 3 | 4 | 5 | 7 | 8 | 10 |
| Max. load per shelf [kg] | 15 | 12 | 30 | 30 | 30 | 30 | 30 |
| Total load per oven [kg] | 30 | 30 | 90 | 60 | 80 | 100 | 160 |
| Ambient conditions | Ambient temperature 5°C to 40°C rH 80% max., no condensation Overvoltage category: II Contamination level: 2 | | | | | | |
| Setpoint temperature range | 20°C to nominal temperature (details see label) | | | | | | |
| Setting accuracy: | INE: 0.1°C UNE/UFE/SNE/SFE: 0.5°C | | | | | | |
| Working temperature range | From 5°C above ambient temperature up to nominal temperature = maximum temperature (details see label) With fan switched on (UFE/SFE) from 10°C above ambient temperature up to nominal temperature = maximum temperature (details see label) | | | | | | |

3.1 Standard equipment of EXCELLENT ovens

- Electronic fuzzy-supported PID process controller with delayed programme start, programmable heating and cooling ramp, setpoint-dependent waiting time and repeat function . The controller has permanent power matching and an auto-diagnostic system for rapid fault finding (see Section: "Error messages")
- Internal report memory 1024kB for storing actual temperature, setpoint temperature and error states with time stamp
- Fan with speed adjustment on recirculation ovens (adjustment in 10% steps)
- Manually adjustable air valve for recirculation or fresh air operation
- Integral weekly programmer with group function (e.g. all workdays)
- Recessing push/turn control for simple operation of oven
- Visual alarm indication
- Digital overtemperature monitor (TWW Class 3.1)
- Mechanical temperature limiter (TB Class 1)
- Monitor relay to switch off heating in case of fault
- Two separate PT100 temperature sensors Class A in 4-wire circuit for control and monitoring
- Convenient 3-point temperature calibration
- Temperature-dependent ventilation of control panel and door
- Serial RS232C interface for computer-supported temperature programmes and for reading the internal report memory
- MEMMERT software "Celsius 2005" for remote operation of oven via a PC
- Special equipment (to be ordered separately as accessories): adjustable temperature limiter (TWB), subframe, wall bracket, wire shelf, sterilisation cassette, cable RS232C to DIN 12 900-1

3.2 Material quality

For external casing and working chamber MEMERT are using stainless steel (Mat.Ref. 1.4301) which features high strength, optimum hygienic properties and corrosion resistance against many (not all) chemicals (warning against e.g. chlorine compounds).

The oven load has to be checked carefully for its chemical compatibility with the above materials. A compatibility table covering all these materials can be requested from MEMMERT.



Do not place the oven on a readily inflammable support surface!



WARNING! Always pull out the supply plug
before opening the oven cover!

3.3 Electrical equipment

- Operating voltage see label 50/60 Hz
- Current rating see label
- Protection Class 1, i.e. operating isolation with ground connection to EN 61 010
- Protection IP20 to EN 60 529
- Interference suppression to EN55011 Class B
- Oven protected by a fuse 250V/15A fast blow
- Controller protected by a 100 mA fuse (200 mA on 115 V)
- When connecting a MEMMERT oven to the electrical supply you have to observe any local regulations which apply (e.g. in Germany DIN VDE 0100 with FI protection circuit)

This product is intended to operate on a supply network with a system impedance Z_{max} at the transfer point (building connection) of 0.292 Ohm max. The user has to ensure that the product is only operated on an electrical supply network which meets these requirements. If necessary, details of the system impedance can be obtained from the local electricity supply authority.

3.4 External connection

Equipment connected to the external connections must have interfaces which meet the requirements for safe low voltage (e.g. PC).

4. Installation facilities (accessories)

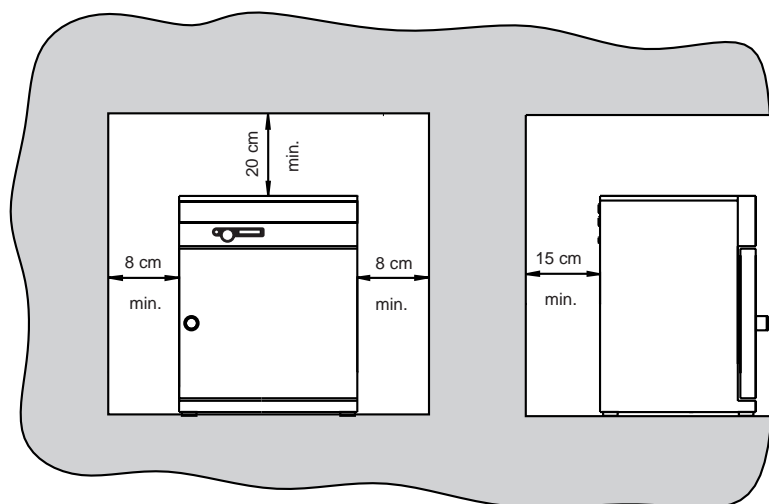

The oven can be placed on the floor or on a bench (working surface). It is important that the oven is set up accurately horizontally; the door may have to be adjusted (see [Section: "Maintenance"](#))

The spacing from the back of the oven to the wall should be at least 15 cm. The spacing to the ceiling must not be less than 20 cm and that at the side to the wall not less than 8 cm. Generally it is essential to have adequate air ventilation around the oven.

Model 800 is mounted on castors. The front castors pivot and can be locked. In order to ensure the stability of the oven the front castors must always be set facing towards the front.

Information on accessories will be found in our leaflet or on our internet page www.memmert.com.

Please note the installation instructions for our accessories.

4.1 Subframe

Oven models 500 to 700 can be mounted on a subframe (accessory)

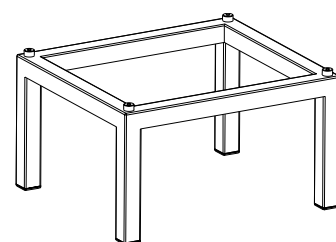

4.2 Wall bracket

Oven models 200 to 700 can be wall-mounted using the wall bracket (accessory). The wall bracket is factory-fitted with a fire-resistant plate. The size and length of the screws used and of the corresponding dowel plugs depend on the total weight (oven plus load) and vary with the condition of the wall.

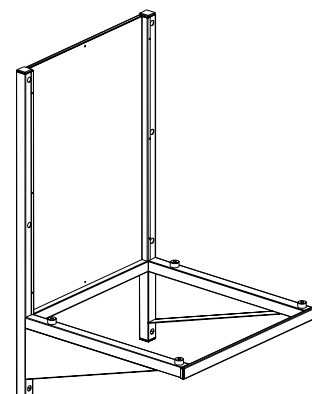

4.3 Stackable version

Two ovens of the same model size can be stacked on each other. Note that the oven with the lower working temperature must always be placed at the bottom.

Foot locators (accessory) have to be fitted on the bottom oven. (Model 700 can only be stacked using an intermediate frame.)

- Take off cover of bottom oven
- Place drill jig (supplied with foot locators) into the inverted cover at the back
- Mark holes and drill 4.2 mm dia.
- Screw the foot locators to the top of the cover using the screws and nuts supplied
- Re-fit the cover

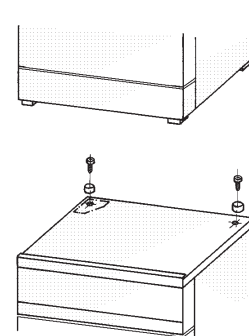

5. Oven construction and operation

Ovens Series UNE, INE and SNE have natural ventilation.

In Series UFE and SFE ovens, air circulation is provided by a fan on the back wall of the chamber.

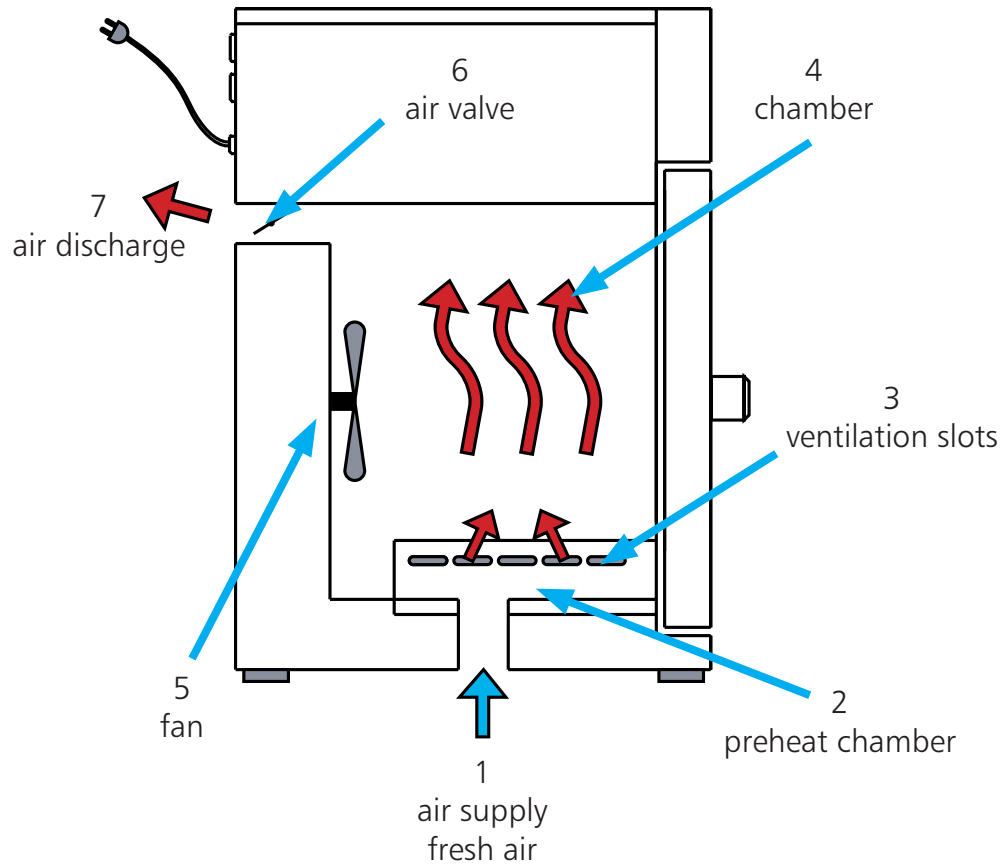

The incoming air (1) is warmed in a preheat chamber (2) in both convection and fan-circulation ovens. The preheated air enters the chamber (4) through ventilation slots (3) in the chamber side wall. The fan (5) on the chamber back wall produces a larger air throughput and a more intensive horizontal forced circulation compared with natural convection. The air valve (6) on the back of the oven controls the rate of air intake and discharge (air change) (7).

5.1 Operating the door

The door is opened by pulling on the door handle.

The door is closed by the door handle being pushed in.

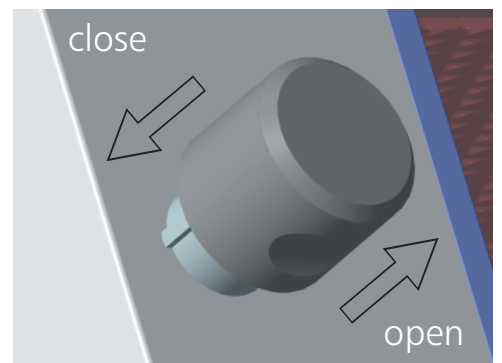

5.2 Controls and indications

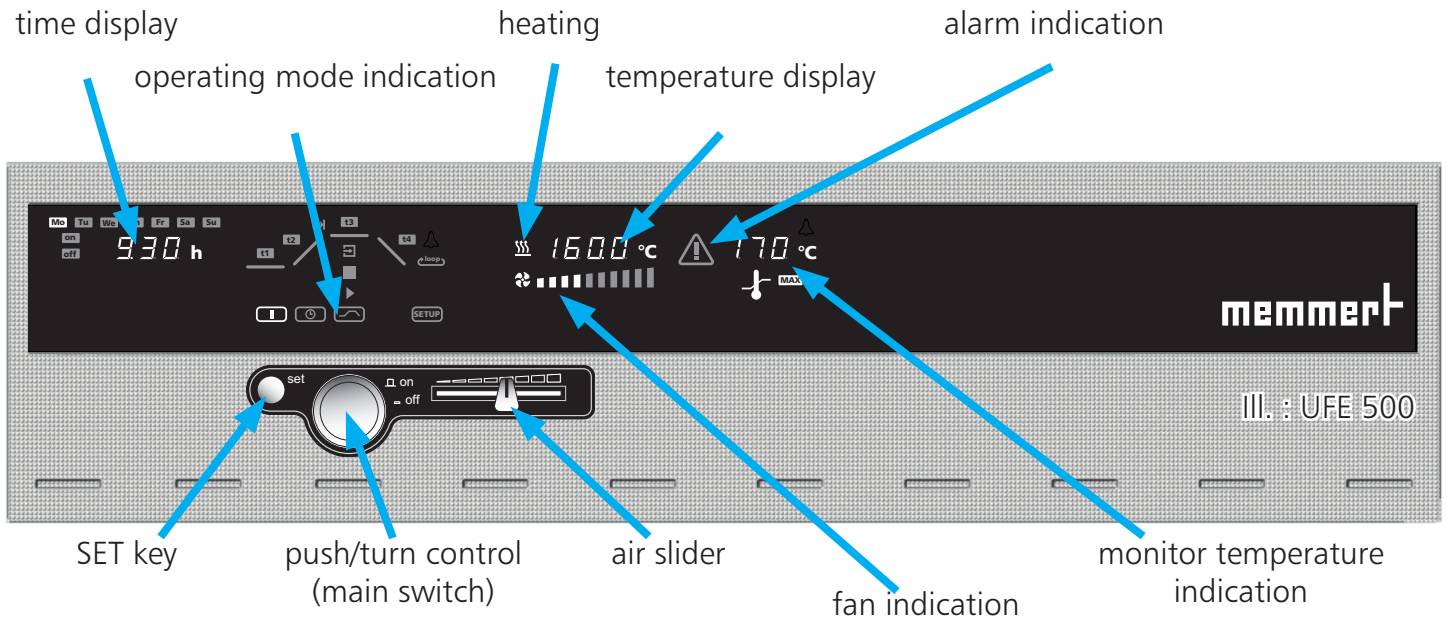

5.3 Switching on

The oven is switched on by pressing the push/turn control.

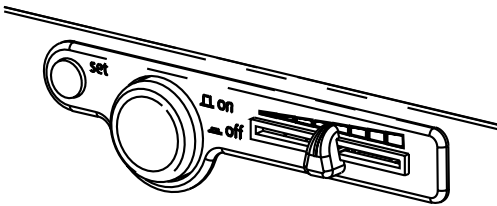

Oven switched off. The push/turn control is pushed in and protected against damage

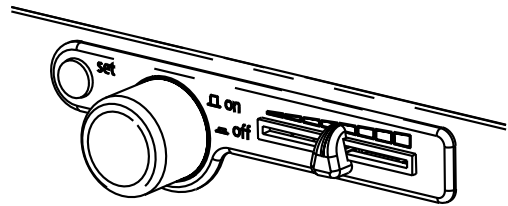

Oven switched on and can be operated using the push/turn control and the SET key.

5.4 Setting air changes

Moving the air slider opens and closes the air valve to control the supply and discharge of air.

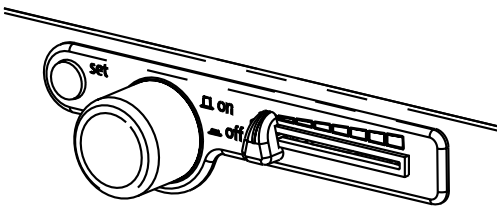

Air valve closed

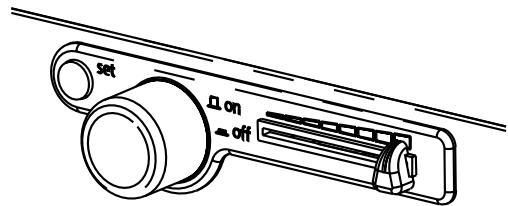

Air valve fully open

5.5 Setting the temperature

Hold down the SET key and set the temperature setpoint with the push/turn control.

After the SET key has been released the display briefly flashes the temperature setpoint. The display then changes to the actual current temperature and the controller starts to control to the selected temperature setpoint.

6. Selecting the operating mode

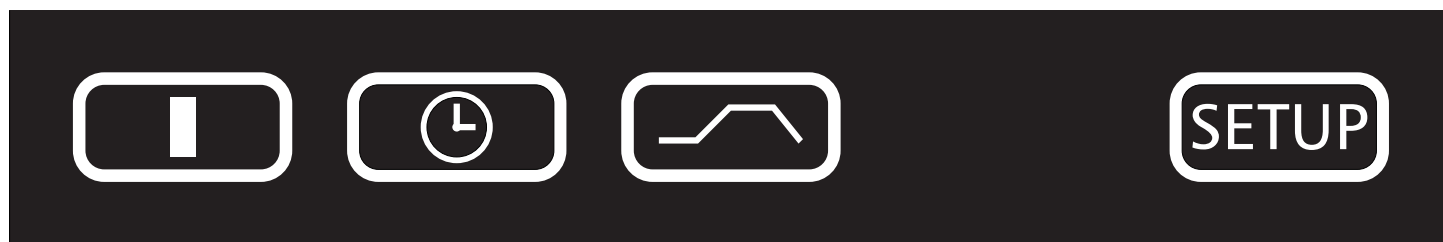

Normal operation

Weekly
programmer

Ramp timer
Programme
operation

Basic settings

After holding down the SET key (approx. 3 sec), the current operating mode flashes on the display. A different operating mode can be selected with the push/turn control while the SET key is being held down. After the SET key has been released the controller operates in the new operating mode.

7. Setting the parameters

After an operating mode has been selected, all relevant controller settings are shown simultaneously on the display.

A parameter (menu item) can be selected by rotating the push/turn control; all other parameters are then dimmed.

The selected parameter flashes brightly and can now be altered with the push/turn control while holding down the SET key.

After the SET key has been released the newly set value is stored.

If the push/turn control or the SET key have not been operated for a period of 30 seconds, the controller automatically returns to the main menu.



8. Normal operation

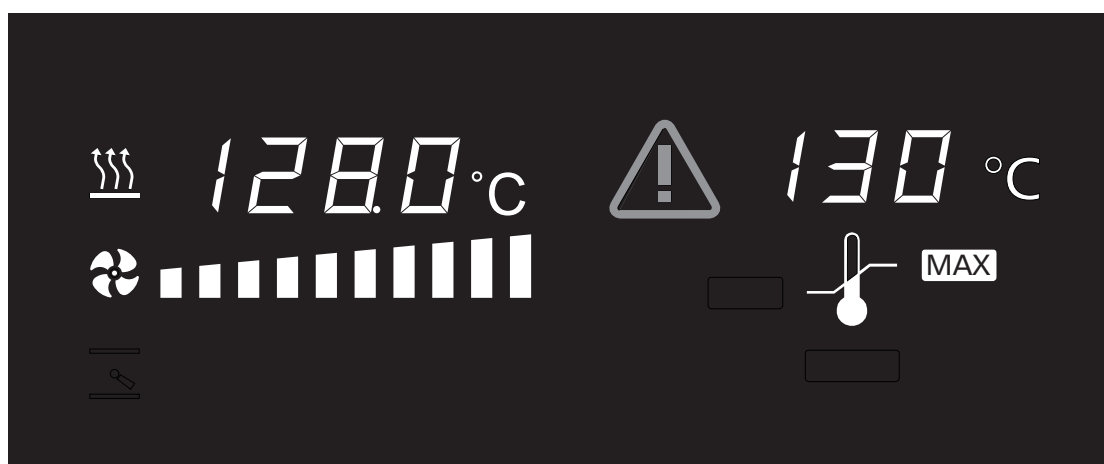

In this operating mode the oven operates continuously. The settings for operating the oven can be selected. The settings act directly on the operation of the oven.

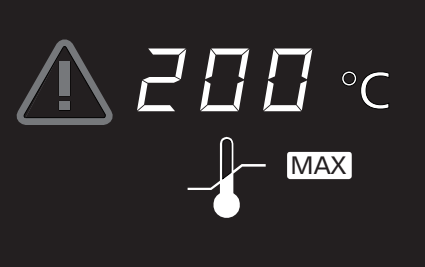

By rotating the push/turn control the following parameters can be selected and can be altered as described in the Section "Setting the parameters":

| | |
|---|---|
| <p><u>Temperature setpoint</u> Range: 20°C up to nominal temperature (details see label)</p> |  |
| <p><u>Fan speed</u> Range: 0 to 100% in 10% steps</p> |  |
| <p><u>Temperature monitor</u> Range: up to 10°C above nominal temperature (details see label). (see Section: "Temperature monitor")</p> |  |

Setting example "Normal operation"

The oven (UFE500) has to heat up to 180°C at a fan speed of 50%. The overtemperature monitor has to operate at 200°C.

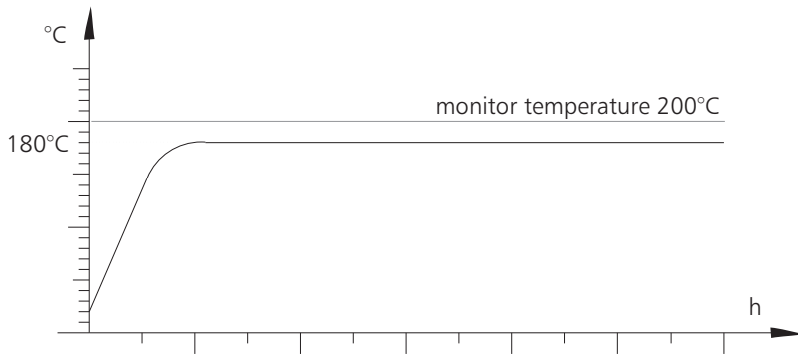

| | |
|---|--|
| <p>1. Select operating mode "Normal operation" After holding down the SET key (approx. 3 sec), the current operating mode is flashing. Select operating mode I with the push/turn control while holding down the SET key. After the SET key has been released the controller is in operating mode I.</p> | |
| <p>2. Select temperature setpoint Hold down the SET key and use the push/turn control to select the required temperature setpoint of 180°C. After the SET key has been released the oven briefly flashes the temperature setpoint. The display then changes to the actual temperature and the controller starts to control to the selected temperature setpoint of 180°C. Heating is indicated by the orange heater symbol.</p> | |
| <p>3. Select fan speed Turn the push/turn control clockwise until the fan symbol is flashing. While holding down the SET key, use the push/turn control to set 50% fan speed.</p> | |
| <p>4. Select monitor temperature Turn the push/turn control clockwise until the monitor temperature display is flashing. Hold down the SET key and use the push/turn control to set the monitor temperature to 200°C.</p> | |

9. Weekly programmer



In this operating mode the weekly programmer is activated and the oven switches on and off automatically at the programmed times.

While the weekly programmer is in the OFF phase the oven is in standby mode. Heating and fan are switched off, the controller display is dimmed and shows the clock time.





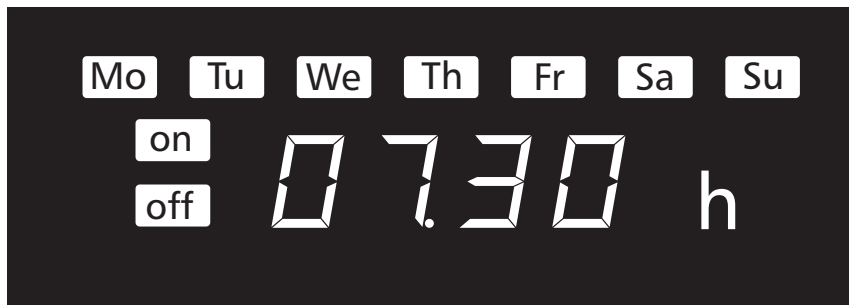

The sequence of the weekly programmer is repeated every week.

A maximum of 9 time blocks, each consisting of ON time and OFF time, can be programmed. Clockwise rotation of the push/turn control is used to select the temperature setpoint (etc.) to which the oven has to control during the ON phase. If no settings are made the controller takes the values from operating mode I.

By clockwise rotation of the push/turn control the parameters can be selected as in operating mode I, and altered as described in [Section "Setting the parameters"](#).



The time blocks are selected by rotating the push/turn control anticlockwise. The switching times can be altered while holding down the SET key.

| | |
|--|--|
| <u>Weekday</u> Range: Monday to Sunday |  |
| <u>Day groups</u> Range: workday Mo-Fr weekend Sa-Su |   |
| <u>No ON time: ----</u> On these days the oven is not switched on |  |
| <u>ON time</u> Range: 00:00 to 23:59 hrs. |  |
| <u>OFF time</u> Range: one minute above ON time to 24:00 |  |

For safety reasons, always check that an ON time has been programmed only during the required time blocks and days.

Setting example "Weekly programmer"

The oven (UFE500) has to switch on at 07.30 hrs from Mo to Fr (workday group) and switch off at 18.00 hrs. In addition it has to operate on Saturday from 10.00 to 14.00 hrs.

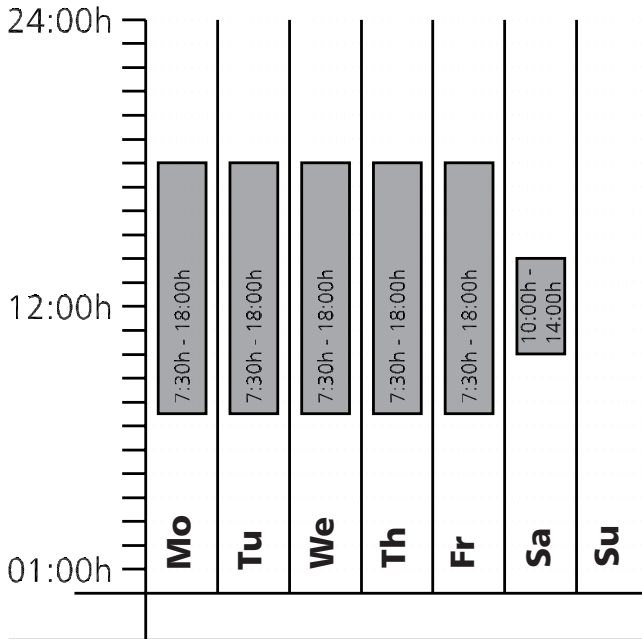

| | |
|---|--|
| <p>1. Select operating mode "Weekly programmer" After holding down the SET key (approx. 3 sec) the current operating mode is flashing. Select operating mode "Weekly programmer" with the push/turn control while holding down the SET key. After the SET key has been released the controller is in operating mode "Weekly programmer".</p> | |
| <p>2. Switch on at 07.30 hrs Mo-Fr Turn the push/turn control anticlockwise to select the symbols "Mo-Fr on" (workday group). Hold down the SET key and use the push/turn control to set the switch-on time to 7:30.</p> | |
| <p>3. Switch off at 18.00 hrs Mo-Fr Using the push/turn control select the symbols "Mo-Fr off" (workday group). Hold down the SET key and use the push/turn control to set the switch-off time to 18:00.</p> | |
| <p>4. Switch on at 10.00 hrs Sa Using the push/turn control select the symbols "Sa on". Hold down the SET key and use the push/turn control to set the switch-on time to 10:00.</p> | |
| <p>5. Switch off at 14.00 hrs Sa Using the push/turn control select the symbols "Sa off". Hold down the SET key and use the push/turn control to set the switch-off time to 14:00 hrs.</p> | |

10. Ramp timer

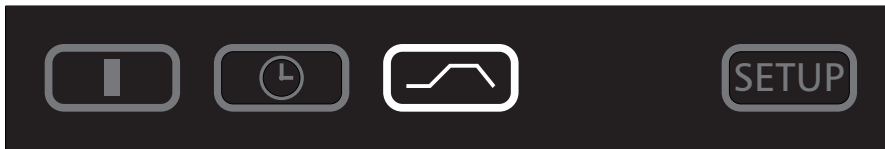

In this operating mode a fixed ramp sequence is programmed. A time period can be input for each ramp segment, or the appropriate ramp segment can be de-activated by setting "----". After the end of the programme the oven switches off the heating and cools down to ambient temperature. In the case of ovens UFE and SFE the fan runs on for 30 minutes.

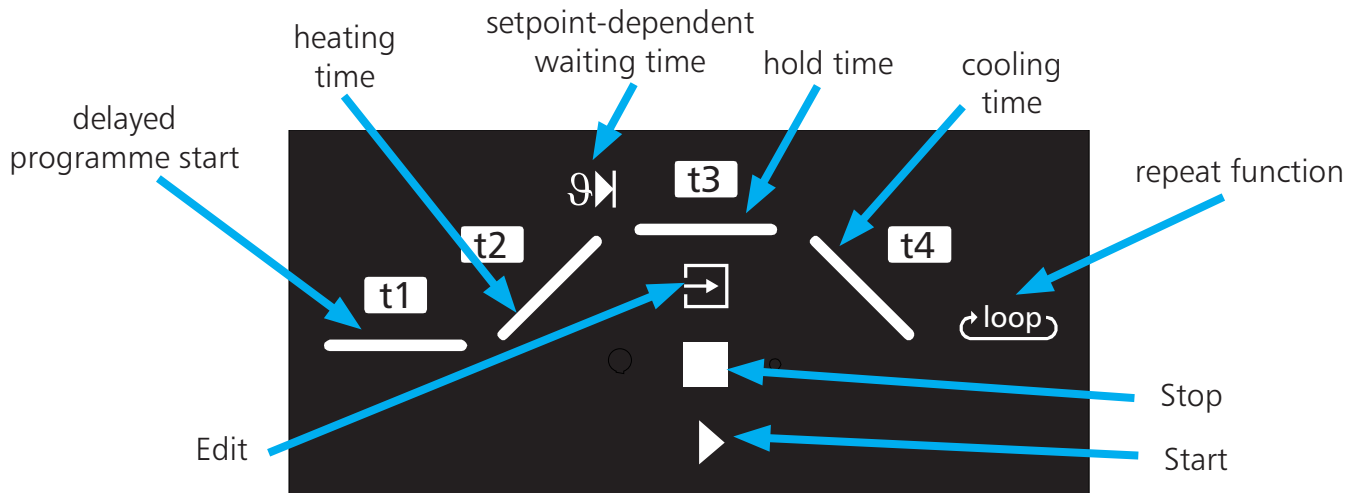

By turning the push/turn control the following parameters can be selected and can be altered as described in the Section "Selecting the parameters":

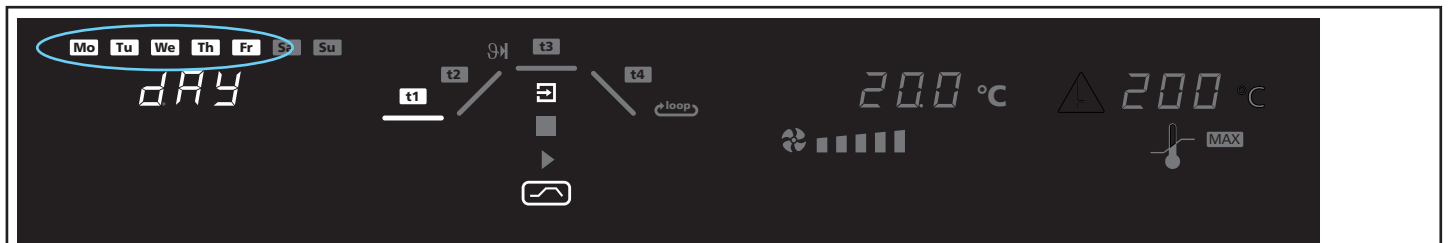

Delayed programme start **t1** : switch-on day

Range: Monday to Sunday, workdays Mo-Fr, weekend Sa-Sun, all days Mo-Su or no day. If no day of the week is selected, the oven starts up immediately after the programme is started.

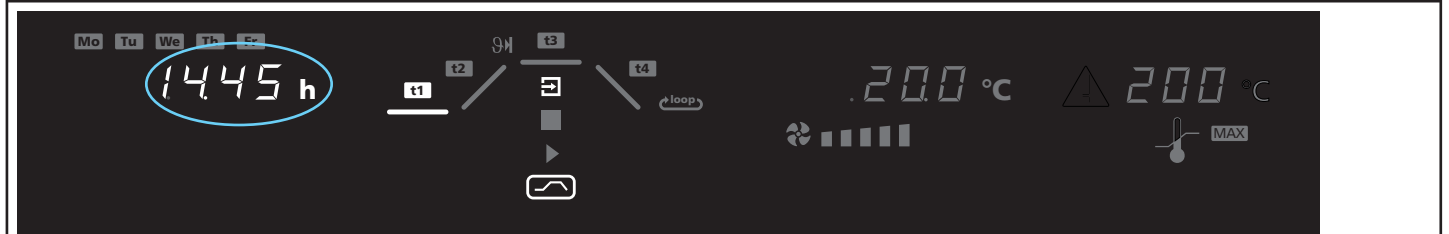

Delayed programme start **t1** : switch-on time

Range: 00:00 to 23:59

If no switch-on day has been selected it is not possible to select a switch-on time, and the programme starts immediately.

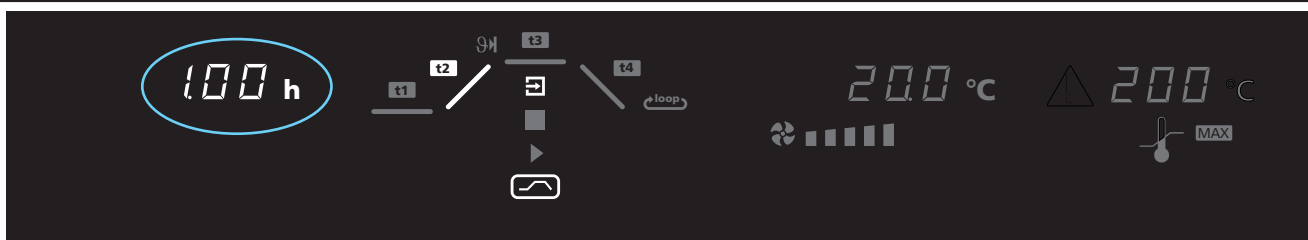

Heating time = heating up to setpoint temperature **t2**

Range:

no heating time OFF or 1 minute to 999 hours

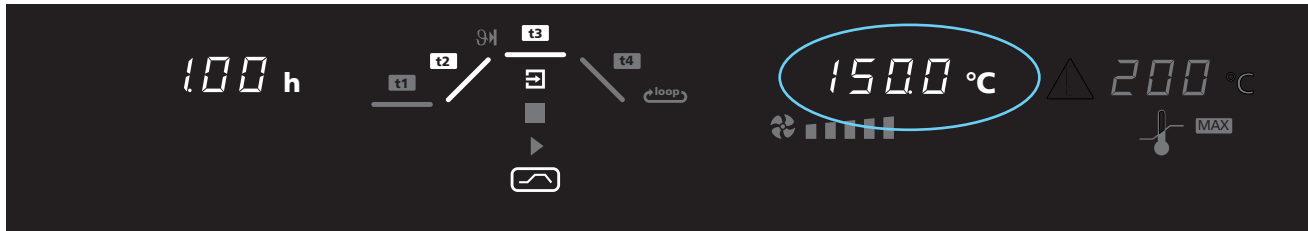

Setpoint temperature

Range: 20°C to nominal temperature (details see label)

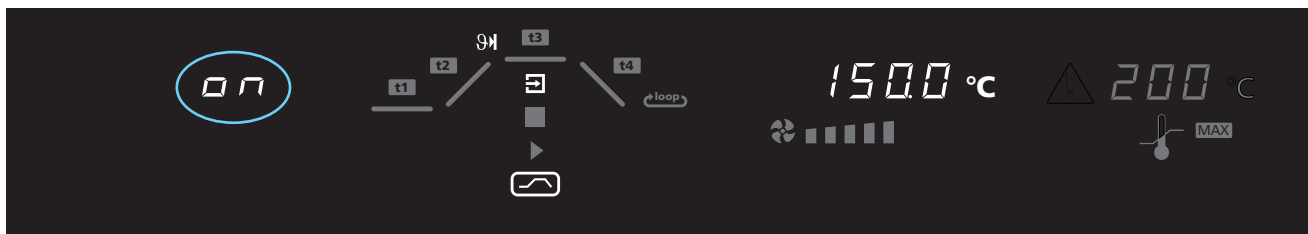

Setpoint-dependent waiting time **ON**

The oven starts the hold time t3 only when the selected setpoint temperature has been reached, even if this exceeds the time selected at t2 (see programming example)

Range: ON or OFF

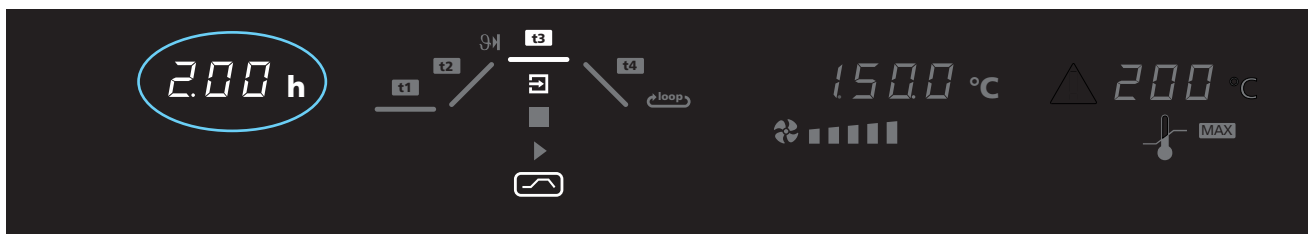

Hold time = maintain setpoint temperature **t3**

Range: from 1 minute to 999 hours or no hold time ----

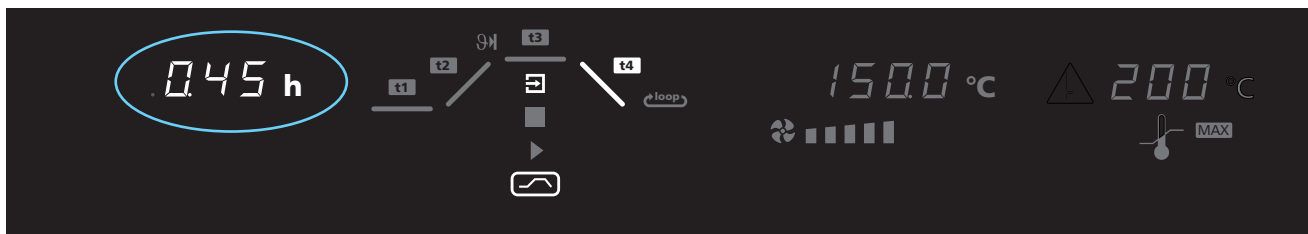

Cooling time = cooling down to ambient temperature **t4**

Range: from 1 minute to 999 hours or no cooling time ---

If no time is selected, the oven cools down naturally to ambient temperature

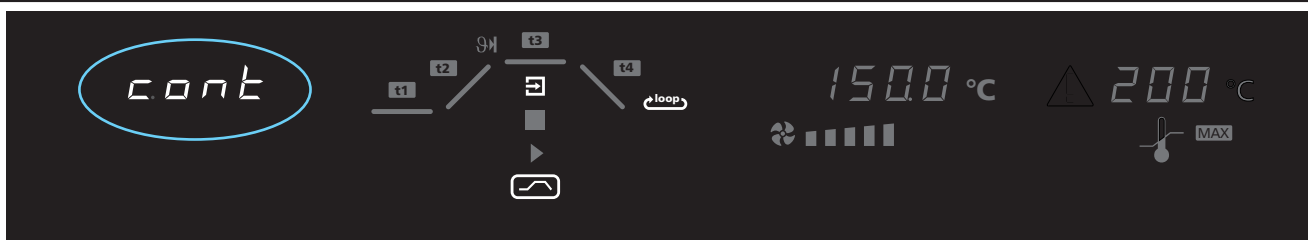

 Number of ramp repeats

Range:

OFF = no repeat function

1-99 = number of repeats

CONT = continuous repeat function



Fan speed (UFE/SFE only) 

Range:

0 – 100% in 10% steps

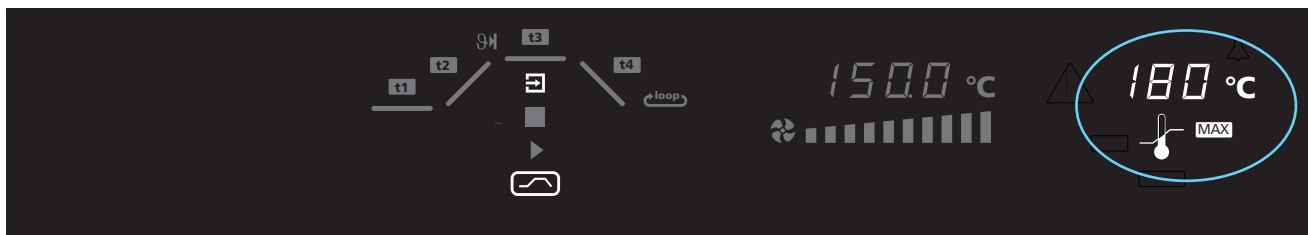

Monitor temperature 

Range: up to 10°C above nominal temperature (details see label).

see Section: "Temperature monitor"

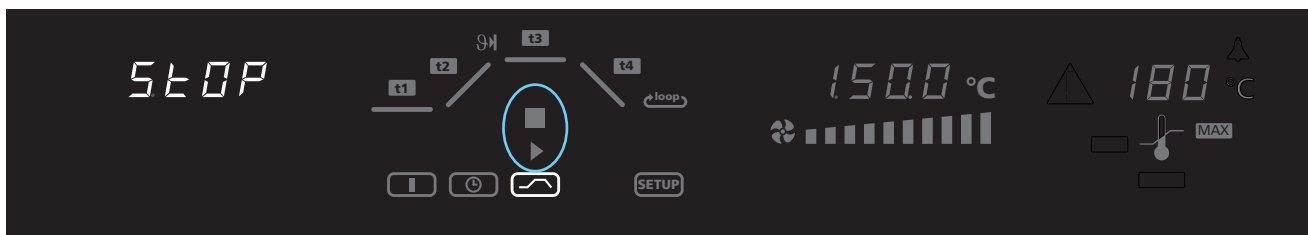

Start the programme

Turn push/turn control clockwise until the stop symbol  is flashing.

Hold down the SET key and with the push/turn control select start  anwählen.

Programming possibilities of ramp timer

Different choice of  and delayed programme start  offer the following programming possibilities:

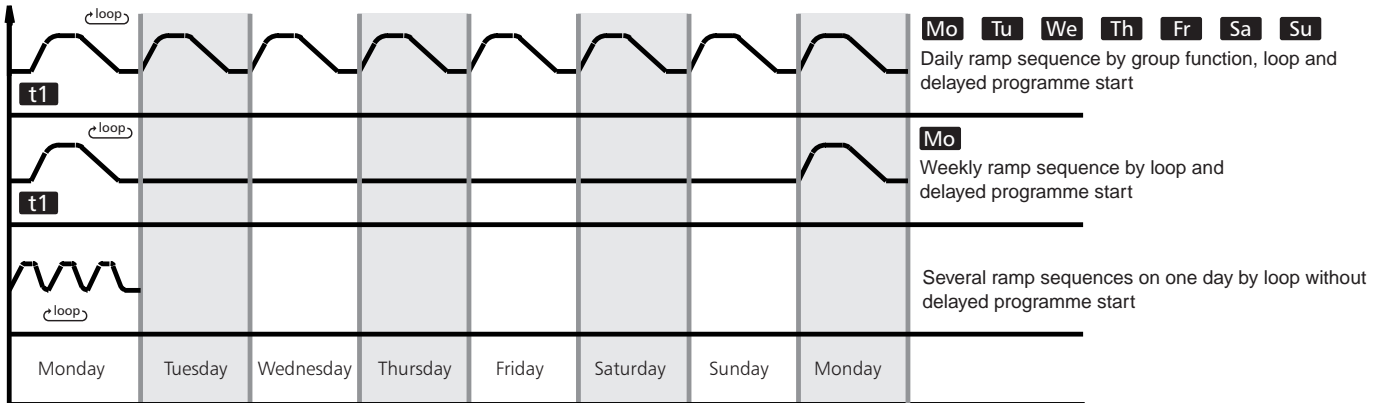



Programming example "Ramp timer"

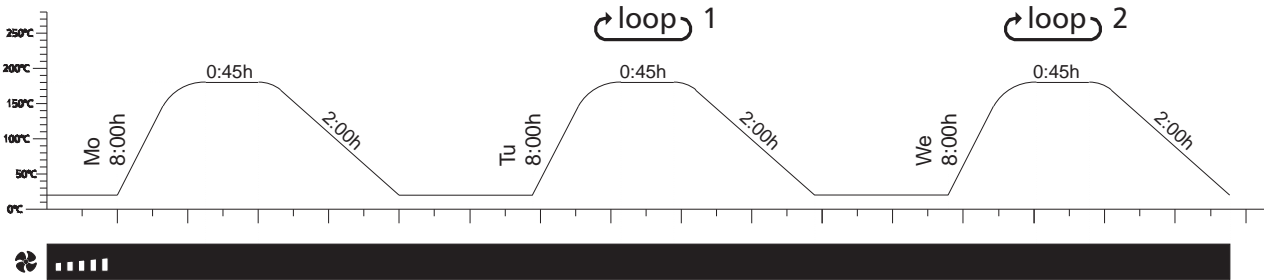

The oven (UFE500) has to heat up as quickly as possible to 180°C on Monday at 08.00 hrs with a fan speed of 50%. After reaching the setpoint temperature this has to be held for 45 minutes, followed by cooling down over two hours.

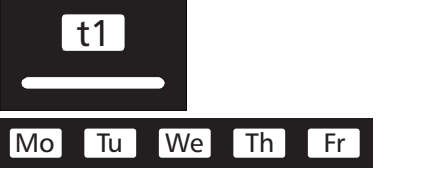
This programme has to be repeated on Tuesday and Wednesday.

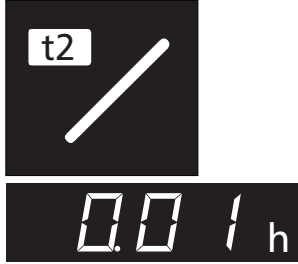
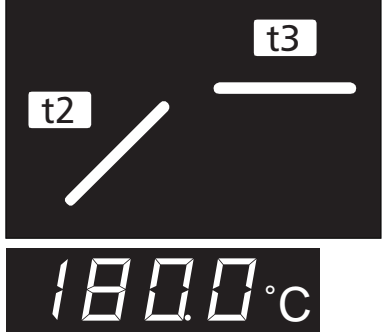
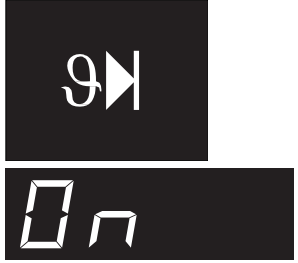
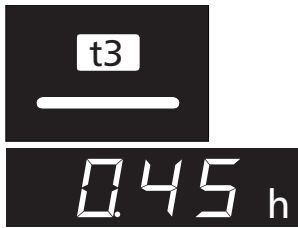
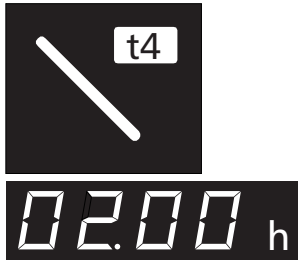
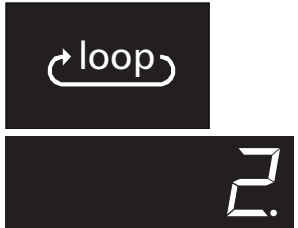

| | |
|--|---|
| <p>1. Select operating mode "Ramp timer" After holding down the SET key (approx. 3 sec) the current operating mode is flashing. Hold down the SET key and select operating mode "Ramp timer" using the push/turn control. After the SET key has been released the controller is in operating mode "Ramp timer".</p> |  |
| <p>2. Switch-on day for delayed programme start Using the push/turn control select the ramp segment "t1". Hold down the SET key and set the workdays group using the push/turn control.</p> |  |
| <p>3. Select switch-on time for delayed programme start Hold down the SET key and set the time 08:00 using the push/turn control.</p> |  |

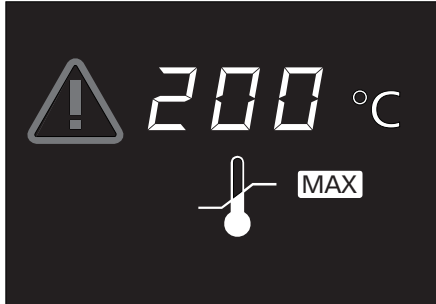
| | |
|--|---|
| <p>4. Select heating time t2</p> <p>Using the push/turn control select the ramp segment "t2". Hold down the SET key and using the push/turn control set the time 00:01. (1 minute is sufficient since a setpoint-dependent waiting time is being set.)</p> |  |
| <p>5. Select setpoint temperature</p> <p>Turn push/turn control clockwise until the temperature display is flashing. Hold down the SET the key and set the required temperature setpoint of 180°C using the push/turn control.</p> |  |
| <p>6. Select setpoint-dependent waiting time</p> <p>Using the push/turn control select the symbol for setpoint-dependent waiting time. Hold down the SET key and set 0n using the push/turn control. After the SET key has been released the function for setpoint-dependent waiting time is stored. This ensures that, as rapidly as possible and immediately on reaching the setpoint temperature, the oven holds the temperature for 45 minutes (as selected above).</p> |  |
| <p>7. Select hold time t3</p> <p>Using the push/turn control select the ramp segment "t3". Hold down the SET key and set the time 00:45 using the push/turn control.</p> |  |
| <p>8. Select cooling time t4</p> <p>Using the push/turn control select the ramp segment "t4". Hold down the SET key and set the time 02:00 using the push/turn control.</p> |  |
| <p>9. Select programme repeats</p> <p>Using the push/turn control select the loop symbol. Hold down the SET key and set 2 repeats using the push/turn control.</p> |  |









| | |
|--|---|
| <p>10. Select fan speed</p> <p>Turn the push/turn control clockwise until the fan symbol is flashing. Hold down the SET key and set fan speed 50% using the push/turn control.</p> |  |
| <p>11. Select monitor temperature</p> <p>Turn the push/turn control clockwise until the monitor temperature display is flashing. Hold down the SET key and set the monitor temperature to 200°C using the push/turn control.</p> |  |
| <p>12. Start the programme</p> <p>Turn the push/turn control clockwise until the stop symbol ■ is flashing. Hold down the SET key and select start ► using the push/turn control. On releasing the SET key the programme starts to run.</p> |  |

11. Basic oven settings SETUP



In this operating mode it is possible to make the basic settings for the oven. Clock time, date, day, year and calibration are set here.

The following parameters can be selected by turning the push/turn control, and altered as described in the Section ["Setting the parameters"](#):

| | | |
|---|---|---|
| <p><u>Clock time in 24-hour format</u> The winter/summer time changeover does not take place automatically but must be set manually by the user.</p> |  |  |
| <p><u>Date</u> The controller incorporates a calendar which automatically allows for the different lengths of the months and also for leap years.</p> |  |  |
| <p><u>Weekday</u></p> |  |  |
| <p><u>Year</u> Range: from 2000 to 2100</p> |  |  |
| <p><u>Calibration temperature and calibration correction for user-calibration</u> CAL1 to CAL3 (see Section: "Calibration")</p> | |  |

11.1 Real-time clock

The real-time clock is set in SETUP and includes date and clock time.

The real-time clock serves for reports according to GLP.

Date and clock time are marked in the report memory.

On the graphics print from the PC the time axis is marked in real-time.

The clock runs with a buffer battery independently of the mains power supply.

The built-in lithium battery Type CR 2032 has a life of approx. 10 years.

12. Temperature monitor and protection devices

The monitor temperature is measured with a separate PT100 temperature sensor inside the chamber. The monitor unit provides protection for the oven load as well as protection for oven and its surroundings.

The oven is provided with duplicate overtemperature protection (mechanical / electronic) according to DIN 12 880.

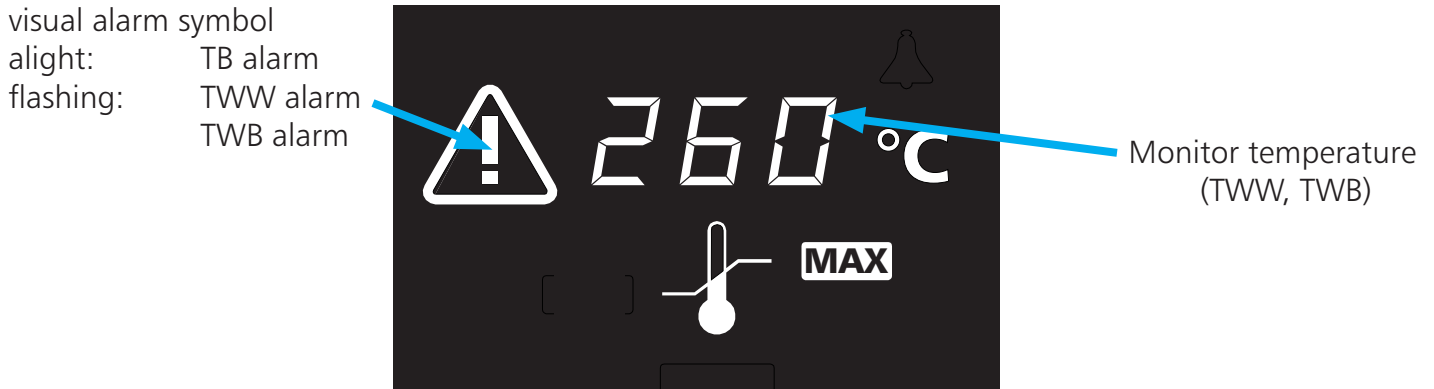

12.1 Mechanical temperature monitor: temperature limiter (TB)

All ovens of the EXCELLENT series are equipped with a mechanical temperature limiter (TB) Protection Class 1 to DIN 12 880.

If the electronic monitor system should fail during operation and the fixed factory-set maximum temperature is exceeded by approx. 20°C the temperature limiter switches off the heating permanently as a final protective measure. The alarm symbol lights up as warning

1. Fault rectification after the TB cut-out has been activated:
2. Switch off the oven and allow it to cool down
3. Rectify the fault (e.g. replace temperature probe) and where appropriate contact customer service
4. The oven is again ready for operation only after it has cooled down and after the fault has been rectified.

12.2 Electronic temperature monitor

| | | |
|---|--|---|
| <p>Monitor temperature</p> <p>Range: up to 10°C max above nominal temperature (for nominal temperature see label)</p> | | <p>Using the push/turn control select the symbol MAX.</p> <p>Hold down the SET key and set the protection temperature using the push/turn control.</p> |
|---|--|---|

Note:

The temperature monitor can be set independently of the operating mode.

During ramp operation the monitor temperature must always be set sufficiently far above the maximum working temperature.

The manually set monitor temperature **MAX** of the electronic overtemperature protection system is monitored, in the case of EXCELLENT ovens, by an adjustable temperature monitor (TWW) Protection Class 3.1 to DIN 12 880, or as an option by an adjustable temperature limiter (TWB) Protection Class 2 to DIN 12 880. For details of temperature monitor system and Protection Class see label.

Adjustable temperature monitor (TWW) Protection Class 3.1 to DIN 12 880

If the manually set monitor temperature **MAX** is exceeded, the TWW takes over the control of the temperature and starts to control at the monitor temperature. As a warning the alarm symbol  is flashing.

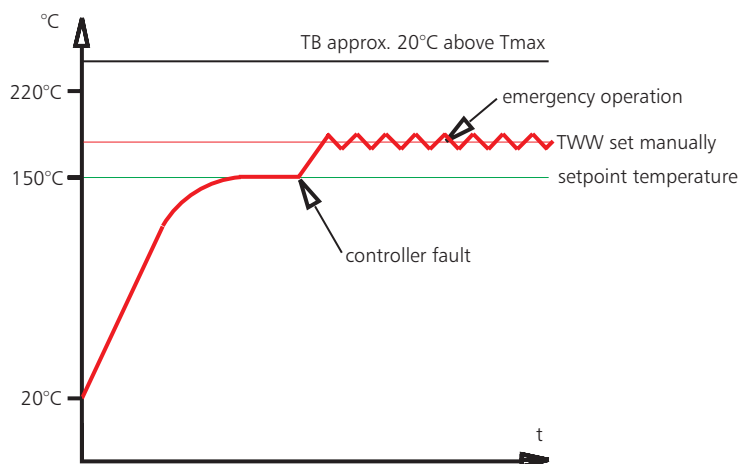

Adjustable temperature limiter (TWB) Protection Class 2 to DIN 12 880 (option)

If the manually set monitor temperature **MAX** is exceeded, the TWB switches off the heating permanently and can only be reset by pressing the SET key. As a warning the alarm signal  is flashing.

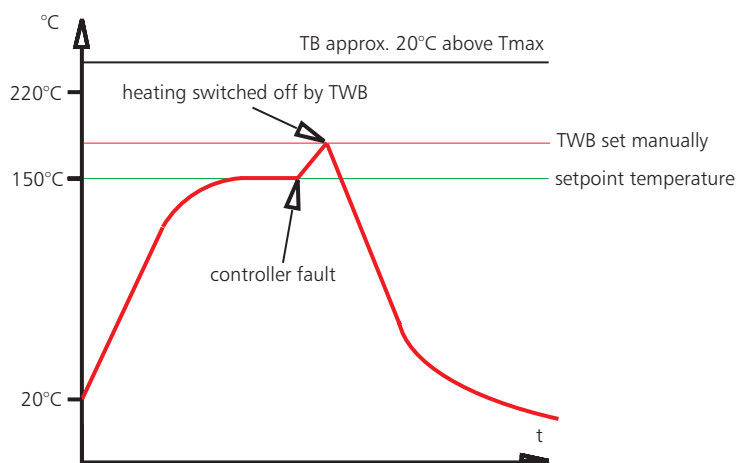

13. Calibration

User-calibration of oven and controller, with three calibration temperatures selected by the user.

CAL.1 temperature calibration at low temperature

CAL.2 temperature calibration at medium temperature

CAL.3 temperature calibration at high temperature

Either a positive or a negative calibration correction can be applied to each selected calibration point.

General calibration instructions:

1. Select the required calibration temperature in SETUP and set the corresponding calibration correction to 0.0°C.
2. Measure the deviation from the selected calibration temperature under steady conditions, using a reference instrument.
3. Set the calibration correction in SETUP. If the measured reference temperature is too low, the calibration correction setting has to have a positive sign.
4. Carry out a check measurement using the reference meter.
5. The procedure can be carried out for up to 3 calibration temperatures.

Example: Correction of a temperature deviation in the load at 100°C.

1. Set calibration temperature **CAL.2** to 100.0°C in SETUP and set the corresponding calibration correction to 0.0°C.
2. Using a calibrated reference instrument, an actual temperature of 100.4°C is measured in normal operation for a setpoint temperature of 100°C.
3. In SETUP set the calibration correction for **CAL.2** to -0.4°C.
4. After the oven has settled down the reference instrument should read 100.0°C.
5. With **CAL.1** a further calibration temperature can be programmed below **CAL.2**, and with **CAL.3** an additional calibration temperature above **CAL.2**.

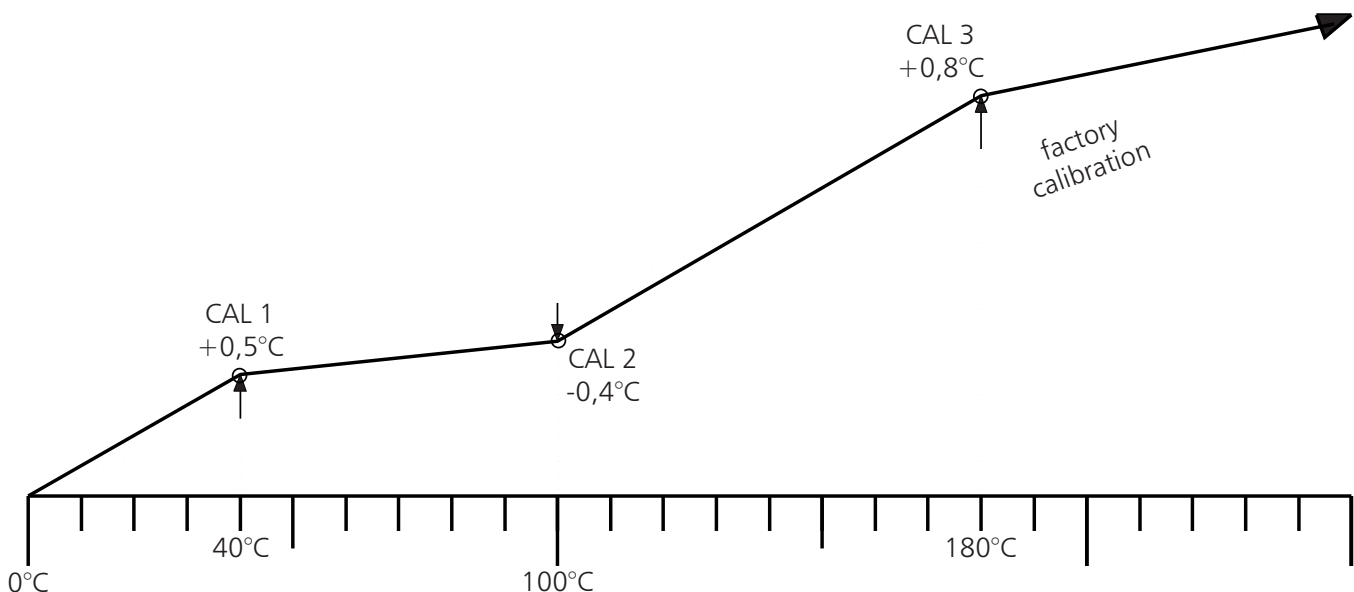

Note:

If all calibration corrections are set to 0.0°C the factory calibration is restored.

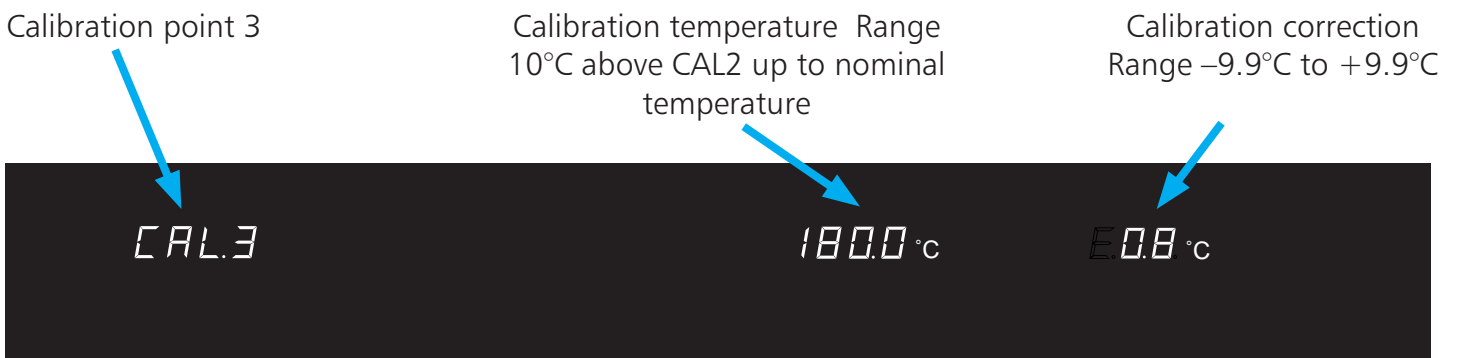
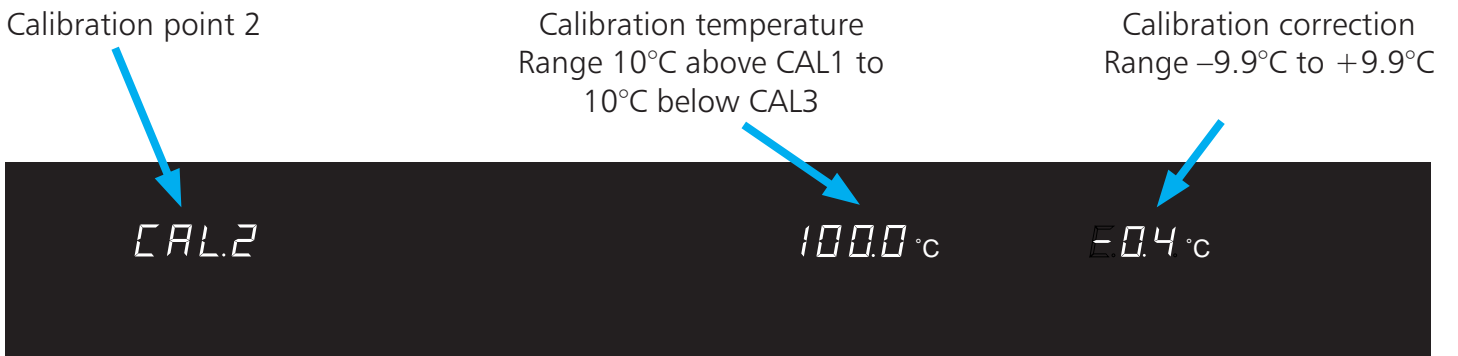
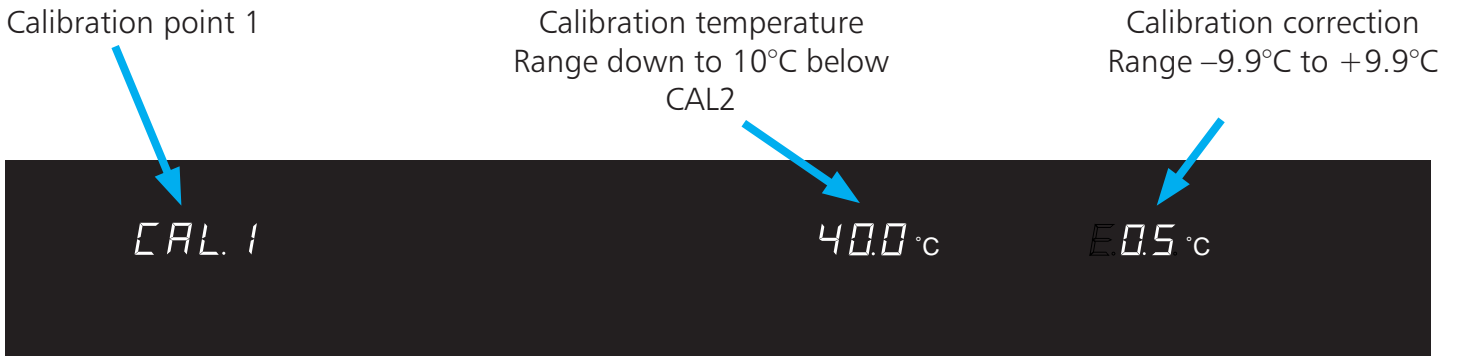

14. Communication interface RS232C for the PC

The oven is provided as standard with a serial communication interface RS232C according to DIN 12 900-1. Using this interface it is possible to control the oven from the PC and to produce reports. This is done using the "Celsius 2005" software.

If several ovens are connected by the RS232C interface to one PC, each oven requires a corresponding interface on the PC as well as a separate cable.

The maximum cable length is 15 m.

For connection of the oven to the PC there is a 9-pin connector on the back of the oven. The oven can be connected to the PC using a screened interface cable. The screen has to be connected to the plug case. If the serial interface is not being used the cover supplied has to be fitted !

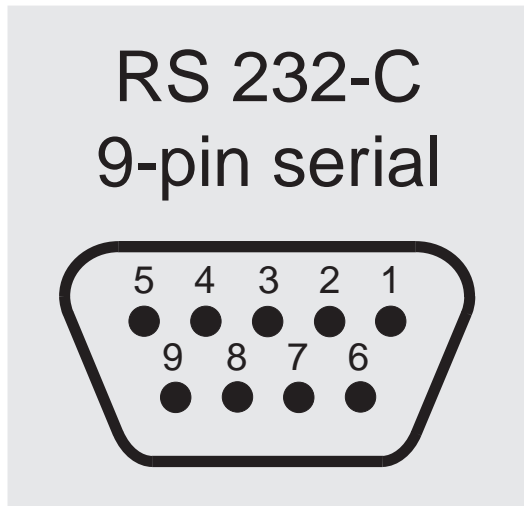

| 1 | 2 | 3 | 4 | 5 | 6 | 7 | 8 | 9 |
|----------|-----|-----|----------|-----|----------|----------|----------|----------|
| not used | RXD | TXD | not used | GND | not used | not used | not used | not used |

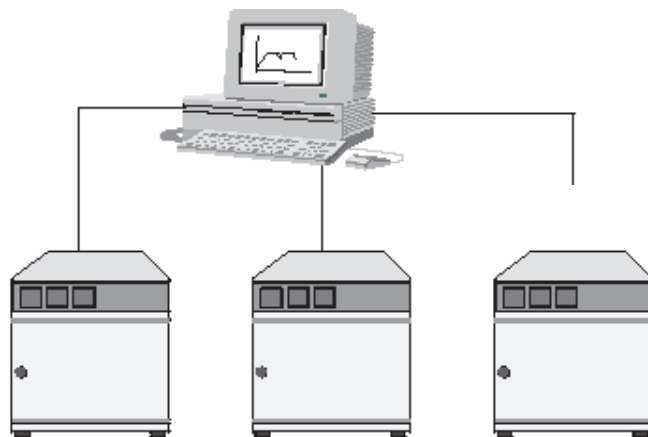

15. Report memory

The controller continuously records all relevant measurements, settings and error messages at 1-minute intervals.

The internal report memory is arranged as a ring memory, i.e. the new data always overwrite the oldest report data.

The report function can not be switched off but remains active at all times. The data are stored in the controller, protected against any manipulation. The controller memory can be read to produce documentation.

Every data set is stored with a unique date stamp.

The size of the internal report memory is 1024kB. This corresponds to a memory capacity of approximately 6 months' continuous operation.

During ramp operation a larger amount of data are stored in the memory so that the maximum report duration may be reduced.

If the power supply is interrupted, the instants of power failure and restoration of power are stored in the controller.

15.1 Reading the report memory into the PC via RS232C

Using the "Celsius 2005" program the record memory of the controller can be read via the RS232C interface into a PC where it can be shown graphically, printed, and stored in memory.

Note:

The report memory of the controller is not altered or cleared by the reading procedure.

16. Sterilisers

16.1 Purpose definition for MEMMERT hot air sterilisers

The oven SNE/SFE is intended for the sterilisation of medical materials by dry heat using hot air at atmospheric pressure.

16.2 Guidelines for sterilisation in MEMMERT hot air sterilisers

For hot air sterilisation there are different regulations covering the temperature settings and the sterilisation times, as well as the packaging of the products to be sterilised. The values to be selected depend on the type and condition of the load to be sterilised and on the type of bacteria which have to be de-activated. Please make yourself familiar with the sterilisation method laid down for your application before carrying out sterilisation using your MEMMERT cabinet.

The operation of the MEMMERT hot air steriliser is also subject to the Standard DIN 58 947 Part 6.

A few examples of the correct preparation for different medical products are summarised in the following table:

| Load | Preparation |
|------------------------------|--|
| Instruments (no soft solder) | load cleaned instruments, wrapped twice in aluminium foil or in steriliser foil suitable for hot air (recommended) |
| Cutting instruments | load cleaned instruments, wrapped twice in aluminium foil or in steriliser foil suitable for hot air (recommended) |
| Syringes (no plastics) | load plunger and cylinder separately, wrapped twice in aluminium foil or in steriliser foil suitable for hot air (recommended) |
| Glass and glass instruments | dismantle cleaned glass vessels and all-glass syringes and place into dishes, cool down slowly |

Bottles, vessels and similar items must be sterilised without closure and with the opening downwards, in order to avoid the formation of cold air pockets. The recommended sterilisation temperature is usually 180°C (German Pharmacopoeia DAB 10).

Sterilisation should in all cases be carried out as setpoint-dependent operation, according to the following example. The holding time to be selected consists of the stabilisation time (i.e. the time until the desired temperature has been established within the entire steriliser chamber), the actual sterilisation time, and a safety margin.

The following table gives typical values for the holding time to be set, with different amounts of load, for sterilisers with and without fan. Please note that these values can be employed only with correct and loose distribution of the load. Notes on the correct loading of the steriliser can be found in these Operating Instructions and also on the label affixed to the steriliser.

| Sterilisation temperature: 180°C | Type of loading: | | | | | |
|----------------------------------|------------------|----------|-------------|----------|-------------|----------|
| | light | | medium | | heavy | |
| Steriliser size | without fan | with fan | without fan | with fan | without fan | with fan |
| 200 | 0:50 h | ---- | 1:20 h | ---- | 1:50 h | ---- |
| 300 | 0:50 h | ---- | 1:20 h | ---- | 1:50 h | ---- |
| 400 | 1:10 h | 1:00 h | 1.50 h | 1.20 h | 2:00 h | 1:50 h |
| 500 | 1:10 h | 1:00 h | 1.50 h | 1.20 h | 2:00 h | 1:50 h |
| 600 | 1:30 h | 1:00 h | 2.20 h | 1.30 h | 2:20 h | 2.20 h |
| 700 | 1:30 h | 1:00 h | 2.20 h | 1.30 h | 2:20 h | 2.20 h |
| 800 | 1:40 h | 1:10 h | 2.20 h | 1.40 h | 2:50 h | 2.20 h |

The sterilisation time is increased by a factor of 4 when sterilising at a temperature of 160°C. On large sterilisers and with heavy loading it is recommended to use wire shelves (special accessory) instead of perforated shelves.

Especially with heavy loading of the steriliser it is not sufficient to use these typical values without further tests. Reliable sterilisation requires validation of the individual sterilisation process, e.g. with the aid of additional temperature probes or by using biological or chemical indicators.

In sterilisation processes the vent valve on the oven must be closed after the moist sterilisation load has been dried.



WARNING!



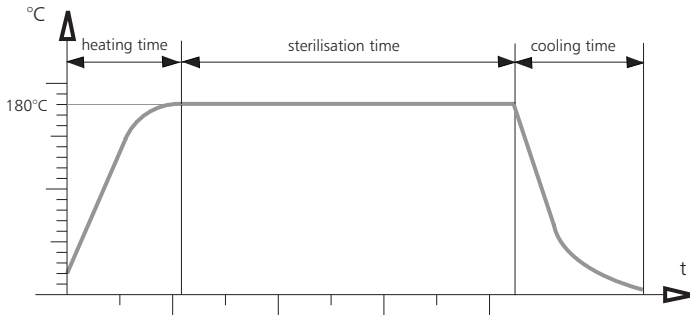

Models SNE700/800 and SFE700/800 are fitted with lockable doors. If the user, against our express warning, enters the steriliser chamber he must first remove the key and carry it on his person.

Programming example steriliser

The steriliser (SFE600) has to sterilise at a temperature of 180°C and a medium quantity of load for one hour and 30 minutes. By setting a cooling time of 2 hours the load can only be removed after it has cooled down.

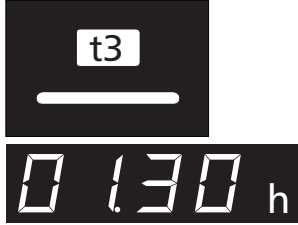
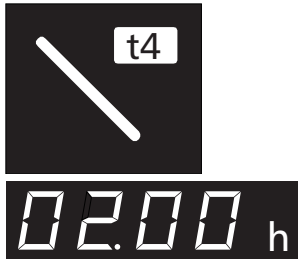

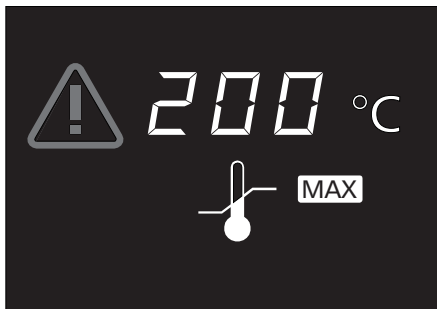
| | |
|---|--|
| <p>1. Select operating mode "Ramp timer"</p> <p>After holding down the SET key (approx. 3 sec) the current operating mode is flashing. Hold down the SET key and select operating mode "Ramp timer" using the press/turn control.</p> | |
| <p>2. No switch-on day for delayed programme start</p> <p>The sterilisation programme has to start immediately, therefore no day is selected for ramp segment "t1" with the push/turn control.</p> | |
| <p>3. Select heating time t2</p> <p>Using the push/turn control select the ramp segment "t2". Hold down the SET key and using the push/turn control set the time 00:01. (1 minute is sufficient since a setpoint-dependent waiting time is being set).</p> | |
| <p>4. Select setpoint temperature</p> <p>Turn the push/turn control clockwise until the temperature display is flashing. Hold down the SET key and set the required temperature setpoint of 180°C using the push/turn control.</p> | |
| <p>5. Select setpoint-dependent waiting time</p> <p>Using the push/turn control select the symbol for setpoint-dependent waiting time. Hold down the SET key and set 0n using the push/turn control. After the SET key has been released the function for setpoint-dependent waiting time is stored, ensuring that the sterilisation time only begins when the selected temperature setpoint has been reached.</p> | |

| | |
|--|---|
| <p>6. Select hold time t3 Using the push/turn control select the ramp segment "t3". Hold down the SET key and set the time 01:30 using the push/turn control.</p> |  |
| <p>7. Select cooling time t4 Using the push/turn control select the ramp segment t4. Hold down the SET key and set the time 02:00 using the push/turn control.</p> |  |
| <p>8. Select fan speed Turn the push/turn control clockwise until the fan symbol is flashing. Hold down the SET key and set fan speed 50% using the push/turn control.</p> |  |
| <p>9. Select monitor temperature Turn the push/turn control clockwise until the monitor temperature display is flashing. Hold down the SET key and set the monitor temperature to 200°C using the push/turn control.</p> |  |
| <p>10. Start the programme Turn the push/turn control clockwise until the stop symbol ■ is flashing. Hold down the SET key and select start ► using the push/turn control. On releasing the SET key the programme starts to run.</p> |  |

16.3 Steriliser cassettes

The cassettes should preferably be so arranged in the steriliser that the hot air flow can pass readily through the air slots.

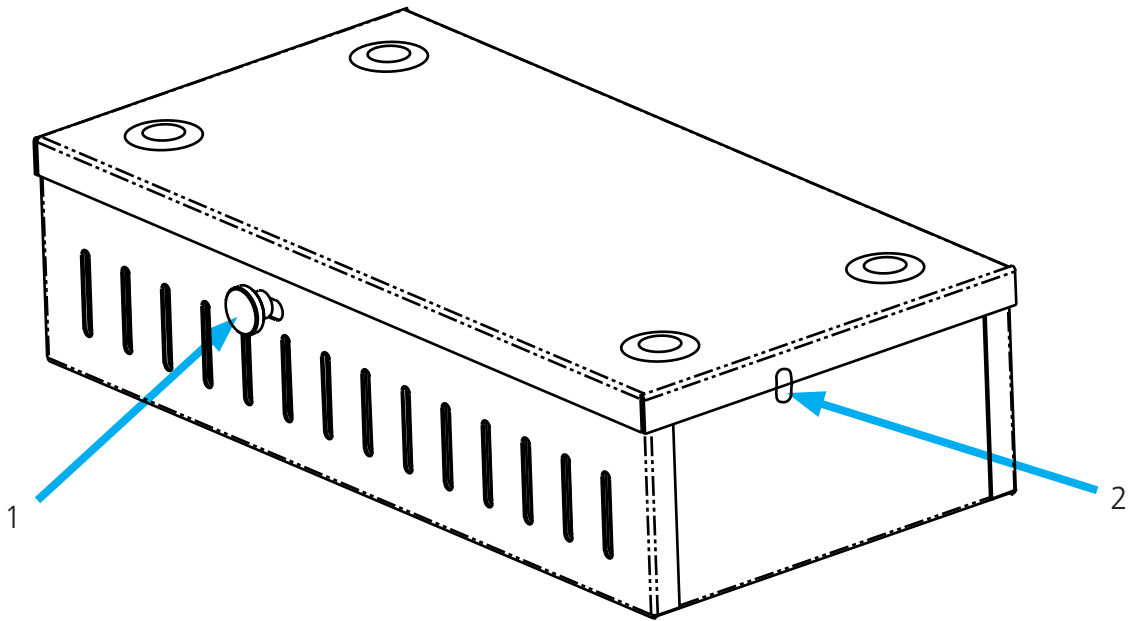

The load to be sterilised is placed into the steriliser cassettes wrapped in aluminium foil or in steriliser foil suitable for hot air (as in the Table in the Section “Guidelines for sterilisation”). The air slots in the cassette must be open for sterilisation.

A temperature probe to confirm the temperature of the load can be introduced through the opening (2). After sterilisation has been completed the air slots must be closed by moving the slide knob (1). The sterilised and packed load can then be stored briefly in the closed cassette.

17. Cleaning

Regular cleaning of the easy-to-clean inside of the chamber prevents deposits which over time can detract from the appearance and the functionality of the stainless steel chamber .

The metal surfaces of the oven can be cleaned with commercially available cleaning agents for stainless steel. It is important to ensure that no rust-forming object comes into contact with the chamber or the stainless steel casing. Rust deposits cause infection of the stainless steel.

If any contamination causes rust stains on the surfaces of the chamber, such spots must be cleaned off immediately and the area polished.

WARNING !

The control panel, the plastic input modules and other plastic components of the oven must not be cleaned using scouring cleaning agents or those containing solvents.

18. Maintenance

Important for a long life of your MEMMERT product and in case of warranty claims.

Any work involving opening up the oven must only be carried out by a suitably qualified electrician.

MEMMERT products require little maintenance. It is however recommended to lubricate all moving parts of the doors (hinges and closure) once a year (or 4 times a year with continuous operation) using a thin Silicone grease, and to check that the hinge screws are tight.

A well-closing door is essential on an oven. On Memmert ovens, tight closure of the door is ensured by a seal on the oven and another one on the door. In continuous operation the flexible sealing material may take a permanent set. Readjustment may then be necessary in order to ensure proper closing of the door.

- The top part (1) of the door hinge can, after releasing the 2 screws (2) at the top or bottom of the door, be moved slightly in the direction of the arrow.
- The door can be adjusted after releasing the socket screw (3) and rotating the excentric (4) by means of a screwdriver. NOTE ! Screw (3) is locked with locking varnish. It can be released by a sharp tug using a hexagon socket key. Apply more locking varnish to screw (3) and tighten it.

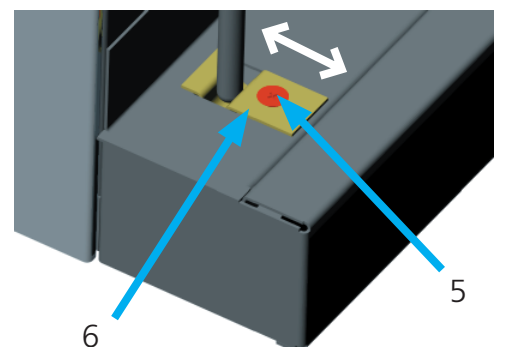
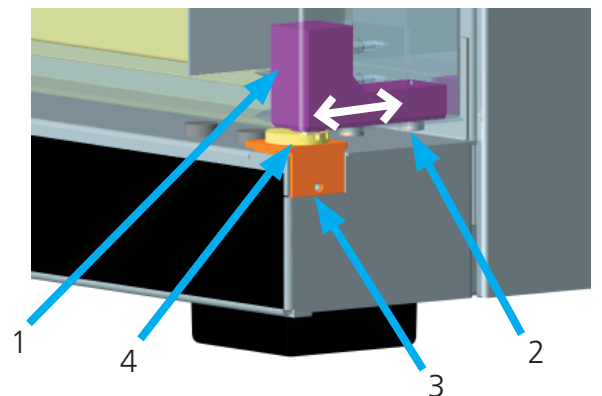

The closing panel (6) can also be adjusted in the direction of the arrow after releasing the screw (5). It is important that the panel is then screwed down firmly.

19. Error messages

| | |
|------|---|
| E-0 | Error on self test |
| E-1 | Power module triac faulty |
| E-2 | Power module faulty |
| E-3 | PT100 temperature probe faulty |
| E-L1 | Fehler Kommunikation zum Leistungsteil L1 |
| E-L2 | Fehler Kommunikation zum Leistungsteil L2 |
| E-L3 | Fehler Kommunikation zum Leistungsteil L3 |
| E-LA | Fehler Kommunikation zu allen Leistungsteilen (evtl. Regler defekt) |

In case there is a fault on the oven, please get in touch with an authorised service organisation or contact the Memmert customer service department.

When dealing with the service department always quote the product serial number on the oven label.

20. Supply failure

Supply failure in operating mode "Normal operation"

After a supply failure the operation is continued with the set parameters. The instant and duration of the supply failure are documented in the record memory.

Supply failure in operating mode "Weekly programmer"

After a supply failure the operation is continued with the set parameters. The instant and duration of the supply failure are documented in the record memory.

Supply failure in programme operation

After a supply failure lasting less than 15 minutes the current programme is continued at the point where it was interrupted. The instant and duration of the supply failure are documented in the report memory.

After a supply failure of more than 15 minutes, the ovens starts in normal operation, for safety reasons, and all settings are set to safe default values.

Supply failure in remote operation

On a supply failure in remote operation the oven immediately starts in normal operation for safety reasons and all settings are set to safe default values (see table). Programme continuation has to take place from the PC. The instant and duration of the supply failure are documented in the report memory.

| Parameter | Default value |
|-------------|---------------|
| Temperature | 20 °C |
| Fan speed | maximum |



EC Declaration of Conformity

Manufacturer's name and address: MEMMERT GmbH + Co. KG
Äußere Rittersbacher Straße 38
D-91126 Schwabach

Product: Universal oven

Type: UNB ... / UFB ... / UNE ... / UFE ... / UNP ... / UFP ...

Sizes: 100 / 200 / 300 / 400 / 500 / 600 / 700 / 800

Nominal voltage: AC 230 V or 3 ~ AC 400 V 50 / 60 Hz
alternative AC 115 V 50/60 Hz

The designated product is in conformity with the European EMC-Directive

89/336/EEC
including amendments

Council Directive of 03 May 1989 on the approximation of the laws of the Member States relating to electromagnetic compatibility.

Full compliance with the standards listed below proves the conformity of the designated product with the essential protection requirements of the above-mentioned EC Directive:

| | |
|---|---------------------------|
| DIN EN 61 326 (VDE 0843 part 20): 1998-01 | EN 61 326: 1997 |
| DIN EN 61 326/A1 (VDE 0843 part 20/A1): 1999-05 | EN 61 326: 1997/A1 : 1998 |
| RFI suppression: Class B | |
| DIN EN 61 000-3-11 (VDE 0838 part 11): 2001-04 | EN 61 000-3-11: 2000 |

The designated product is in conformity with the European Low Voltage Directive

73/23/EEC
including amendments

Council Directive on the approximation of the laws of the Member States relating to Electrical equipment for use within certain voltage limits.

Full compliance with the standards listed below proves the conformity of the designated product with the essential protection requirements of the above-mentioned EC Directive:

| | |
|--|-----------------------|
| DIN EN 61 010-1 (VDE 0411 part 1): 1994-03 | EN 61 010-1: 1993 |
| DIN EN 61 010-2-010 (VDE 0411 part 2-010): 1995-03 | EN 61 010-2-010: 1994 |

Schwabach, 03.09.04



(Legally binding signature of the issuer)

This declaration certifies compliance with the above mentioned directives but does not include a property assurance. The safety note given in the product documentation which are part of the supply, must be observed.



EC Declaration of Conformity

Manufacturer's name and address: MEMMERT GmbH + Co. KG
Äußere Rittersbacher Straße 38
D-91126 Schwabach

Product: Incubators
Type: INB ... /INE ... / INP ...
Sizes: 200 / 300 / 400 / 500 / 600 / 700 / 800
Nominal voltage: AC 230 V 50/60 Hz
alternative AC 115 V 50/60 Hz

The designated product is in conformity with the European EMC-Directive

89/336/EEC
including amendments

Council Directive of 03 May 1989 on the approximation of the laws of the Member States relating to electromagnetic compatibility.

Full compliance with the standards listed below proves the conformity of the designated product with the essential protection requirements of the above-mentioned EC Directive:

| | |
|---|---------------------------|
| DIN EN 61 326 (VDE 0843 part 20): 1998-01 | EN 61 326: 1997 |
| DIN EN 61 326/A1 (VDE 0843 part 20/A1): 1999-05 | EN 61 326: 1997/A1 : 1998 |
| RFI suppression: Class B | |
| DIN EN 61 000-3-11 (VDE 0838 part 11): 2001-04 | EN 61 000-3-11: 2000 |

The designated product is in conformity with the European Low Voltage Directive

73/23/EEC
including amendments

Council Directive on the approximation of the laws of the Member States relating to Electrical equipment for use within certain voltage limits.

Full compliance with the standards listed below proves the conformity of the designated product with the essential protection requirements of the above-mentioned EC Directive:

| | |
|--|-----------------------|
| DIN EN 61 010-1 (VDE 0411 part 1): 1994-03 | EN 61 010-1: 1993 |
| DIN EN 61 010-2-010 (VDE 0411 part 2-010): 1995-03 | EN 61 010-2-010: 1994 |

Schwabach, 03.09.04



(Legally binding signature of the issuer)

This declaration certifies compliance with the above mentioned directives but does not include a property assurance. The safety note given in the product documentation which are part of the supply, must be observed.



EC Declaration of Conformity

Manufacturer's name and address: MEMMERT GmbH + Co. KG
Äußere Rittersbacher Straße 38
D-91126 Schwabach

Product: Steriliser

Type: SNB ... / SFB ... / SNE ... / SFE ... / SFP ...

Sizes: 100 / 200 / 300 / 400 / 500 / 600 / 700 / 800

Nominal voltage: AC 230 V oder 3 ~ AC 400 V 50 / 60 Hz
alternative AC 115 V 50/60 Hz

The product meets the regulations of the directive

93/42/EWG

Directive of the council to adapt legal regulations of the member states on the subject of medical products dd. 14.06.1993 (Abl. EG Nr. L 169, S. 1, 12.07.1993) including annex and modifications.

Schwabach, 24.01.05



(Legally binding signature of the issuer)

This declaration certifies compliance with the above mentioned directives but does not include a property assurance. The safety note given in the product documentation which are part of the supply, must be observed.

Standard ovens (UNE / UFE / INE) are safety-approved and bear the test marks:



Sterilisers (SNE / SFE) are safety-approved and bear the test marks:



22. Address and customer service

MEMMERT GmbH+Co.KG
PO Box 17 20
91107 Schwabach
Germany
Phone: (+49) (0)9122 / 925-0
Fax: (+49) (0)9122 / 14585
E-mail: sales@memmert.com
Internet: www.memmert.com

Customer service:
Phone: (+49) (0)9122 / 925-143
or (+49) (0)9122 / 925-126
E-mail: service@memmert.com

When contacting customer service, always quote the product serial number on the oven label.



23. Index

A

accessories 9
address 40
air changes 11
air supply 10
alarm indication 11
alarm symbol 24, 25

C

calibration 26
calibration correction 26
calibration temperature 26
CE conformity declaration 37
cleaning 35
clock time 23
communication interface 28
connection 8
construction, oven 10
controls 11
cooling time 17
customer service 40

D

date 23
day groups 15
delayed programme start 17
DIN 12 880 24
door 10
door handle 10

E

error messages 36

F

fan 10
fan indication 11

H

heating time 17
hold time 17

I

indications 11
initial start-up 5
installation facilities 9
interface, communication 28

L

load, oven 5

M

maintenance 35
material quality 4, 7
medical product 4
memory, report 29

N

normal operation 13

O

OFF time 15
ON time 15
operating mode, selection of 12
operating mode indication 11
operation 10
oven settings, basic 23

P

parameters, setting the 12
Protection Class 1 24
Protection Class 2 25
Protection Class 3.1 25
protection devices 24
purpose, intended 4, 30

R

ramp timer 17
real-time clock 23
repeat function 17
report memory 29
RS232C 28

S

setpoint-dependent waiting
time 17
settings, basic oven 23
SETUP 23
stacking 9
standard equipment 7
start-up 5
steriliser cassettes 34
sterilisers 30
subframe 9

T

TB 24
temperature, setting the 11
temperature calibration 26
temperature deviation 26
temperature display 11
temperature limiter 24
temperature monitor 24
temperature setpoint 11
time display 11
transport 4
TWB 25
TWW 25

W

wall bracket 9
weekday 15, 23
weekly programmer 15

Y

year 23

24.01.2005
EXCELLENT englisch

D09804